

GOVERNMENT OF INDIA

DEPARTMENT OF ARCHAEOLOGY

CENTRAL ARCHÆOLOGICAL
LIBRARY

CALL No. 913.38905/A.B.S.A
ACC. No. 31792

D.G.A. 79.

GIPN—S4—2D. G. Arch. N. D./57.—25-9-58—1,00,000.



1000

1000

1000

THE ANNUAL
OF THE
BRITISH SCHOOL AT ATHENS.

No. III.

31792

913.38005
A.B.S.A.

SESSION 1896-7

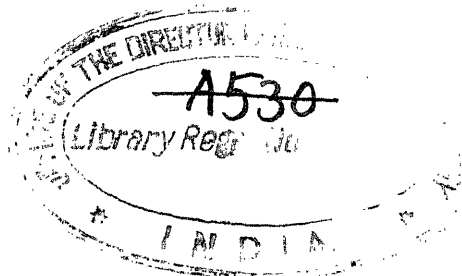

PRINTED FOR THE SUBSCRIBERS AND SOLD ON THEIR BEHALF BY
MACMILLAN & CO., LIMITED
LONDON

**CENTRAL ARCHAEOLOGICAL
LIBRARY, NEW DELHI.**

Acc. No......31792.....

Date.....18.6.57.....

Call No......913.38005/A.D.S.A.

Under Rule XXVII. it is provided that the Annual of the British School at Athens shall be edited by the Director of the School for the time being. The present volume is edited by Cecil H. Smith, the Director during 1896-7.

125 fols

TABLE OF CONTENTS.

	PAGE
1. CECIL SMITH. Excavations in Melos, 1897 (Plates I.—III.)	I
2. J. W. CROWFOOT. Excavations on the Demarch's Field, Melos	31
3. C. C. EDGAR. Prehistoric Tombs at Pelos	35
4. R. C. BOSANQUET. Notes from the Cyclades: (1) Pre-Mycenæan Pottery from Melos; (2) The so-called Kernoi; (3) Textile Impressions on Ægean Pottery; (4) Stone Dishes or Troughs; (5) A pre-Mycenæan Wrist-guard (Plates IV.—V.)	52
5. D. MACKENZIE. Ancient Sites in Melos	71
6. P. RODECK. The Ionic Capital of the Gymnasium of Kynosarges (Plates VI.—VIII.)	89
7. J. G. C. ANDERSON. An Epigraphic Miscellany	106
8. CECIL SMITH. A New Copy of the Athena Parthenos (Plate IX.)	121
9. C. A. HUTTON. On Three Bronze Statuettes (Plate X.)	149
10. PAUL F. PERDRIZET. Archaistic Reliefs (Plates XI.—XIII.)	156
11. J. L. MYRES. A Marble Relief from the African Tripolis (Plate XIV.)	170
12. A. M. POYNTER. Remarks on Three Sectile Pavements in Greece (Plate XV.)	175
13. CECIL SMITH. Panathenaic Amphoræ; and a Delos Mosaic (Plate XVI.)	182
14. CECIL SMITH. The Crucifixion on a Greek Gem	201
15. H. TRIANTAPHYLIDIS. Macedonian Customs	207
16. J. P. MAHAFFY. Prof. Jannaris' Historical Greek Grammar	215

Annual Meeting of Subscribers	221
Report of Director for Session 1896-7	228
Income and Expenditure	235
Donations and Subscriptions, 1896-7	237
List of Subscribers	240
List of Directors and Students	245
Rules and Regulations of the School	250
Index	253



LIST OF PLATES.

- I. Phylakopi; General Plan of the Foundations; drawn by C. R. R. Clark.
- II. Phylakopi; (*a*) Sections through the excavated portion, (*b*) General Plan; drawn by C. R. R. Clark.
- III. Bronze Statuette from Phylakopi, two views; from a photograph.
- IV. 1. Kernos in the Sèvres Museum; 2-4. Kernos in the British Museum (three views); drawn by F. Anderson.
- V. 1. Base of Vase from Tomb in Syra, and 2. Fragment from Phylakopi, showing Textile Impressions; drawn by F. Anderson. 3. Marble Trough from Amorgos, and 4. Marble Plate from Amorgos; drawn by C. J. Bell.
- VI. The Ionic Capital of the Gymnasium of Kynosarges, Athens; drawn by Pieter Rodeck.
- VII. Ionic Capital now in the Theatre of Dionysos, Athens; drawn by Pieter Rodeck.
- VIII. Comparison of Volutes of Ionic Capitals from Erechtheion, Kynosarges, and Theatre of Dionysos at Athens; drawn by Pieter Rodeck.
- IX. (*a*, *b*) Statuette of Athena Parthenos, at Patras.
- X. 1-3. Three Bronze Statuettes in Athens.
- XI. Relief at Aïdin (Tralles); drawn by F. Anderson.
- XII. (*a*) Relief from Aidin at Tchimli-Kiosk; (*b*) Relief in the possession of M. Duval at Morillon; from photographs.
- XIII. (*a*, *b*) Two Marble Reliefs at Tchimli-Kiosk; from photographs.
- XIV. Relief from the African Tripolis, in the possession of Mr. H. Swainson Cowper; from a photograph.
- XV. Roman Pavement in the Theatre of Dionysos, Athens; drawn by Ambrose Poynter.
- XVI. (*a*) Mosaic at Delos; (*b*, *c*) Fragments of Panathenaic Amphorae, (*b*) from Melos, (*c*) from Eleusis.

LIST OF ILLUSTRATIONS IN THE TEXT.

	PAGE
Terracotta Boat from Phylakopi, two views (F. Anderson)	23
Plan of Excavations in the Demarch's Field, Melos (C. R. Clark)	32
Pre-historic Vase from Pelos (F. Anderson)	38
Pre-historic Vases and Bead from Pelos (F. Anderson)	41
Outline Plan of Tombs at Pelos (F. Anderson)	41
Terracotta Object from Pelos (F. Anderson)	42
Pre-historic Vases from Pelos (F. Anderson)	44
Pre-historic Vases from Pelos (F. Anderson)	45
Pre-historic Vase from Pelos (F. Anderson)	48
Metal Objects from Antiparos (from a photograph by Miss Hutton)	49
Vases from a Grave at Phylakopi (F. Anderson)	53
Vase from the Kapro Cemetery at Phylakopi (C. R. Clark)	54
Vases from the Hill-Cemetery and Fortress at Phylakopi (C. R. Clark)	57
Vase found in a Grave at Syra (C. R. Clark)	62
Limestone Dish from Naxos (from Fiedler)	64
Sketch Map of Melos, showing Ancient Sites (P. Rodeck)	72
Inscribed Roof-tile from Kastriani, Melos (F. Anderson)	75
Coin-type of Elis, restored (F. Anderson)	89
Fac-simile of Lead Inscription from Kynosarges (C. Smith)	112
Fragment of Shield of the Patras Statue of Athena Parthenos (F. Anderson)	138
Patterns from a Delos Mosaic (C. Smith)	183
Intaglio with a Representation of the Crucifixion (F. Anderson)	201

EXCAVATIONS IN MELOS, 1897.

(PLATES I.—III.)

I.

AT the close of last year's Report (*British School Annual*, vol. ii., p. 76) it was stated that we had begun late in the season of 1896 an excavation on a site at Phylakopi, in the north-east of the island. The results then obtained were of so promising a character, that it was determined to constitute Phylakopi as the main objective of the campaign of 1897, and in fact to lay siege to the prehistoric fortress with all the forces at our disposition.

Unfortunately, when the season for excavation came round, the war-cloud had already burst, and digging, like other branches of scientific research in Greece, was for the time decidedly under the cloud. We were confronted by the fact that all the regular excavations in other parts of the country had been, for reasons of policy, suspended; we were assured that, all the able-bodied men being at the front, no labour would be obtainable: and we discovered for ourselves that the usual so-called "regular" lines of steamers plying to Melos were all disorganized or withdrawn. These difficulties, however, were comparatively trifling compared with those which we experienced when we eventually reached the island. As these difficulties were chiefly the result of a new ordinance of the General Ephor, and may at any future time be encountered by intending excavators in Greece, I may be allowed to indicate them briefly here for the benefit of all whom it may concern.

During the season of 1896 (and, I understand, for some years previously) all persons or societies allowed to excavate in Greece were expected to make their own arrangements with the proprietor of the

land on which the excavation was to be made: all objects excavated belonged by law to the proprietor, who could keep them if he chose; but in case of sale, the Government had the right of pre-emption on advantageous terms, and in case of sale to others (this right not being exercised), claimed a percentage of the value from the vendors. Under these conditions we dug in 1896, and on the whole found the system work fairly well; the Greek peasant proprietor is, as a rule, pleasant to deal with, and this arrangement, while it enabled him to confer a favour at small cost, also stimulated his healthy instincts of speculation and curiosity; for every well brought-up Greek believes that there is at least one gold statue in his field. So long as no gold statues were discovered, and only objects of comparatively small value or importance, the plan worked well; it was only in case valuable objects or interesting buildings turned up that trouble arose; for then the Greek Government would have to buy or expropriate, and this was often inconvenient. I believe I am right in saying that, in more than one case, peasants are still claiming money for objects found by foreign schools years ago, which are now in the National Museum at Athens.

At the beginning of 1897 it was decided that the Government should no longer be subjected to this annoyance, and the General Ephor promulgated a new law of excavations; henceforward all those who designed to excavate on private property must first *buy*, and then excavate, the land at their own cost; then hand over all objects found; and finally hand over the land itself, to the Greek Government. This law, as will be seen at once, is a model of simplicity; and since it is not burdened with any cumbersome arrangement for the forced valuation and sale of likely sites, the fortunate excavator is provided by it with a capital opportunity of acquiring a first-hand experience of Greek notions of the price of land. Now it is not likely that the average peasant proprietor is going to be turned out of his homestead for its mere money value; and when it is remembered that the fact of your wishing to excavate his field confirms him in the conviction that gold statues are lying thick within it, it is not difficult to perceive that his notions of its value become extensive and peculiar.

The basis of this rule was the convention made between the French and Greek Governments in the case of Delphi; by virtue of which the excavators bought out the house-owners of Kastri at a Kastriote

valuation, and are to hand everything (even the houses the French have themselves built) to the Greek Government at the close of the work. But there are two considerations which naturally present themselves here; in the first place, the excavation of Delphi was a prize eagerly competed for by more than one foreign nationality, and, as a site for excavation, had a certain commercial value from the Greek point of view; in the second place, it had this distinctive feature, that the desirable area could be exactly localised within circumscribed limits of space; these conditions apply to scarcely any other site in Greece; and, therefore, to attempt to apply the Delphi convention to excavation generally, as Mr. Cavvadias did in 1897, would eventually have the effect of stopping all foreign scientific excavation in Greece. Such an intention may or may not be the policy of the Ephor General; if it be so, one can only deplore the injury that must inevitably ensue to science, and of which everyone who has travelled in Greece is perfectly aware. The antiquities of Greece are being excavated now, and will continue to be excavated, by illicit and unscientific native practitioners, out of whose hands they usually pass into those of the dealers; no record—or what is equally bad, a false record—is kept of the circumstances of their discovery; and a large discount is taken off their value by rough handling; so that it should be a matter for general congratulation (even to the Greek authorities themselves) if, under such conditions, a lucky chance brings a percentage of them at length into a museum, whether Greek or Barbarian.

As one instance, among many, of the inefficiency of the present system, the most recent excavation in Greece is a striking case in point: during the present spring (1898), the Austrian school has been engaged on the site of the temple of Artemis Lousatis, in Arcadia, a site which, under ordinary conditions, should have yielded a rich harvest of results; as it turns out, the site has proved comparatively unproductive, having been absolutely ransacked within the past three years for the benefit of the antiquity dealers. If a little more stringency were exercised towards these gentry, and a little less towards the foreign schools, it would be a gain for science, and certainly a great gain for the National Museum in Athens. I have good reason to know that this opinion is shared by most of those who are best qualified to know the facts in Athens. I have put the case as plainly as possible, in the hope that this mischievous regu-

lation may only endure for a time, and that a more generous policy may ultimately be restored.*

II.

Owing chiefly to adverse winds, the journey from Athens to Melos took us no less than a week, a short but somewhat trying Odyssey, which was not without its hardships; and lest readers of this paper should find themselves in like case, I will digress no further, but land them at once on Melos.

On April 12th, Mr. Mackenzie had preceded us for the purpose of making certain preliminary arrangements, and of concluding, if possible, a bargain with Cavallieri, the owner of the western half of the Phylakopi site. Owing partly to the intervention of one Nostrakis, a *δικο-ταλαίπυρος* fellow who professes law in the Melian community, the negotiations dragged on interminably; and when they were finally completed, Mr. Cavvadias found himself unable to provide us with an official supervisor, so that it was not, finally, until April 29th that the work was begun. Even then no official from Athens was forthcoming; but on our urgent representations, Mr. Cavvadias was at length induced to appoint as his *locum tenens* Mr. Timon Verges, the Scholarch of Melos; a gentleman who (let me say at once) in no way resembled either of his Shaksperian namesakes, and whose kindness and attention I am glad to publicly acknowledge. His place was afterwards taken by Mr. Grimanis, from Athens, from whom also we received every assistance and consideration.

On April 28th, Messrs. West, Edgar, and Crowfoot arrived in Melos, and were followed, on May 3rd, by Mr. Clark and myself. As Phylakopi could not provide sufficient occupation for so large a number of us, I determined to try and utilise some portion of our forces in other parts of the island. Here, however, we were confronted with the new ukase of the Government, permitting no digging in ground which we had not previously bought; and as, unfortunately, our funds were not sufficient for the purchase of the whole island, the prospect seemed at first far

* Since the above was written, I am glad to learn that, in Melos at any rate, the policy of the Government has already undergone a salutary change; after several months of fruitless negotiations between the British School and a refractory proprietor, the Ephor General at last decided not only to arbitrate, but to refund the sum paid (this year) by the British School for expropriation. This is indeed a welcome change of front: let us hope he may not weary of well-doing.

from encouraging ; without knowing what was in the ground, how could we decide what to buy, or the value of any given plot ? Under these circumstances, I appealed to the good sense of the local authorities, and was informed that tentative excavations (*δοκιμαστικὰ ἀνασκαφαί*) would be permitted for the purpose of facilitating a selection ; and a written authority was given me, stating that should any objects be found in the course of these tentative excavations, they should be declared in the ordinary way, and then remain the property of the landowners.

III.

On this understanding, Mr. Edgar proceeded with the workmen to Pelos, where he had reason to believe that primitive tombs had been found in a wheatfield, the property of one of our workmen, Manoli Prevenas. Manoli's field unluckily had a good crop of wheat ; but an adjoining field, which also looked promising sepulchrally, had no wheat to speak of, so we decided to try here while waiting for Manoli's harvesting. As the field in question belonged to his sister-in-law, Phlouri Ninos, we had the advantage of Manoli's good offices in conducting the negotiations.

A few days after, Mr. Crowfoot was similarly enabled to start an excavation in a field belonging to the Demarch (see *B. S. A.* ii., Plate I., immediately above the point marked X). The object of this was to determine the character of the ancient buildings which almost certainly must have lain immediately north of the Agora (see *ibid.* p. 81) and under the Acropolis. The Demarch most kindly gave us his permission, on condition of our paying compensation to the tenant, who had sown cotton in this field. Both these trial excavations were yielding promising results, when a fatal telegram from Athens brought them to an untimely end. A full account of each is given below on p. 31 and p. 35.

At the same time Mr. West undertook a third trial excavation on a plot of ground belonging to Photeinòs, one of our workmen, situated at a place called Petralonia, slightly to the east of Trypetè. It is in this neighbourhood that the tomb is still shown which, according to local tradition, yielded the large Gigantomachia vase now in the Louvre ; and it was in hopes of finding other tombs of the fifth century that we decided to test the site. Mr. West's report is as follows :—

“The ground is partly cultivated, but at the upper portion, at the top of the hill, is of hard rock, much overgrown with prickly scrub. Many tombs are apparent, consisting of deep rectangular sinkings, that have been opened and cleared of their contents; the covering slabs have disappeared, and the ground is overgrown with scrub, showing that the excavation took place long ago. Two of these were found to contain complete sets of bones, forming either one or two skeletons; but a careful sifting only brought to light one small coarse earthenware lamp, a couple of small fifth-century oinochoæ, a circular disk of bronze much corroded, and a portion of an iron finger-ring.

“One tomb only was found which had never been tampered with, near the base of the rocky hill-top, and partially overgrown. The surface-indication was a rectangular cutting in the natural rock. At a depth of one foot below the surface, the pick touched slabs of stone, four of which covered the tomb, resting on ledges at the sides. The interior measurements were 1·75 m. in length, and 0·45 m. in breadth; the skeleton was complete, but very brittle, and lay at a depth of only 1½ feet below the surface of the ground. Inside the tomb were placed three small lekythi, black glaze with bands left unpainted around the body—these were near the head of the skeleton; two small rough oinochoæ, a small terra-cotta lamp, and an alabaster pyxis supported on three feet.

“It seems not improbable that the cultivated ground of this proprietor may contain similar tombs.”

Mr. West's excavation had lasted only one day, when the closure* was peremptorily enforced; so that we were, after all, obliged to confine our attention strictly to Phylakopi; and the local searchers after truth (as I have since learned) have resumed their congenial occupation of nocturnal tomb-hunting.

IV.

Looking at the map of Melos on p. 72, one sees that the north coast, taken as a whole, forms one large bay of irregular outline,

* The telegram was as follows:—*Οὐδεμία ἀπολύτως ἀνασκαφή ἐπιτρέπεται ἐν ἰδιωτικαῖς κτήμασι πλὴν ἐν τῷ κτήματι τῆς Σοφίας Γ. Καβαλλιέρου τῆς διὰ συμβολαίου παρατιθείσης ὑπὲρ τοῦ κρατοῦς ἐπὶ παντὸς δικαιώματος ἐπὶ τῶν εὐρεθέντων ἀρχαίων:* (signed) Καββαδίας. The Draconian simplicity of this rendered misunderstanding impossible.

extending from the "cave" promontory (Κάβο της Σπηλαιᾶς) forming the northern boundary of the true harbour of Melos, to a headland which is the north-easternmost point of the island. This headland consists of a fine basaltic bluff descending sheer into the sea, which, doubtless from its sombre brown tone of colour, is appropriately called "the Monk" (Καλόγερος). This is the termination of a line of hills which trend due southward, almost parallel with the coast, but curving slightly inland, leave a narrow strip of fairly flat country fit for cultivation. Along this runs the road which to-day forms the principal route towards Kimolos from almost every part of the island.

This level stretch is dominated on the north-east side by the village of Phylakopi, which lies on a slope of the hill south of the "Monk"; but at the opposite end the ground again rises in a gentle incline, until it attains an elevation of about 18 metres above the sea-level, whence it falls sheer into the sea. On this highest level, and on the sloping ground extending in a north-easterly direction from it, was built the prehistoric and Mycenæan city, which we have termed Phylakopi. Immediately behind it is a narrow, shallow depression in the hills, the sides of which are honeycombed with tombs; unfortunately all these had been rifled before our arrival, but the fragments of pottery lying around prove them to be of the Mycenæan and pre-Mycenæan periods.

On the western side of the ruins the ground falls steeply away for a little, and then rises in another gentle hillock which is apparently composed entirely of soft tufa, into which the sea has forced its way in a series of caves and galleries, which in two cases extend as far as a hundred yards inland. Here and there the roofing has fallen in, so that one comes suddenly upon a tremendous chasm in the rock, at the bottom of which, far below, lies the deep blue water, hardly stirred by the swell of the outside sea.* It was in this soft and easily-worked pumice that the prehistoric people of the district had their burial place. The tombs consisted merely of holes scooped out in an irregularly rect-

* For a description of these "natürliche Badebassins," see Ehrenburg, *Die Inselgruppe von Milos*, p. 70: there is no evidence, however, that the "Treppe" which he there mentions is ancient. One such creek, hard by the citadel, is so regular in form as to suggest, at first sight, artificial cutting: with its gradually sloping bottom of fine sand, and its ledged sides, nature seems to have designed it especially as a haven and careening-place for such boats as a primitive people would employ. It is possible that this or some similar creek may indeed have served the early folk of Phylakopi, seeing that there is no other suitable landing anywhere near. It served our purpose as an admirable "Badebassin" during our stay.

angular form, never large enough to contain a body at full length. Unfortunately they also had all been rifled long ago; and though we went carefully over the surface, we failed to find a single unopened example. Judging, however, from the form, they appear to have been of the usual pre-Mycenæan construction; here and there, among the débris left by former excavators, we picked up fragments of primitive hand-made pottery and some excellent examples of the local obsidian knives.

The site of the ancient town previously to our excavation presented comparatively little evidence of antiquity. Here and there a careful observer, examining the loose stones and scrub with which the surface was covered, might have noticed the traces of walls, indicated usually by the fact that the stones in some places ran in regular lines and angles: the most prominent feature consisted of a more or less conical mound at the east end, out of which appeared, on the south side, the face of a wall in polygonal masonry: the part covered by this mound is roughly represented in PLATE I. in the squares A 5 to C 5. At the north-east corner of C 5 a hole had been rudely dug at some previous time, out of which (as local tradition reported) an antiquity dealer of Athens had acquired a considerable supply of obsidian implements.*

These indications led us in 1896 to make a beginning on the conical mound at the western end; in the few days which then remained at our disposal, we succeeded in clearing the greater part of squares A 5, B 5, and C 5, and in ascertaining that the polygonal masonry belonged to a vast wall of fortification enclosing a complicated series of house walls: these appeared to represent at least two epochs of construction, the lower of which, as the fragments of primitive pottery and the obsidian implements proved, antedated the Mycenæan period.

These results were sufficiently interesting to make it clear that the site was one which would be well worth excavating completely. That this is a work of considerable magnitude will be seen by a glance at PLATE II. *b*: this shows a plan of the whole area over which remains of the ancient town can be traced, representing a space, broadly speaking, of 200 metres by 80 metres, or about 16,000 square metres in all.

* On the surface of the eastern slope a boy of Rhylakopi had picked up two fragments of a fine cup in striated alabaster, which were bought by us and are now in the Museum of the School at Athens.

It must be admitted that as yet we have found no traces of ancient buildings outside the presumed limits of the wall of fortification; and we must therefore conclude, for the present at least, that the entire town, "basse ville" as well as Acropolis, was included within this circumference: such a plan seems to have been followed, for instance, in the case of Tiryns, the area of which is, if anything, rather smaller than that of Phylakopi.* Such a comparison in itself speaks volumes for the magnitude of our undertaking.

It will be seen from the plan that the wall of fortification from its western angle (in A 5) runs in a direction nearly due north, and terminates, or is broken off, abruptly at the edge of the cliff; and the general appearance of the house walls, which in some cases end abruptly at the cliff face, and almost everywhere are taken too near the present edge for practical purposes, also suggests that the city must have originally extended further to the north-west, and that this portion of it has, in the course of ages, gradually been destroyed by the inroads of the sea on the cliff. Considering that the cliff is here exposed to the full force of the north-west wind, bringing the heaviest seas with it, this is only natural. The peculiar line which the erosion has followed is due partly to this prevailing wind, but also probably to the existence of the softer bed of pumice already alluded to on the west side, which enabled the sea to turn, as it were, the western flank of the citadel. Evidence of this erosion is not wanting in the beach below, which shallows outward for some distance, and is broken with masses of rock which must owe their existence here to some such process as I have described.

What proportion of the town is now missing, from this cause, it is impossible at this stage to decide; possibly later discoveries may furnish some clue; so far, however, as we can judge from a comparison with analogous examples, there is only too much reason to suppose that the missing portion will prove to be that which was the most important; the highest level, if the town formerly extended seaward, would probably have occupied the squares represented by C 2 and 3; this would have formed the natural centre of the citadel, and it is here that the palace, if palace there were, must have been found.

* Cf. the table of comparative areas of the four Acropoleis of Mycenæ, Athens, Tiryns, and Troy, arranged by Belger in *Phil. Wochenschr.*, 1891, p. 1155.

V.

Turning now to the excavations of 1897, at Phylakopi, I ought to remind the reader that, as the excavation is still proceeding (in 1898), this paper must not be considered as, in any sense, a final report; that must obviously be held over until the work is completed. I propose to give here merely an *ad interim* record of the more important results obtained in 1897, and to put forward in a preliminary form the plans and sections of last season's work, drawn up by Mr. C. R. Clark. The account which follows is based partly on my own notes, but largely on the report of Mr. Duncan Mackenzie, under whose immediate supervision the excavation was carried on from beginning to end.

In a previous paper I remarked that, after the Mycenæan period, this corner of Melos seems to have been depopulated, and the centre of Melian life removed to Trypetè, which lies at the other side of the island. Ever since the Dorian immigration, these conditions have probably undergone very little change; and the houses of Phylakopi to-day can be counted on the fingers of one hand. The chief citizen is a patriarch, who, with his wife and a flourishing family of children and cattle, inhabit two caves, at the entrance of which the elders sit night and morning, counting their herds in and out in true Homeric fashion. The basaltic system is here, as on the West coast of Scotland, peculiarly favourable to the formation of caves, which play a considerable part in the political economy of Phylakopi; and our 70 or 80 workmen, who almost all marched over each Monday morning from their homes at Trypetè or Klimatobouni, returning thither on Saturday evening, enjoyed during the week such accommodation as was provided by Elijah for the persecuted prophets of Holy Writ. Fortunately for us, there are two real houses in Phylakopi, both of which were, by the courtesy and friendliness of their owners, put at our disposal. It happens that the Demarch of Melos and Mr. Tetarakis, the Deputy for the island, have each built a house here to serve as a retreat *en villegiatura* for the hot months, and we owe it to these gentlemen that we were enabled to pass the Phylakopi campaign in comparative luxury.

The site of the ancient town at present belongs to two landowners,

the boundary between whose properties is marked in the Plan (Plate I.) by the dotted line on the right, running north and south. Owing to the difficulties aforesaid, we succeeded in coming to an agreement only with the proprietor of the left, or western part; a great deal of time and trouble spent in importuning a widow, who possesses the eastern half, was absolutely thrown away; to all the claims of patriotism and science she opposed a placid but exasperating negative. It is necessary to explain this in order to show that our space was somewhat limited in extent, and that we were, therefore, only able to employ about half the number of workmen which we should have employed had the larger area been available.

Our first object was to complete the clearing of the outer side of the strong south wall of fortification, which had been excavated in 1896 to a depth of about 2 m. Before the excavation had been very long in progress, a feature presented itself which is, so far as I know, unexampled among the remains of primitive fortification which were hitherto known to us. Immediately outside the strong wall, and running parallel to it, at a distance of about 3 to 4 m., is a kind of breastwork of earth strengthened with from one to three courses of stones; here and there it is broken away, but sufficient remains to make it clearly traceable all along. At the south-west corner of the building it turns northward, at the same angle as the wall. At one point (almost at the junction of D 5 and E 5) this breastwork is connected with the strong wall by a small cross wall, near the lowest level of the foundations. From the upper surface of the breastwork the ground appears to have sloped outwards, giving the impression of a kind of glacis.

Plate II., *a*, gives two sections, in which Mr. Clark has broadly indicated the comparative levels. The upper section (a line taken east to west on the open letters A B of Plate I.) is adapted so as to show the bed-rock at the bottom of the trench between the wall and breastwork. The lower section (taken north and south on the open letters C D of Plate I.) shows clearly the relation of the breastwork or glacis to the wall of fortification, and the general difference of level between the exterior and interior of the town at this point.

As to the intention of this breastwork, I am unable to suggest any satisfactory explanation. That it was not intended to cover a passageway is obvious, from the existence of the cross wall, and also from the

uneven character of its bed, which, like the foundations of the strong walls, follows the broken surface of the rock. It seems certainly to have been deliberately designed at the same time as the wall itself; but it can hardly have served any useful purpose of defence, as it rises in many parts to a height of more than 3 m.

It may possibly have served a constructive purpose to the builders of the wall. Owing to the character of the ground, it is clear that the levels of the original settlement in A 5 to C 5 must have been considerably lower inside than they were outside the wall. Now, it is obvious that a wall of stones, loosely bound together with mud, and resting direct on the bed-rock, as these walls do, is not calculated to resist a pressure of undrained earth, exercised for some metres of its height on one side only. When, therefore, the ground in A 5 to C 5 was excavated by the original settlers to one general level for their houses, the town wall would probably not be set actually against the side of the cutting; a narrow space would be left, and the sides of the cutting might even be strengthened with courses of stones and with an occasional cross wall to keep them from falling in; afterwards this cutting would be filled in with loose earth and rubbish up to the level of the top of the cutting; this system would admit of the better manipulation of the exterior of the wall, and the loose character of the filling would probably constitute a less danger to the construction. Possibly some further light may be thrown on the question by the excavation of the squares E 5 and F 5; at present it remains a problem which awaits solution.

In the loose earth filling in the space between this breastwork and the wall, a quantity of fragments of primitive pottery and other objects were discovered. Among these were fragments of two rudely-fashioned mortars (?), and a pestle or corn-pounder in black stone (at a depth of 2 m.); part of a marble vessel, consisting of a slab hollowed out in the form of a thick dish (at 3.50 m. depth); part of a leaden vessel,* with incised lines marking the rim (from the left of the cross wall already referred to). Near the natural rock, forming the bed of the trench, among the fragments of pottery, were several pieces of stucco, which had evidently been attached to the wall or flooring of a

* The occurrence of this metal in a primitive stratum is important, as its employment in this period has been questioned. See *post*, p. 50.

house; these had usually on the smooth face a coating of red or pale yellow colour; but some fragments had apparently linear patterns in blue or black on a greyish ground.

It would seem that these objects represent the rubbish of an earlier settlement, thrown in from time to time, as the strong wall rose. If this earlier settlement were destroyed by fire (as indeed most primitive towns probably have been) this would account for the fact that at several points near the bed-rock in the trench, and afterwards in the town itself, we came across a stratum of burnt wood and ashes; at one point, at least (A 5, 15) this charred stratum appeared to run below the foundations of the strong wall, but this could not be definitely ascertained. The character of the pottery usually found in this lowest stratum, being almost invariably pre-Mycenæan, would seem to bear out this view; and it derives further probability from the arrangement of the town (see Plate I.). It will be noticed that the general mass of the house walls seem to be orientated with reference to the wall of fortification; but below the buildings so arranged we found, at several points (see *e.g.* B 5, 5), the remains of walls which ran under the house walls of the fortified town, and, in some cases, apparently even under the strong wall itself, and which, in any case, were constructed without reference to that wall. The wall of fortification, at its greatest height from foundation to present summit, measures very nearly 8 m. Its thickness is somewhat difficult to define, as, throughout its whole length apparently, it is honeycombed with rectangular chambers contained within its thickness, which is, therefore, varying: as a general average, it ranges from 5 to 6 m.; but at the bastion, in D 5, 6, there is a thickness of something like 16 m.

In the construction of the wall, at least two periods can apparently be traced: the earlier period is represented by a masonry which is looser in character, and is composed of smaller blocks of stone bound together with mud: this is preserved, in A 5, to a height of about 2.50 m., where it recedes, forming a ledge which is fairly horizontal, but of rough surface, about half a metre wide. Upon this wall is built the wall of what we may call the third period (the first period being assumed to be previous to the lower part of the wall): this is a Cyclopean construction of huge irregular blocks, brought up to a smooth face, with the interstices filled in with small boulders. Considerable

skill is shown in the adjustment of the blocks, but there is no trace of a disposition in horizontal courses. As will be seen by the plan on Plate I., this wall is stepped at regular intervals in the method which is already familiar to us from Mycenæan forts, such as Troy and Arne;* and wherever this happens, the projecting angle is carefully finished with a vertical course of larger blocks.

As usual, it seems to be a principle of the construction, both in the house architecture and in the strong wall of Phylakopi, to strengthen in this way the points where most lateral pressure is exercised; thus, for the parastades of the doorways and windows, and for the set-back of the strong wall, a column, as it were, of larger blocks always terminates the construction. At the south-west angle of the strong wall, where this lateral pressure would be heaviest, enormous blocks have been employed, some of which measure as much as 1.50 m. \times 1 m.

In the left-hand part of B 5, the outline of the strong wall takes, on its outer face, the form of a nearly rectangular projection, protruding from the general face along a distance of about 7.50 m.; the construction shows that this projection was not part of the original design, but a later addition, as the masonry of the main wall continues uninterrupted behind the lower part of it; the main wall had originally a set-back, the line of which has determined the right face of the projection which is in the same line with it. The later origin of this addition is further proved by the fact that its foundations are at a considerably higher level than those of the main wall, and below them are layers of charred wood, blackened fragments of pottery, and pieces of painted stucco. The general character of the masonry, however, resembles that of the higher level of the wall, or third town.

The chambers within the thickness of the strong wall are a puzzling feature; at first sight one is inclined to compare them with the system of chambers of this kind at Tiryns; but in the case of those near the south-west angle (A 5, 5-8), we failed to find any lateral communication of the chambers either with each other or the outside. The question can scarcely, however, be considered as decided, because the walls of these chambers were in so crumbling a condition that not only was it often hard to distinguish construction from débris, but at

* See the comparative table of such walls given by Noack in *Ath. Mitt.*, 1894 (xix), p. 428.

the deeper levels excavation became dangerous as well as difficult. We were, however, able to ascertain that in the lower part of A 5, 5-6 an older system had apparently existed, and had been altered at the time when the upper wall was erected. In B and C these chambers lengthen out and seem to form part of a system of rooms, that in C having a length of 14 m. by 2.50 m. wide; this has itself been separated by partitions into four, and may possibly have communicated with another system of about the same size, which partly overlaps it, extending further east (C 6, D 7). Perhaps these chambers were intended to serve for the storage and hoarding of grain and similar commodities, in which case we may compare, *e.g.*, the magazines at Goulas* figured by Mr. Arthur Evans in *B. S. A.* ii, p. 179, Fig. 5.

The block of buildings in D 5 and 6 is an elaborate system which presents some difficulties of explanation; one thing seems certain, that it formed a kind of bastion covering a passage and stairway, by which access was obtained to the battlements from the interior of the town. The stairway, of which fourteen steps are almost perfectly preserved, seems to have run from the top of the wall down into the heart of the bastion in an easterly direction, parallel to the outside wall-face; the steps consist of fairly rectangular blocks of stone, offering a riser and tread of about 0.26 m. each.† These stones are not bonded into the wall on either side, but are of independent construction.

They terminate at the bottom in a small square space, out of which a doorway opens at right angles to the stairway, communicating with a tunnel which runs north through the strong wall. This doorway (see Plate II., *a*, upper section) has the usual parastades built up of heavier stones, and has evidently been provided with a lintel of wood; the spaces on either side, into which the beam was set, can still be traced, but in course of time the wood has decayed, and the heavy stones which it supported have dropped out of place; in doing so, however, they have wedged, so that the original form is sufficiently plain. It measures about 2.40 m. in height by 1.70 m. in width. After

* For these "salles en contrebas," cf. also De Ridder in *Bull. Corr. Hell.* xviii (1894) p. 81, note 5.

† Cf. the tower at Troy measuring 18 m. by 9 m., which had within it the well and a door with staircase leading to it (*Ath. Mitth.* 1894, p. 390): also a stairway of the same period at Goulas, in Crete (*Mon. Ant.* 1895, p. 262, fig. 72), but this is hewn out of the rock.

passing through the wall for a distance of 3 m., where a similar doorway was discovered, which had apparently also had a lintel of wood, the tunnel continues as an open passage of the same width for another 4 m., and then widens out into a courtyard D 5, 1, of about 3.50 m. wide. At this point the labour of excavation was extremely arduous, the bed-rock here lying lower than at any other part within Cavallieri's half of the town; the ground on the margin of squares D 4-5, and E 4-5, is extremely deep and hard, and filled with debris of buildings; consequently we had not time to proceed very far with its clearing.

The excavation of last year within the walls naturally falls into three principal divisions or regions; (i.) the completion of the part begun in the first season, comprising the squares A 5 to C 5; this we cleared during 1897, practically down to the bed-rock; (ii.) the low level squares D 5 to E 5 just alluded to; and (iii.) the squares D 2-4 and E 3-4 (in the high-lying northern space), which were begun somewhat late, and where our excavation went down to very little depth.

The Region referred to as (i.), both in its general appearance and also in the character of the objects found there, gave the impression of being an inferior part of the town. The buildings, as a rule, are of fair size, but a connected plan is difficult to reconstruct out of the remains before us. C 5, 1 (measuring 6.50 m. \times 5 m.) appears to be an important chamber, with three doorways, two of which open, oddly enough, upon the narrow passage or corridor between it and the strong wall. A more than usually substantial wall (1 m. wide) appears in A 5, separating on each side of it a pair of large connected chambers (1-2 and 3-4), and out of room 2 a doorway on the east side leads into a courtyard (?) of irregular form (B 5, 1), of which two paving stones were found *in situ* (marked *a* and *b* on the plan); the differing levels of these stones seem to point to the floor having been stepped. But in all this maze of buildings we failed to distinguish any indication of roadway or even of separation between the houses.

Below the buildings of the more recent—or as we may call it—Mycenaean stratum, the traces were clear in this quarter of lines of walls of the more primitive town; these have usually been indicated in the provisional plan in outline only; they are, as a rule, of more careful construction than the later buildings, many of the stones being squared, and seem

to have been faced with a layer of plaster. Many of these squared stones were found in the débris at the bottom of the trench outside the strong wall, where they had probably been thrown after the destruction of the first town, and while the wall was in building.

In room A 5, 4, the lowest level was found to have had a flooring, slightly above the bed-rock, of a coarse plaster, similar to that covering the earlier walls; a good specimen of these earlier walls runs obliquely into the strong wall on the south side of this room, starting from a point in B 5, where it has a doorway, with two steps leading up into a room with plastered floor, which must lie under the strong wall itself; a section of this doorway, with the different levels, is given in the lower section of Plate II., *a*. The builders largely employed for these walls masses of burnt brick and squared blocks of poros stone; this whole room had filled up with at least a metre of earth before the massive wall of fortification was built over it.

Perhaps the most interesting feature in this quarter was the discovery of what seems to have been a factory of obsidian implements; the small room marked as B 5, 3, was found, at its lower levels, to be thickly covered with a layer of these implements, with lumps of obsidian in the rough, and the cores from which flakes had been chipped. Unfortunately, some previous excavator (an antiquity dealer of Athens, we were told) had hit upon the same discovery, and had quarried away a good deal here with an utter disregard of walls, which have consequently been destroyed at this point.

It would appear as if the block of buildings in Region i. had been divided off from the rest of the town; such at least seems to be the intention of an important wall which skirts the west side of C 5, 11, and runs due north until it is lost in the edge of the cliff; in this wall, which rests direct upon the bed-rock, no trace of any door or break of any kind was found; at the edge of the cliff, and in a line with it, is a huge stone, faced exactly like those on the outer face of the strong wall, and which appears to have been built into it.

In Region ii., as has been stated, a great depth of earth was encountered, and we could do little more than elucidate the plan of the strong wall in this quarter. Wherever we did go down, we found that the purely Mycenaean pottery continued to show itself down to at least a depth of 3.50 m. In the last days of the excavation some work-

men were set to clear the surface ground along the eastern boundary of Cavallieri's ground, and it was then found that this whole region seems to be bounded on this side by a wall which runs in an indented line, due north, as far as the beginning of Region iii. Whether this presumed division of the town into quarters is more than a presumption, can hardly be decided until the results of another year's excavations are to hand.

In Region iii., the highest part of the site, the chief characteristic is the shallow depth at which Mycenæan rooms are found, the floors of which are, in some cases, not more than half a metre from the surface. The entire upper part of D 3 (and probably of E 3) is occupied, at this depth, with a network of rooms, which are all orientated as the rooms in (i.), but out of which, as before, no definite house-plan can at present be constructed. Lying, as these rooms do, so near the surface, their walls are, as a rule, preserved only to the height of a few courses, and the evidence of communication and connection may very easily have been for this reason lost. The most noticeable feature of the region is the occurrence of a long wide roadway (?) which divides the block of buildings just described, from the southern part of the same region. It runs in a slightly curving line, almost due east and west, and from its width and position seems designed to be one of the main streets of the town. Like some of the chambers adjoining it (D 3, 11, and 16), it is paved throughout with slabs of a smooth bluish-grey stone of irregular outline, but carefully laid. Similar paving is already known in constructions of the Mycenæan period, at Goulas (*Mon. Ant.*, 1895, p. 213, fig. 44) and elsewhere.*

At the east end this passage presented some difficulty, for although the wall bounding it on the south side could be traced continuously as far as our border went, we failed to trace it—the northern wall—further east than the eastern wall of the room D 3, 16, where, so far as our excavations went, it came to an abrupt end.

At one point in this passage (marked on the plan beside D 3, 12), some slabs of the paving were found to be missing, and we took the opportunity of sinking a shaft at this spot; below the level of the pavement, the earth was excavated to a depth of nearly three m.,

* Also at Mycenæ, see Tsountas, *Μυκηναίαι*, p. 37: and at Gha (Armé), De Ridder in *B.C.H.* xviii. (1894), p. 285.

and from the paving slabs downwards, everything that was found proved to be pre-Mycenæan. At the point where the north wall ends (beside the south-east angle of D 3, 16), the pavement had also been destroyed, and here again we were able to excavate further down; this partially solved the difficulty, for a wall was discovered immediately below the level of the pavement running parallel to the south wall, but of much better construction; this wall extended to a depth of 3 m., and evidently belonged to the earlier construction. At this point, therefore, we have an important test for the separation of two of the town levels. It would seem that this roadway of the Mycenæan town follows the lines of a similar roadway which had existed in the town preceding it.

Outside the wall of fortification the ground rises in the squares A 6, B 6, in the form of a gentle hillock, which falls again towards the road (see Plate II., *b*). This hillock is of the hard conglomerate, covered with a loose scrub growing in a few inches of soil. In order to make sure that no traces of ancient buildings or burial remained here, I had the entire surface tested, with the result of a discovery that at first seemed to promise well. Immediately opposite the late bastion in B 5, and at a distance of about 20 m. from it, we found that the rock had been cut away so as to form a rectangular pit, 2.50 m. wide and 16 m. long, in a direction due south, that is, away from the walls and towards the centre of the hillock. The suggestion of a dromos leading possibly to a subterranean tomb-chamber was not altogether unwarranted, but unhappily proved delusive. Having with considerable labour cleared the entire passage, we found absolutely no outlet to it.

After the surface earth was removed, the pick struck upon a layer of extremely hard soil, about half a metre thick, as the workmen said, *γρεμνὸ, ὅπως εἶναι φυσικό*. Then suddenly the soil became soft, and was found to be full of fragments of pottery, all of the pre-Mycenæan period excepting three or four small pieces. At the upper edge the pit is 3 m. wide, tapering about 30 cm. down to a width of about 2.50 m., at which width the sides continue perpendicularly downwards, carefully smoothed, until a depth of 2.60 m. is reached; here the rock is carefully cut to form a level bottom. At the south end (see Plate II., *b*), the passage widens out into a rectangular chamber about 4 m. square, to the same depth as the passage.

What was the object of this curious excavation? The fragments of pottery filling it were in such quantities and so much broken that it seemed as if the filling in had been taken from some Monte Testaccio of the primitive town; that it had primarily some less ignoble intention, is clear from the character of the work: the rock in which it is cut is extremely hard, and the cutting has been effected with an almost mathematical regularity. It seems difficult to imagine any purpose which such a work could have served except a sepulchral one. It will be remembered that in the valley to the south of this point are the remains of the Mycenæan tombs. I think we are justified in supposing that what we opened was the dromos intended to lead into a tomb under the hillock; but that the tomb, unluckily for us, was for some reason never completed.

VI.

Turning now to the actual objects found at Phylakopi, I propose here only to give a brief indication of some of the more important, pending the fuller publication which must await the termination of the work on this site. Of pottery, either whole vases or fragments, we collected an enormous hoard, each fragment of which is marked with a reference to the spot and depth at which it was found. A close examination of this, which must needs be a lengthy and laborious task, cannot fail to throw valuable light on the history of the earliest stages of pottery and of art in Greece. The site, as might be supposed, is particularly rich in the fabrics of pottery usually regarded as pre-Mycenæan; of the typical "island ware," which, at the neighbouring site of Pelos, is the only fabric yet found (see *post*, p. 35), curiously enough only two fragments came from the excavations of the first two seasons at Phylakopi; these were found at a depth of 2.50 m. below the Mycenæan pavement in D 3, 12. Otherwise all the principal classes of primitive pottery are well represented. Even the curious pottery of Kamárais in Crete,* to which no parallel has hitherto been found in the Greek Islands, seems to have had an interesting congener here. A large fragment of a jug was found by us of greyish yellow ware,

* See the publications by J. L. Myres in *Proceedings Soc. Ant.* 2nd S., vol. xv., Pl. i—iv.; and by Mariani in *Mon. Ant.* vi., p. 333, Pl. 9.

decorated with a design in an unvarnished grey-black; this consisted of a band of floral patterns and spirals below a band in which is an extremely primitive representation of a human figure, with circular head, and hands with extended fingers held up on each side, very rudely rendered. This figure, and the decoration generally, suggest comparison with the Kamárais fragment, *Mon. Ant.* vi., Pl. 9, Fig. 10. It is perhaps worth noting that the large spirals which form such a marked feature in the "Melian" vase paintings of historic times were already in this remote period a favourite element of decoration at Melos. A form of which we found several examples entire is that of an open bowl with flattening for foot, recurved lip, a rude spout, and pinched-out handle. The peculiar feature of this class is that while the lower part is hand polished to a fine red, a band on the upper part is coloured white, on which the decoration—usually linear patterns—is laid in greyish-black. This class must represent an early stage of the introduction of paint, in substitution, on the one hand for the patterns until then incised in the clay, and on the other for the rope and other raised patterns which are also largely found here.

Though the "Pelos" vases were scantily represented, we nevertheless found plenty of other objects which must be referred to that civilisation; such are the head of one and the figure of another (wanting only the head), of the marble "idols" of the usual type; the half of a fine vase in black stone (steatite?) of a usual form of island vase (see *post*, p. 57, Fig. 4), grooved vertically; a very similar one is figured in Evans's *Cretan Pictographs*, p. 123, Fig. 123; and a whole series of stone objects and implements, saddle querns, corn-rubbers, hammers, &c., and a four-legged stool of exactly the form used by the seated harpists from Thera, figured in Blinkenberg-Beauvois, *Ant. Prémyc.*, p. 18, Fig. 5.

Of architectural remains, other than those already mentioned, very little was found; everything went to show that the later Mycenæan settlement, lying as it does nearest the surface, has undergone, in the part we excavated, the most thorough destruction, and that the wood, which must have formed an important feature in the preceding periods, had mostly perished in a conflagration. To this category, however, may be referred a few objects of interest: (i.) The drum of a column in poros stone, of rough style, was found in D 3, 12, below the pavement,

about half a metre down; it tapers slightly from a rough base, and when found showed clear traces of red colour: (ii.) Fragments of a finely-worked marble pavement, smoothed and polished on one surface, which were found in an inverted position at C 5, 6, at a depth of 3 m.; in the same spot, at this level, were a large number of the usual little coarse terra-cotta saucers, with bones of animals, charcoal, and fragments of red stucco wall-facing: (iii.) Some fragments, apparently architectural, of a curious variegated sandstone; one fairly large piece is worked up to a fine smooth surface and shows the edge of a return, as if it had formed part of the angle of a doorway or window. I submitted a small specimen of this stone to Dr. Woodward, of the Natural History Museum, who kindly informs me that it has been identified by Mr. G. T. Prior, of the Mineralogical Department, as porcellanite. A specimen in the Museum was found at Chalakas* (the district on the opposite side of the bay of Melos, see the map on p. 72); it is extremely hard, but its warm and brilliant colouring must have commended it to the architects of this colour-loving people.

To an early stage of the Mycenæan period belong a series of terra-cotta idols, in the usual primitive types of female figures, with the drapery indicated by stripes of reddish-black; one of these has the arms raised beneath the drapery; another, wanting the head, has this unusual feature, that the arms, with the fingers spread, are indicated in thin lines of black paint across the breast. This fact may be of importance in its bearing on the question as to how far the details of form in the marble idols were supplied by colours now lost. Among this series was found an arm in terra-cotta, 0.85 m. long, completely modelled in the round, encircled with a series of bands of black colour; the fingers appear to have held some object; this has been detached from a statuette, which must have been very much larger in scale than is usually the case in terra-cottas of this type.

In the room C 5, 1, at a depth of 2 m. from the surface, was found a terra-cotta boat, of the ordinary Mycenæan fabric, of which two views are here given.

The surface is covered with a creamy-white wash, on which the details are indicated in black glaze-colour; only small fragments from

* Probably by Dr. Philippson. It does not appear to be mentioned in Ehrenburg's chapter on the "Petrographie" of Melos (*op. cit.* p. 98).

the lower part of the stern are broken away. It has been modelled by hand, and the interior has been hollowed out with some fine-pointed tool; length 1.27 m.; height at beam 0.18 m.; width at beam 0.47 m.

This model, rough though it is, presents some features which appear to be of interest in the history of early Ægean navigation. First, it is noticeable that already at this early period there are found on each side of the prow the painted eyes which formed a constant feature in all subsequent Hellenic shipping. If this may be accepted as the earliest representation of a boat that has yet come down to us from a Greek

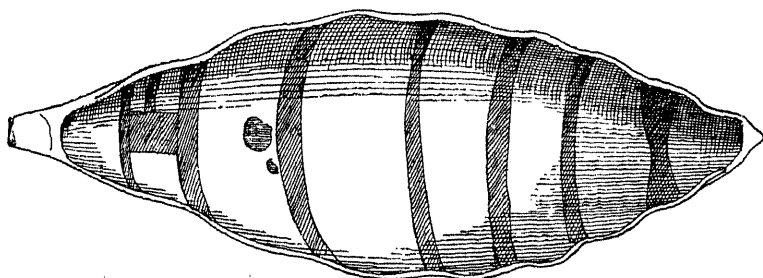

FIG. 1.—TERRA-COTTA BOAT FROM PHYLAKOPI. Interior view.

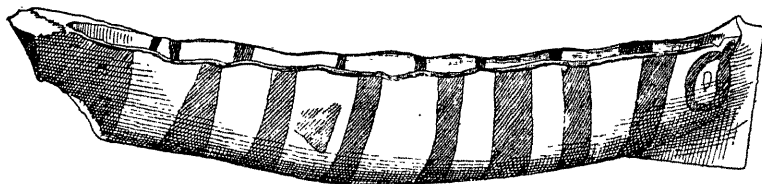

FIG. 2.—Side-view of Fig. 1.

site, it seems to confirm the view of Cecil Torr (*Anc. Ships*, p. 69), that the original intention of the eyes, on Greek ships, at any rate, was that the ship might see her way, and that it was only later that they became hawse-holes.

The most natural explanation of the black lines is, that they represent the ribs, presumably of wood: it is true that in the terra-cotta models of boats from Naqada* there are shown similar bands running vertically around the boat; but in one case at any rate these run longitudinally as well. It is evident, however, from the form of the boats

* Petrie, *Naqada*, Pl. xxxvi; De Morgan, *Tombeau préh. de Neg.* p. 90, Figs. 235—7.

that they are made of reeds, and these marks clearly indicate the fastenings, which unite the bundles of reeds to one another. The Phylakopi boat is wholly different in form and construction. In examining the interior view (Fig. 1) it will be seen that the outline of the gunwale is wavy, and forms a series of concave curves between the ribs. The reason of this is, I think, to be sought in the method of construction of the original of our model.

Primitive civilisation all the world over knows two, or at the most three, forms of boat: in a well-wooded country the most natural form is in wood, the hollowed-out tree, or dug-out: in a woodless river-valley like Egypt, and in a lake-country like Switzerland, the material most to hand is reeds or withes. But for a sea like the Ægean, where a smooth surface, though frequent, is not always to be relied upon, some more seaworthy system becomes essential. If we may judge from the conditions of the present day, the Cyclades have never been well-wooded, nor possessed of large trees suitable for the construction of sea-going dug-outs; it is therefore *a priori* probable that the primitive navigators of these islands adopted the third rudimentary species of boat, composed of skins or hides stretched over a framework of wood. The Welsh coracle has a primitive American cousin in the "bull-boat" mentioned by Catlin* as used by the Indian women on the Missouri and its tributaries, and which is made by stretching the hide of a buffalo bull over a crate made of poles (the *Κάνναβος* of Greek antiquity). The kayak of the Eskimo, which is similarly constructed, is capable of conveying men in the stormy Arctic Seas far greater distances than separate most of the Cyclades from one another: and boats of this kind may well have sufficed for the limited needs of the pre-Mycenæan population of Phylakopi.

That this mode of construction was known in antiquity is clear from various passages in ancient literature. Pliny, in discussing the use of *σπάρτα* in *Iliad* ii., 135, refers* to a time "cum sutiles fierent naves, lino tamen non sparto unquam sutas." Strabo (308) speaks of *πλοῖα ῥαπτὰ*; and that the tradition was known to Vergil is shown in *Aen.* v., 414:—

"gemuit sub pondere cymba
Sutilis et multam accepit rimosa paludem."

* See Otis Mason, *Origins of Invention*, p. 363, Fig. 72.

† *H.N.* xxiv. 4c.

If then our boat be admitted as a primitive *πλοῖον*, its peculiar characteristics are at once explained. The black lines are the wooden ribs, over which the hide is stretched; but as their lines would be clearly traceable under the tightly stretched skin, the painter shows them on the exterior as well as on the interior. The gunwale line is formed probably by a cord attached to the upper ends of the ribs; and the wavy outline shown in the model is due to the natural sagging of the hide inwards and downwards between the ribs. An objection to this explanation is the absence of any indication of a keel; we should expect to find a black line running both on exterior and interior along the bottom of the boat from stem to stern. It may be that the artist has unintentionally omitted this detail. Perhaps, in the difficulty of procuring timbers sufficiently large for this purpose, it is possible that some other device may have been adopted for keeping the ribs in position. This could conceivably be effected by fastening short cross-pieces from rib to rib; between the first and second rib from the stern end there is in fact one such cross-piece which seems to be further strengthened by a narrow half-rib running up to the port gunwale. In the coracle,* which is keelless, the timbers are kept in position by wattles, and some such plan may have been adopted for the Phylakopi boat.

From the appearance of the colour on the stern it would appear as if this end of the boat was made in one piece of wood; perhaps the indication of the cross-pieces at the stern end only is intended to suggest this fact. A slight additional weight at the stern would be rather an advantage than otherwise, but it is clear that some lighter mode of construction would have to be adopted for the bows. It would seem from Fig. 2, that this difficulty is surmounted by the addition of two pieces of wood fastened to each other at right angles, or possibly a thin slab of wood presenting a rectangular edge to the front of the bows; the end of the lower piece is attached to the base of the foremost rib; this, when covered by the skin, would form a very respectable cutwater; and the sagging of the skin behind the cutwater would give to the counter just the lines shown in Fig. 2, which curiously enough are almost exactly those of a modern dinghey, though absolutely unlike any example of a classical boat which has hitherto come down to us.

Of objects in bronze there was naturally no great store, as the pro-

* Cf. Pliny, *H.N.* vii, 57, 15; xxxiv, 156. The design figured in Tsountas and Manatt, p. 333, fig. 158, is not a boat, but a floral pattern.

lific strata of Phylakopi certainly belong to a very early stage of the Bronze Period. In D 2, 1, at a depth of about half a metre, a bronze vase with handles was found; unfortunately it was touched by a workman's pick before discovery, and being very thin and corroded, it fell to pieces; at E 4, 6, at a metre from the surface, many fragments of a bronze bowl with turned rim; and at C 5, 9, half a metre from the surface, an arrow-head of bronze; this has only one barb, but in its corroded state it is difficult to say whether this was the original form, or whether the second barb has been broken away.

VII.

As a striking contrast to these comparatively insignificant bronze items, it is rather curious that by far the most important object discovered by us should be in bronze. This is the statuette represented on Plate III.* It was found between two stones in the east wall of C 5, 7, at about half a metre from the surface. It is cast, so far as one can tell, solid, and, unfortunately, the lower part has in consequence suffered a good deal from corrosion, including the left hand, the size of which appears greatly exaggerated, owing to the swelling of the metal: the most important portion, however, including the head and body down to the waist, is happily preserved in almost its original state. When found, it was in three pieces, but these have been easily joined, and nothing important is wanting.

The sex of the figure cannot be determined with certainty, but the modelling of the torso, which, both from its condition and careful modelling can be relied upon for this question, seem to suggest that the figure is male; the prominent breasts and hips, which even in the primitive marble idols characterise the female sex, are not here accentuated at all; and it clearly has not the crinoline-like skirt usually affected by the Mycenæan lady.† On the other hand, though the forms

* This publication is only preliminary: it is intended to give a more adequate reproduction at an early date.

† On this point Blinkenberg remarks (*op. cit.* p. 54) that, the faces of male and female being in the marble idols rendered exactly alike, it is probable that the men were clean shaved. The argument is not convincing, especially when we reflect that the hair of the head is not marked (or at least not now visible) on any known example: and that much may have been done to indicate these details by colour. If the men of this race wished to shave, doubtless (as Blinkenberg says) the obsidian knives would suffice. In one of the Pelos tombs (see *post*, p. 41) Mr. Edgar found an obsidian flake cut, apparently by design, into a semicircular form, which may represent a razor.

are those of a full-grown person, there is no indication of hair on the face, nor yet of the belt (*μίτρα**) or loin-cloth.

While, therefore, it cannot apparently be classed with the known bronzes of the Mycenæan period, it obviously represents a very great advance on the level of art shown in the marble and terra-cotta idols. A striking feature is the almost exaggerated tendency to curved outlines shown here, as opposed to the stiff angular forms of the marble figures; as if the artist had been anxious to use to the full a newly found freedom of modelling; and it cannot be denied that, in spite of its rigidity, this little figure shows a spirit and study of nature which place it on a level apart from any object of the pre-Mycenæan age yet known to us.

That it is of Ægean origin and not imported from some other civilisation is, I think, beyond question; the stiffness of the joined legs, and the peculiar blocking out of the feet, are due to inherited tendencies. In the gradual evolution of the art of sculpturing the human figure, the arms free themselves long before the legs; obviously the necessity for setting a figure upright and for providing it with a solid support render the treatment of the legs a difficulty; and so it comes that in the early marble idols the problem of legs and feet is frankly left unsolved. Probably the preference for rendering draped figures (*e.g.*, in the Mycenæan terra-cottas) is due to the fact that drapery enables the artist to avoid the difficulty. In the marble idols, which are never draped, the legs are sometimes mere stumps, intended probably to be stuck into the ground; but with the increase of skill, the feet can no longer be omitted, and the stump for insertion into the ground, or pedestal, is attached beneath the feet, as in our bronze.†

The curious position of the feet in the primitive idol, set at an obtuse angle to the legs, is well explained by Blinkenberg (*op. cit.* p. 16) as due to the working of the figure out of a flat slab of marble; it is obvious, that as the due projection of the feet cannot in these circumstances be rendered, their proportion can only be preserved by, as it were, bending them downwards. To this limitation many of the peculiarities of technique in these figures can be traced. If this be so, the word *σάνις*, as applied to the primitive statue, has a new significance.

* Perdrizet in *B.C.H.* xxi., p. 169.

† Cf. *Arch. Anzeiger*, 1892, p. 48, No. 62.

The gesture of the arms, again, in our figure is traceable to the same origin; I cannot agree with the theory* that the idols with hands on breasts are necessarily imitations of foreign models, and connected with Asiatic divinities. The gesture in question has no connection with the Asiatic suggestion of fertility, but represents a stage in a perfectly natural technical evolution. The most primitive type of rendering the arms is that of pinching out a formless knob from the shoulders, a type which is more natural in clay than in marble, and which, therefore, occurs rarely in the marble idols.† From here to the carving of arms in the round is a long interval, which is filled by many stages of gradual transition. Two alternatives offer: either to let the arms hang along the sides, as usually in Egyptian art (this involves a difficulty in the case of female figures where the prominence of the hips prevents the arms from following the sides closely): or to fold them across the body; for this, which is by far the most usual method,‡ at first a series of parallel lines engraved on the surface suffices; then modifications are introduced; the upper arms are separated from the sides, and the forearms are no longer parallel to each other, but one hand is raised to the breast;§ and, finally, the forearms also are freed, and the first position they naturally take results from the stage preceding, and is shown in our bronze.|| There is no example, so far as I know, of a pre-Mycenæan idol with a hand on each breast such as would be the case if the Asiatic origin is to be accepted, although that position of the hands was always within the capacity of the primitive artist.

The long neck, and the curious formation of the cranium, are also characteristic of the marble idols. In working a figure out of a flat slab, the tendency to elongation of proportion appears a natural consequence; and it may even be that there is a feeling of compensation in length for necessary limitation in depth.¶ To a similar practical cause is probably due also the setting back of the head in an oblique direction: if the face were kept vertical, it would have to be cut upon

* *E.g.* Blinkenberg, p. 12.

† See, however, *J.H.S.* v., p. 50, Figs. 3-4.

‡ *J.H.S.* v., p. 50., Figs. 5, 7, 8.

§ One such, unpublished, is in the British Museum.

|| Cf. *Arch. Anzeiger*, 1892, p. 48, No. 62.

¶ The attenuated type of figure seems to have lasted a long time in Melos. The Apollo published in *B.C.H.* 1892, Pl. xvi, is a striking instance. I hope shortly to publish other early Melian sculptures in which the same characteristic occurs.

the surface of the slab and it would be impossible to give the nose in relief; the setting back of the head not only permits the construction of a nose, but allows of more room for the due projection of the chin. It is noticeable that this tilting back of the head is characteristic of most primitive sculpture in all ages, and must be due to some practical reason. Possibly the form of nose in our bronze, with its exaggerated base, is also a reminiscence of the triangular knob which does duty for a nose in the marble idols.

If, then, we admit the direct descent of our figure from the island idols, the curious form of cranium is only what we should naturally expect. The disproportionate height of the occiput in relation to its depth and width can hardly be explained as an accurate rendering of a race-type on the unsupported testimony of our bronze. In Mr. Edgar's excavation at Pelos (see *post*, p. 40), several skulls were found of a pre-Mycenæan race, but unfortunately they crumbled away on exposure to the air. Bent, however, in his excavation at Antiparos, was successful in preserving one skull from a grave of this period, which is reported upon by Dr. Garson in *J. H. S. v.*, p. 58. From his account it would appear that the skull is abnormally dolichocephalic,* though not to the same extent as our bronze. Possibly the type of head which, in the marble idols, had originated in a technical necessity, grew into a conventionality of the sculptor's art; but it may have excited less remark among contemporaries whose skulls were, by nature, much higher than ours.

It must be admitted that in every respect there is a considerable gap between the most advanced of the marble idols hitherto published and our bronze. This gap will be appreciably lessened by the publication which Mr. Bosanquet will shortly give of a marble head from Amorgos in the Ashmolean Museum, and of which he has very kindly sent me photographs. This head gives us exactly what we need to show the intermediate stage; it clearly belongs to the class of primitive marble idols, but is modelled with a good deal of observation, completely

* It is curious that the same dolichocephalism has been remarked in skulls of the Stone Age from Egypt, as well as other characteristics which recall the "island" type. "En effet, bien que les autres signes ne concordent pas, l'abaissement du plan du trou occipital, la forme du nez, ne peuvent manquer de donner l'idée qu'il s'agit d'un échantillon de la race noire"; but there is other evidence showing this to be impossible (De Morgan, *Recherches ; L'Age de pierre*, appendix on the skulls of El 'Amrah, p. 269).

in the round. The artist has evidently met with the same technical difficulties and conventionalities as we have seen in the bronze, but has faced them less successfully—possibly handicapped somewhat by his material.

In this head we have the same exaggeration of details, such as nose and ears, due perhaps to the difficulty of working marble into delicate detail with primitive tools; the same protruding lips, which, together with the form of nose, suggest at first sight a negroid type, but may also be due to this technical cause; and the same absence of that prognathism, which in a negroid type would be essential. The eye is indicated by a slight prominence of exaggerated size, on which the true outline of the lids is deeply engraved; the succeeding stage would appear to be that of completely hollowing the cavity, a plan which has been adopted in the bronze. In the proportions of the cranium again, there is a marked exaggeration of the height, a line taken from the tip of the chin to the crown, as compared with a transverse line measured at the base of the hair, showing a proportion of three to two. In our bronze this proportion appears immensely exaggerated; but this appearance is partly caused by the swelling of the metal in corrosion, which also prevents us from seeing what method (if any) was adopted for indicating the hair. In the Amorgos head, the hair is indicated by deeply scored lines radiating from the crown, upon a slightly raised surface.

Taken altogether, I think we may say that the Amorgos-head and the Phylakopi bronze offer valuable evidence for bridging over the interval hitherto existing between the island idols and the art of the Mycenæan period, and are, in default of better examples, important monuments for the earliest history of Greek sculpture.

CECIL SMITH.

REPORT OF TENTATIVE EXCAVATIONS ON THE DEMARCH'S FIELD, MELOS.

THESE excavations began on Thursday, 13th May, in the afternoon: on Thursday, Friday, and Saturday, seven men were engaged upon them, but on Monday five more were employed. On Tuesday, at mid-day, they were brought to an abrupt close by a peremptory telegram from the General Ephor in Athens, forbidding all tentative excavation in Melos.

This field was partially excavated last year by Mr. Bosanquet, and the results of his work are described in the *Annual* for 1895-6: it was hoped that excavations continued this year under easier conditions would throw fresh light upon the system of walls connected with the city gate, and any public buildings which might have been situated there. The proprietor very courteously gave us the required permission, and the government representative in Melos approved of our proposals.

With the view of working in the direction of the last year's tunnels, I started a broad trench in the middle of the field, and was fortunate in striking upon two walls, at the depth of 15 cm., on the first afternoon. During the following days I was occupied exclusively in tracing out the course of these walls, and the result of this work will best be seen by reference to the subjoined *plan*.

The wall which I have marked *a* ran for 3.54 m. from N. to S., ending at the S. end in a piece of very late and bad construction, which united it with another at right angles: this cross-wall too was, so far as I could judge, also of late work, pieces of brick being built into it in some places. Finding this late masonry, I did not think it necessary to continue work in this quarter: it is possible that the wall at right

angles with α is of the same period. At the other end the wall α ended in a small cross-wall perpendicular to β , and forming a slightly obtuse angle with α . In the space between these walls were traces of what I believe to be the supports for steps: my reasons for this conclusion are as follows:—The cross-wall only extends down for 60 cm., below which was found the natural earth: the bottom of wall α is 1.32 m. from the top; wall β , which alone has a sound foundation, is 1.56 m. in height. Between α and β are rests at irregular intervals

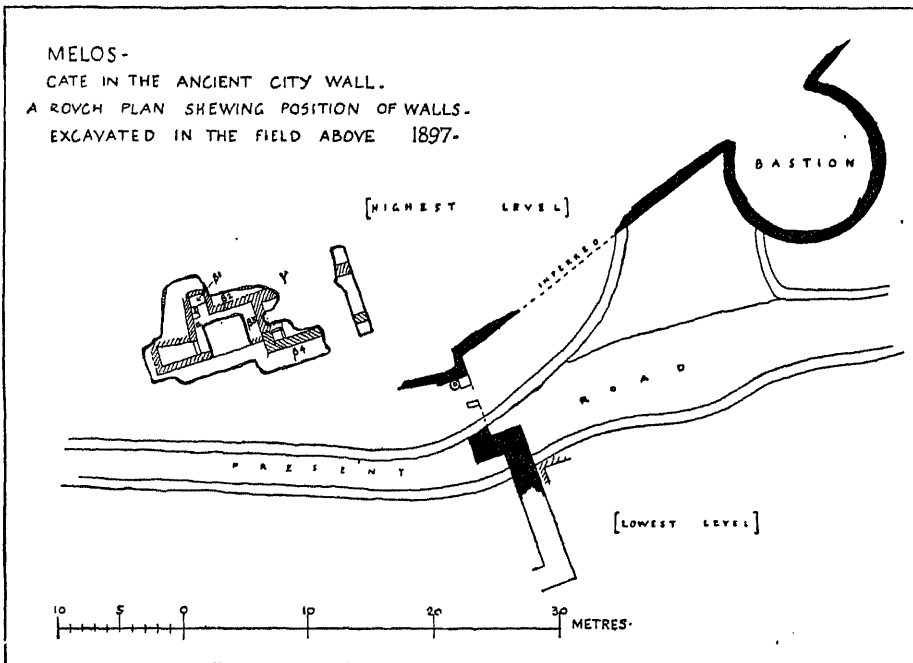

PLAN OF EXCAVATION IN THE DEMARCH'S FIELD, MELOS.

(m. .60, .98, 1.12, 1.32), which would serve very well as the supports of a small flight of steps. The corners, too, between α , β , and the cross-wall are inside corners only (α ends flush with the *inside* of the cross-wall), and all three walls, though carefully faced on one side, are quite rough upon the other: therefore, I suppose them to be only supporting walls of an upper terrace or system of buildings, with a small flight of steps leading up between them from a level not much above the bottom of wall α (1.32 m. from surface).

The wall β continues perpendicular to the cross-wall for 1.75 m., then it turns and continues at right angles in the direction of the gate for 3.54 m. At this point it turns again (see *plan*) and continues for 4.30 m. Here it was very much broken, and I had great difficulty in tracing it: at last I found the right line and followed it for about 5 m., only in one place digging down to the foundations, which were here 2.40 m. deep. The masonry was decidedly better, and the work was made more difficult by the number of large stones which had fallen, evidently from the wall. Having traced the wall thus far, I tried to economise labour by beginning another trench about 2 m. distant from the point already reached, and running N. and S. Here I found the wall continuing as I had expected, and further N. a wall of the same character running parallel with it at a distance of about 3.60 m. In order to determine whether this wall joined β , I made a small trench at the point where they ought to cut one another, and found that they were connected, but that this new wall was considerably broader than β .

At this point the excavations were prematurely closed by reason of the telegram mentioned above.

The masonry of the walls a , β , γ , is of much the same character: it is properly faced on one side only with blocks of local trachyte. These are often quite thin slabs, 14 cm. or so only in depth, and the solid appearance which they give the wall is, therefore, somewhat fictitious: as a rule, however, the depth of the blocks is not the same, they are much deeper at one end than the other, and so would remain firmly fixed in the wall. The blocks are much larger and squarer, as might be expected, in the lower courses of the walls, especially in those nearest the gate. Behind this facing of trachyte, the walls a , β^1 , β^2 are quite roughly finished at a depth varying from .45 to .65 m. β^4 and γ appear to be more carefully faced upon both sides. This style of masonry is not uncommon in Melos: the temple foundations below the smaller Akropolis are of similar character, though here concrete is largely used, while in the walls which I have been excavating I have found no traces of any kind of plaster. This fact seems to point to the Hellenistic period. The walls β^4 and γ are not exactly parallel to the wall leading from the city gate discovered last year, and therefore we cannot say for certain how far they were connected: they may have

formed part of a complicated system of gate fortification, and to this the style of masonry, with its facing, would point; or they may have belonged to a separate building—not domestic, for the masonry is too substantial—and to this hypothesis their rectangular plan lends some probability. But as this is a question which a few days' excavation could easily settle, and which nothing else can, further conjecture seems superfluous.

In the corner formed by β^3 and β^4 , a curious square construction was found: two walls about 1·80 m. below the surface formed, with the two walls above, a small square, of which the inner side measured ·72 m.; from this point downwards for ·60 m., the sides and floor of the square were cemented, so as to be capable of containing water (there was no hole in the bottom). The wall parallel to β^4 continued 1·10 m. above this tank, the other wall ended where the cement work began. Obviously this tank—if so it may be described—is too small for a water cistern: one of the workmen said that a similar construction is now sometimes used for wine, but whatever it was, it appeared to be later than the system of walls round it.*

The cross-wall δ appeared to belong also to a later system, but I did not excavate it sufficiently to enable me to speak confidently upon its character.

Fragments of glass, Samian ware, broken pieces of wine jars, and some very late Roman pottery were found—nothing certainly Greek.

Also a Doric capital, some column drums, and a moulded (monument) base or cornice, all of soft stone, and several thin fragments of marble.

J. W. CROWFOOT.

* Inside this tank the soil was of a different character from that turned up elsewhere: it was yellow in colour, with fragments of red and white chalk; the yellow soil was soft, and might have been used as fuller's earth.

PRE-HISTORIC TOMBS AT PELOS.

I. *The Site*.—The late Dr. Dümmler was struck, on his visit to Melos, by the difference between the pre-Mycenæan tombs at Phylakopi and those that he had just seen opened in Amorgos. Still another, a third variety, had been reported from Syros. Not that the discrepancy disturbed his view of the pre-Mycenæan question. What the want of uniformity proved, to his mind, was merely that uniformity was not to have been expected.*

It is, however, becoming more and more evident that at one period one particular type of entombment, the Amorgan type, prevailed all over the Cyclades. Pappadopoulo's account of the Syran graves is not to be taken any more seriously than his account of their contents. The tomb dug out and described by Mr. Bosanquet (*Br. School Ann.*, ii., p. 188) may be regarded as the ordinary kind in the early cemetery of Syros; though somewhat different in construction, it is of the usual island form. There may have been later tombs of later types in the neighbourhood, but that is another question. In Melos again even the earliest of the rock-hewn tombs at Phylakopi, whether or not they are the work of a different race, are markedly younger than the cist-cemeteries. Although these tombs were thoroughly plundered long ago, still, from the fragments of pottery that lie strewn around so many of them, especially those that were reopened a few years ago by the local professional, it is possible to get some idea of the culture of their occupants. To put aside the rude cups and bowls (*Ath. Mitth.* xi., p. 16, Beilage, 2, B.), which are no exact criterion of age †—

* *Ath. Mitth.*, xi., 35. "Ein lehrreiches Beispiel, wie vorsichtig man mit Schlüssen aus der blossen baulichen Anlage auf die Epoche der Gräber sein muss."

† As already noted by Blinkenberg in a very useful summary of the question, *Antiquités prémycénienes*, trad. par E. Beauvois (*Mém. de la Soc. royale des Antiquaires du Nord*,

at Phylakopi we found them by the score in the company of Mycenæan, even late Mycenæan ware—the characteristic pottery of the graves is painted pottery. If there is a striking difference in the mode of burial, there is quite as striking a difference in the contents of the tombs. The tombs of Melos prove no more than those of Syros that the same early race in the same age buried their dead in different ways in the different islands. In the *pre-Theran* period, as in Syros and Amorgos, so in Melos the islanders buried their dead in cist-tombs.

For within the last two years evidence has been unearthed of an earlier settlement on Melos than that described by Dr. Dümmler. The district of Pelos (Πηλός) lies south of Phylakopi, about an hour's walk. One crosses the upland, past the church and monastery of Hagioi Anargyroi, the Penniless Saints, and descends upon a wide marshy plain in the centre of which appear the domes of Palaiachora, the deserted capital. On the hill-slope, a little below the line where ploughed land begins, a peasant lately came upon a tomb of the early Ægean type. It was a likely inference, which Manoli did not fail to draw, that a whole cemetery lay underground. None of the tombs that were subsequently opened (with one doubtful exception) had ever been investigated before, although many of them had been damaged; so that the discovery was a new one entirely.

Mr. Mackenzie visited Pelos in the summer of 1896 and remarks on it in his paper upon the ancient sites of Melos (see *post*, p. 73). One question that he discusses is where the settlement which supplied the cemetery was likely to be situated. He saw no trace of a pre-historic habitation in the neighbourhood, nor did I. It need not be assumed that the islanders of this very early period dwelt within strong walls

Nouvelle Série, 1896), see p. 35. He shows without difficulty that Dümmler had no real evidence for regarding as contemporary, and indeed identical, the two cultures, that of the cist-tomb period and that of the Theran type. Further, while the cups from the Amorgan tomb are made by hand, the cups found at Phylakopi with pottery of the Theran and Mycenaean types are all wheel-made.

I am, of course, expressing no prejudice as regards the more important question whether the culture of the type exemplified by the rock-tombs at Phylakopi is a continuation of the old island culture or the innovation of a new people. It will be seen in Mr. Bosanquet's article, p. 53, that pottery of the primitive type representing an advanced stage of development has been found in graves at Phylakopi—to say nothing here of the only partly excavated fortress. And it will be remembered that Dümmler mentions an earlier type of tomb there, "flache Erdgräber," constructed, according to tradition, more or less incompletely with slabs of stone; no specimen now remains. Possibly this may be only a development of the primitive type (which, indeed, can be perceived to have been increasing in size as time went on), and a transition to the coffin-like tombs cut in the soft rock.

like those of Phylakopi or Goulas in Crete. Even the earliest traces of residence at Phylakopi seem to belong to a distinctly later age than the Pelos graves, though it may be too soon to say so positively. And it is a significant fact that though many cemeteries of cist-tombs have been discovered on the islands, yet in no instance have clear signs been remarked of an adjacent settlement.* So it seems a likely conclusion that the primitive communities that introduced the cist-tomb into the Cyclades were not in the habit of building strongholds on high ground, but lived in more perishable homes on humbler sites. The home of the Pelians at any rate was looked for in vain.

A theory has been started that in these early times the islanders, or a portion of them, were pile-dwellers. Tsountas, arguing that one branch of the Mycenæan stock was originally a pile-dwelling people, derives some of his evidence from the Cyclades. Foremost comes the often-described vase from Melos, a stone pyxis which is supposed to be a copy, in miniature, of a pile hut. From this and a few other data of no importance,† he concludes that "the island-folk were no strangers to the pile-dwelling, but this rather goes to show that they were colonists from the mainland,"‡ *i.e.*, an early "Mycenæan" contingent. But the latter of these two conclusions is even less defensible than the former. If the hut-vase from Melos indicates that once on a time some of the islanders lived in pile-huts, it would naturally be the people that made the vase that were the pile-dwellers. Now Dümmler showed long ago (*Ath. Mitth.*, xi., p. 446), that it was the handiwork of native Ægeans and of no "Mycenæan" immigrants, however early. There is a similar stone pyxis from Amorgos (*id. Beilage*, I., A. 4), in the Berlin Antiquarium. It by the way is also pronounced to be a copy of a pile-hut. Now the objects found along with this latter pyxis were typically Ægean, what Tsountas calls

* It would be a satisfaction if a theory could be verified that Bent held with regard to the earlier cemetery on Antiparos, the one that more closely than any other corresponds with ours at Pelos. Like many of the others, it lay on the slope of a hill overlooking the sea, and in the shallow water of the bay beneath, which Bent supposes to be a comparatively recent addition to the Ægean, he was able to make out a few traces of ancient dwellings. "A clever fisherman," he says, "who knows every inch of the bay, told me that pottery, similar to that I found in the graves, was very plentiful at the bottom of the sea near the houses." *J. H. S.*, v., 47, 48.

† Supposed traces of a conical roof in one of the pre-historic chambers on Thera; remains on Amorgos of a circular building of the seventh century B.C.

‡ Tsountas and Manatt, *The Mycenæan Age*, p. 327.

“Carian,” and the tombs in which they were found were of the typical island form. And nobody argues that either the spiral, with which those two vases are ornamented, or the art of making stone vessels was an innovation from the Greek mainland. So that the Melian pyxis is beyond dispute a piece of pure native work.

Thus if there is any evidence at all that there were once pile-dwellers in the Cyclades, the natural conclusion would be that “the islanders who reared their conical huts on piles” were the primitive islanders, the “Carians.” Further, we know to some extent in what manner of houses the supposed “Mycenæan” or “proto-Mycenæan” immigrants lived, *e.g.*, at Thera and Phylakopi. This immigration from the mainland is itself an unproved assumption, which this is not the place to discuss.

But after all there is no evidence worth calling such that there were ever pile-dwellers in the Cyclades. One need not dwell on the unsuitableness of the land. It will appear later on that the form of the Amorgan pyxis is nothing but a natural development of a very early island type. That is the simple explanation of the “conical roof.” In short the Amorgan pyxis is not a copy of a pile-hut at all, and the resemblance of the Melian pyxis to a pile-hut has been pressed to absurdity. Thus the “thatching” over the doorway, like the “thatching” round the top of the Amorgan vase* is simply an early island pattern, Fig. 1.

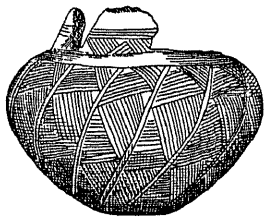

FIG. 1.

All about the cemetery at Pelos the soil was thickly sown with pottery of many periods. Among the objects nearest in age to the contents of the tombs and found deepest down I may mention first a rude terra-cotta weight with a pinched-in top through which a hole is pierced (fig. 9), and secondly a vase-lid with a knob, wheel-made, of a dull black earthenware, 5 cm. in diameter. There were fragments of late Mycenæan pottery and of several kinds down to fifth-century Attic. Evidently Pelos had long continued to be a centre of some sort,

* The same “thatching” may be seen round the top of a primitive vase of the *duck form*, from Melos, in the Museum of Sèvres. Nor is the cross on the base of the Amorgan vase a unique ornament in the Ægean; it occurs quite frequently, in paint, on the bases of native vases from Phylakopi, *cf.* Evans, *Cret. Pict.* p. 114, fig. 106b.

whether of habitation or of worship. A little way above the cemetery are traces of the regular lines of some large building. On the last afternoon that we were destined to spend at Pelos, we set to work to examine it more closely. The outside wall appeared to have been built of large squared blocks. About a metre and a-half below the top of one of those blocks we arrived at a schist pavement, among the fragments of which lay a small Greek vase of the fifth century B.C., and the remains of a great amphora. But just at this point the Ephor General of Antiquities at Athens ordered work upon this site to cease; and I have therefore no further information and no opinion to offer as to the nature and age of those ruins.

II. *The Graves.*—A thorough examination of the necropolis at Pelos was to have formed part of the British School's work in Melos during last season. It was very desirable that the unrecorded pillage, such as befell the cemetery at Siphnos—and, indeed, no one knows how many more in the various islands—should cease. About the middle of May I went over to Pelos from our head-quarters at Phylakopi with a few workmen, one of whom was the discoverer of the graves and the owner of most of the land under which they were hidden. This zealous antiquary, to judge by the collection of pottery that stood in his house (rather than by his varying and too modest recollections), must have emptied about ten tombs in the preceding year. In the few days' time during which we were left at liberty to pursue our work we came upon nine others. These twenty or so tombs lay all together in a cluster; whether this was the whole graveyard, or only an outlying group, a day or two more would have told; but in any case it is unlikely, if one considers how little variety there was among the twenty tombs opened, that further work would have disclosed any fresh feature.

The graves themselves were much like those that Bent opened in the earlier cemetery on Antiparos. Four erect slabs of poros-stone from the neighbouring hill-side formed a rude receptacle, 80 or 90 cm. in length, 50 or 60 cm. broad, and 50 cm. deep. The bottom was paved with thin plates of schist, what the people call ψαρόπλακα. A huge stone lid, roughly flattened on the under side, was set on the top.

Few of the tombs had all their parts complete. I found only two

cap-stones, and the previous investigator, so he declared, had encountered only one. But most of the lids and many of the side-slabs must have lain near enough the surface to disturb the progress of even a Greek plough: no doubt they have been weeded out from time to time; and, indeed, one or two, still whole, were to be seen in the surrounding stone dykes. The occasional incompleteness was, I have no doubt, the result of accident, and not due to an intentional economy like that observed in Antiparos and Amorgos (*J. H. S.*, v., 49; *Ath. Mitth.*, xi., 27).

The tombs were crammed tight with sticky mould, what Mr. Hogarth describes as "that unpleasant soapy earth which results from human decomposition." There was no trace of ashes. Burial, not burning, had been the practice. But like the other islanders, and like many primitive races, the Melians must have buried their dead in a very cramped posture. Several of the tombs had held at least half a dozen corpses. It will be remembered that in the "poorer" cemetery of Antiparos, the tombs as a rule contained more than one body, while in the richer and later cemetery each corpse had a tomb to itself. So crumbly and clogged with mould were the skulls that, though the utmost care was exercised, we did not succeed in fetching away a single one.

The head had in most cases been laid against the west wall. But neither in the position of the bodies nor the lie of the tombs was any principle of orientation apparent. The pots lay sometimes at one end of the tomb, sometimes at the opposite; and in no case were more than two found in one grave.

These general remarks are based not only on what I observed myself, but also on what was to be learned from the friendly proprietor, who had anticipated our researches. By way of supplement and illustration I subjoin a more exact description of some of the individual tombs.

Tomb 3.—Nothing remained of the structure of this tomb except the schist flooring, which lay about a foot below the surface of the soil. Two vases were found embedded close above the schist, Fig. 2, and a broken pyxis, $12\frac{1}{2}$ cm. broad, with polished black surface. Some peasant had evidently extracted the lid and the four walls, without suspecting that they enclosed a grave.

Tomb 4 was perfect, and measured 60 cm. by 45 cm., by 50 cm. deep.

The lid was not *in situ*, but lay about a yard off, sunk deep in the soil. Contents, one vase (Fig. 3), a bead of natronagalmatolith (Fig. 4), and a small crescent-shaped piece of obsidian.



FIG. 2.

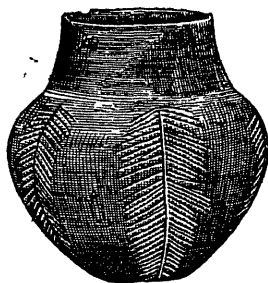

FIG. 3.



FIG. 4.

Tomb 5.—(For plan, see Fig. 5.)—The lid and one wall were missing. The longest side measured 90 cm. Three skulls lay in a line in the north-west corner, and there were traces of three more at the other end of the grave. No vases or other objects.

In this case and in others it is hard to believe that each corpse had some belonging or other buried with it. Blinkenberg remarks (p. 23) that in such cases we must assume the vessels laid in the grave to have been of wood or some other perishable material. Vessels of wood may have been in use or they may not. But I see no need to assume that the custom of burying vases, &c., with the dead, was universal in the earlier period of Ægean culture.

Tomb 6.—(For plan, see Fig. 6.)—This tomb was in perfect preservation. The sides measured respectively: 55, 55, 70, 80 cm. The depth

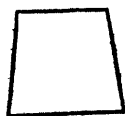

FIG. 7.



FIG. 6.

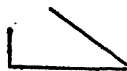

FIG. 5.

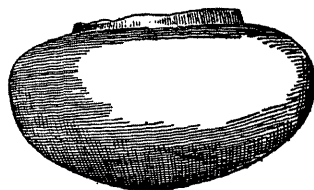

FIG. 8.

was 50 cm. To move the enormous cap-stone was all that three men could manage,—μέγα ἔργον, ὃ οὐ δύο γ' ἄνδρες φέροιεν. One skull lay

in the north-west corner. No vases. Nor was there anything *below* the floor (cf. *Ath. Mitth.*, xi., 18).

Tomb 7.—(For plan, see Fig. 7.)—The sides, which in this case were of schist, measured 80, 70, 80, 90 cm. The lid was gone. About 50 cm. down three skulls lay crushed into the north-west corner. At the same level we found three obsidian blades. Deeper down we came upon more remains, a vase (Fig. 8) and a skull close together in the north-east corner, and another vase, upside down, in the south-west corner, of the same red colour as its neighbour, and, like it, without the usual suspension-holes, but shaped like Fig. 3. There were also traces of two more skulls. This tomb did not appear to have the usual schist pavement. The evidence of repeated occupation was unmistakable.

Tomb 8 was in ruins. One upright wall and part of another was all that remained of it. A vase lay against the remaining wall, and a second stood close to where another wall had been; both were of the usual type (Figs. 1 and 3); one had a reddish surface, the other was black, and was covered from shoulder to base with a lightly incised pattern like herring-bone, but with this difference, that the short oblique lines ran all in one direction.

III. *The Find.*—The contents of the various tombs were characterised in the main by a monotonous uniformity. The full yield was thirty earthenware vases, more or less complete, and a few smaller articles. Nor was there much variety among the vases themselves. In short, the find has added nothing new, or next to nothing, to the list of pre-Mycenæan antiquities. But, on the other hand, the very uniformity of it has a value; for it discloses, with all the greater clearness, a distinct period in the long course of pre-Mycenæan culture.

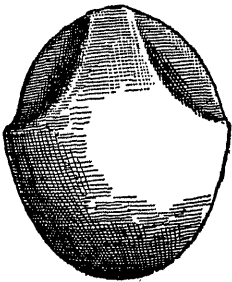

FIG. 9.

Out of the usual contents of the island tombs, objects of bronze and other metals, marble idols, obsidian blades, earthen and stone vases, we found no wrought metal at Pelos, and no marble figures. But the rude terra-cotta object (Fig. 9), which was found among the tombs, and which, indeed, may have come from a shattered tomb, deserves to be mentioned in this connection. It is most probably intended for a weight

(cf. Schliemann, *Ilios.*, p. 411). But the shape is peculiar,* and recalls a primitive type of idol (Evans, *Cret. Pict.*, p. 125, Fig. 126), which looks like an anticipation of the Mycenæan images, with arms upraised conventionally in the form of a crescent (cf. also Schliemann, *Ilios.*, p. 333, Fig. 202).

Obsidian was fairly plentiful, as indeed was to be expected in an island so rich in that material as Melos. I found it in three out of the nine graves (Nos. 1, 4, 7). In tombs 1 and 7 two or three of the usual rude blades, about 6 cm. in length, were lying close together, and may have formed part of one instrument.

I found, also, one small bead of green natronagalmatolith (Fig. 4), very like those from Dümmler's Tomb D in Amorgos. It measured 2.6 cm. by 1.4 cm. The fact that only one bead, and not the whole necklace, had been buried with its wearer, may indicate that such a necklace was a rare possession at this period.

The pottery from Pelos, on the other hand, is numerically the most considerable collection that has yet been brought from any pre-historic necropolis on the islands.† The class to which it belongs is already well known, through the researches of Bent in particular, and has been lately discussed by Blinkenberg. The vases are of course hand-made, and as a rule are moulded with great accuracy. Almost all of them are highly polished, and on several, Fig. 8 in particular, the faint scores of the polishing instrument are quite distinct. Their colours vary from a light red to black; and the hue of almost every vase varies in depth on its different sides, while the break is black in the centre and lighter as a rule towards the surface—the usual marks of uneven and imperfect baking.

About half of them have a plain polished surface, the others are covered from shoulder to base with a simple incised pattern, usually herring-bone, like *J. H. S.*, v., Fig. 10. Blinkenberg has a theory, which does not strike one as needed, that this system of decoration is a copy of the network with which he assumes the prototypes of our vases to have been covered and carried. In the case of the pyxides

* There is a weight of similar form, but much less rude, in the Acropolis Museum.

† The contents of the graves excavated by the British School are in the National Museum in Athens. The other vases were obtained from their discoverer, and form part of a small collection of antiquities in the British School.

and of one large vase like Fig. 14 (Br. School Register, No. 17), the herring-bone encircles the body in horizontal bands; and the neck of another vase (Fig. 11) is ornamented in the same manner.* Fig. 3 shows a less conventional application of the same device, an approach to the painted fern-leaf on the vases of the Theran period (Athens, Nat. Museum, 41). A closer resemblance of the same kind may be seen on a large kernos from Phylakopi, in the Museum of Sèvres, which has one of its cups painted with a herring-bone pattern, bounded at each side by two vertical lines, exactly in the style of some of the primitive incised pots (cf. *Br. Mus. Vase Cat.* i., A 89). Fig. 1 is the most elaborately finished vase in the collection. It is covered on the outside with a light-brown coat, on which is indented a triangular pattern, like *J. H. S.*, v., p. 56, Fig. 13—a common one, though not in this particular form, in the primitive art of many countries.

The various shapes of vases found at Pelos are all represented in the illustrations of this paper. More than half of the pots are of the same type as Figs. 10-12, the shapes varying between the refined form of Fig. 10, with its spreading shoulder and long neck, and the rounder body of Fig. 12. They stand, as a rule, about 13 cm. high

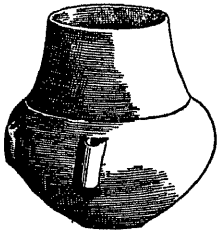

FIG. 10.



FIG. 11.

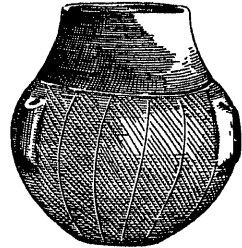

FIG. 12.

and measure about the same across. The base is remarkably small in proportion to the width at the shoulder; sometimes it is flat, sometimes hollowed out with a slight protuberance in the centre.† With one or

* Elide the horizontal lines and this pattern becomes a system of vertical zigzags, *e.g.*, on a vase from Melos, Sèvres Mus. 388c (see Brongniart and Riocreux, pl. xiii., 7).

† Blinkenberg (pp. 28, 29) has a passage that deserves to be quoted on this particular detail, the form of the base in hand-made vases:—"Tandis que le potier, se servant uniquement de la main, aimera mieux arrondir le dessous; pour le mettre à plomb, il lui donnera 3 pieds, ou retranchera une partie du dessous pour le rendre plat ou bien le renforcera. Mais le fond arrondi

two exceptions they are all provided with suspension-holes, a pair on each side (see Fig. 10), but not close together, as on some later vessels from Syros and Tiryns. On the vases of this type the holes are vertical

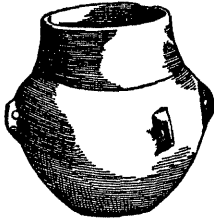

FIG. 13.

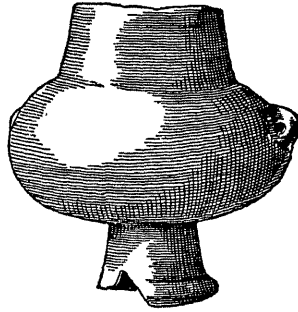

FIG. 14.

in every case but one (Fig. 13), a very heavy pot, which differs from the rest in one further respect, for it is unpolished (Register, No. 11). In Fig. 1 the holes are pierced down the walls of the vase instead of in the usual narrow projections.

The arrangement of the suspension-holes on the other types is more

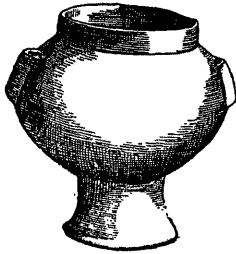

FIG. 15.

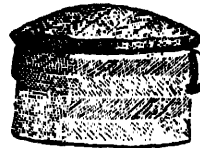

FIG. 16.

varied. In Fig. 14 they are horizontal, while Fig. 15 has but one vertical hole on each side. The pyxides also have one vertical suspension-hole on each side, which hole is continued through the lid (see Fig. 16).

est souvent conservé et il faut alors donner au vase un support particulier. A ce point de vue les vases d'argile des sépultures prémycéniques sont complètement primitifs; ordinairement ronds au fond [Oliaros A: 4 exempl.: Syros B]: plus rarement plats [Amorgos B: 3 ex.]: un seul des vases publiés [Amorgos B] a, si le dessin est exact, un pied particulièrement profilé." That may be the principle, but those are not the facts. The vases from Oliaros (*i.e.*, Antiparos) are none of them round-bottomed, nor is any pre-Mycenæan pot from the Cyclades that I know of.

Of the individual vases, one in particular is noteworthy, the oval saucer (Fig. 2), with a horizontal suspension-hole on one side—a new form in terra-cotta, so far as the Cyclades are concerned.

One of the things considered most characteristic of the primitive island culture is the stone vase. The history of the many types of Ægean stone vessels is a question of much interest, now especially that Mr. Arthur Evans has traced back some of the said types to early Egyptian art. The only object of the kind discovered at Pelos was a little dish of poros-stone, 3 cm. high, 9 long, and 6 to 7 broad, roughly hollowed out, and shaped like the crucibles which Schliemann excavated at Hissarlik (*Ilios.*, p. 409, Fig. 472). But though our find at Pelos has added nothing to the *material*, yet it has perhaps a certain bearing on the whole question which it may be worth while to state.

When stone and earthenware vessels of similar form occur in the same find, it is impossible to pronounce, *a priori*, in which of the two materials the form was first expressed. The vessels of stone that, as a class, have most in common with the early stone vases of the Ægean, are those discovered by Messrs Petrie and Quibell, at Ballas and Naqada. Along with these were found a number of earthenware vases of similar form, with an unmistakeable imitation, in paint, of a stone surface; which proves that the stone vessels were in this case the prototypes. There is no sign of direct connection, though there is a general resemblance between the stone vessels of the two races, the "New Race" and the islanders. But is there a parallel in this one respect? Were those Ægean types which appear both in stone and earthenware first of all expressed in stone?

The only way of getting the answer to this question is by comparing the contents of the various island cemeteries that up till now have been reported upon.* Only two, Pelos and Antiparos I. † (*i.e.*, the "poorer" necropolis) have yielded practically no stone vessels; all the

* I omit Ross's cemeteries (at Heracleia, &c.), about which our information is too scanty, and also the graves on Amorgos excavated by Tsountas; the latter find has not yet been published, see *Πρακτικά*, 1894, p. 22.

† It is unfortunate that an exact record has not been preserved of the two respective finds in Antiparos. However, it is pretty clear from the course of Bent's description (*J. H. S.*, v., pp. 49-52), that the very primitive idols were the only marble objects found in the first cemetery, and that the marble vases came from the second. And he adds (p. 53), "In the poorer graves we seldom found anything else but pottery; it is all of a rude character and frequently incised with rude patterns." Thus it is safe to assign to the first cemetery the bulk, if not the whole, of the pottery identical in form and manufacture with that of Pelos.

others, Antiparos II., Amorgos, Siphnos, Syros, and Arvi in Crete contained both stone and earthenware. Now the two former can be shown to belong to a more primitive age than the latter. Antiparos II. proves its advance in culture by its metal ornaments, by the better shape of its idols, by its larger and more elaborate graves. Amorgos also (I mean the necropolis at *Δωκαθίσματα*, described by Dümmler) is later; witness, among several other things, the variety in the contents of the tombs. Of Siphnos we know less, but a specimen tomb measured 1.40 cm. by 80 cm., by 60 cm. deep, and its idols* were evidently much beyond the Antiparos I. stage (*Ath. Mitth.*, xvi., 210). At Syros also the tombs are of a less primitive make (*Br. School Ann.*, ii., p. 188); and the earthenware vases in ornament and finish are far ahead of the Pelian. The "finer fabric" of the one terra-cotta vase from Arvi, published by Evans, and the rich furniture of the one tomb described by him (*Cret. Pict.*, p. 117), both point to a more advanced stage. So all the probability is that the stone vessels as a whole are later than, and, therefore, to a large extent evolved from, the earthenware vases of the Pelian types.

The most characteristic shape of vase at Pelos and Antiparos I. is that represented by Fig. 10, and this shape, so far as the Cyclades have yet been searched, has never been found in stone, and only in one instance, so far as our information goes, along with vases in marble.† It would seem then, though of course it remains far from certain, that this primitive type was going out of use about the time when marble began to rival clay as a material for vases. But the same type set on a stem (Fig. 14) is found, though it is much less common, both at Pelos and Antiparos, and lasted a long time in earthenware; there is an advanced specimen from Amorgos in the Athenian Museum (No. 49), and a vase from Aphidnae, published by Wide (*Ath. Mitth.*, xvi., Pl. XIV., 1), is certainly a late example of the same class. Translated into marble, this type became one of the most characteristic products of early Ægean art.‡ The inside, a cup-like hollow, often very small

* Besides the idols Pollak noted two small objects of transparent green stone which seemed to him to represent a phallos and a foot. Is it not more likely that they were nothing more than the heads of two idols? Cf., for the shape of head, Evans's *Cret. Pict.*, p. 126, Fig. 129. One of our workmen at Phylakopi who found a similar marble head pronounced it, like Pollak, to be a *ποδαράκι*.

† A miniature specimen in Siphnos (*Ath. Mitth.*, xvi., 210).

‡ Examples in Oxford, London, Vienna, Athens.

(cf. *Ath. Mitth.*, xi., Beil., i., 3), bears no relation to the exterior form, another proof that these marble vessels are imitations of pottery. One feature in particular ought to be noted, which several of them have in common with the Pelian pots, and that is the wide neck, shaped like a narrowing funnel. Of those that still retain this traditional characteristic, perhaps the best examples are two large vases of lychnites in the British Museum.* Between this early form and such a shape as is represented in *Ath. Mitth.*, xi., Beil., i., 5, the degradation is quite apparent.

The stone pyxis again has its earthenware prototype among the finds from Antiparos and Pelos; and the conical lid of the stone vase, which Tsountas believes to be copied from the roof of a pile-hut, is copied from nothing else than a conical lid of clay. (The example published, Fig. 16, has a much flatter lid than at least one other specimen from Pelos.)



FIG. 17.

Less characteristic and important, we find at Pelos in earthenware the same type of bowl (Fig. 17) as occurs later in marble (*e.g.*, *Ath. Mitth.*, xi., Beil. i., E. 1.) Even the oblong saucer (Fig. 2) has a marble descendant in the Ashmolean Museum.

The type of pot represented by Fig. 8, is much the same as the ordinary Pelian shape; only it is flatter and is intended to carry a lid. There is a similar vase in Berlin, with lid complete, from the necropolis near Syra, and further examples of the same type have been found on other later sites, Tiryns and Arvi, and, probably at least, Phylakopi (see p. 53). That it also passed into stone is proved by an instance from Tiryns (Athens Mus., No. 1673). There is a link between this type and one of those Cretan forms in which Evans sees a direct Egyptian influence (*Cret. Pict.*, p. 119, Fig. 117). An earthenware vase

* In the Egyptian collection. But there is no doubt that they are early Ægean work. Mr. Cecil Smith has kindly sent me the following conclusive information about them:—"They came to the Museum together in 1843 from the collection of the Earl of Belmore. The bulk of this collection consisted of Egyptian objects, and hence the presumption has been that they also were found in Egypt. But the Museum possesses the plates of a catalogue of the Belmore Collection, which gives outline views of most of the things; and I see that these two vases are there figured in one group apart, together with a series of about six vases, which are certainly Greek. It is therefore highly probable that the two lychnites vases were obtained by Lord Belmore in Greece." Cf. *post*, p. 65, and Murray, *Handbk. of Grk. Arch.*, p. 8.

from Antiparos (probably from the second cemetery, for it is not of the ordinary early ware) is almost identical in shape with the Cretan vessel; only it has a slight neck, somewhat like that of the pyxis (Fig. 16) to hold the lid fast (*Brit. Mus. Vase Cat.*, i., A.92). The sharpening of the curve at the shoulder that characterises this vase is not an uncommon development in primitive Ægean pottery. Compare two vases in Athens (Mycenæan Room, 1671, 3987). The same difference is apparent between the large vase from Pelos (Fig. 15) and the little and also later one from Phylakopi (p. 53, Fig. 1). Thus the Antiparos pot with its two pairs of vertical suspension-holes is a not unique development of an early island type.

NOTE.—The illustrations above given were drawn by Mr. F. Anderson, all except Figs. 4 and 9, from photographs by Mr. Cecil Smith, to whom I am indebted not only for this, but also for constant information and assistance in other ways.

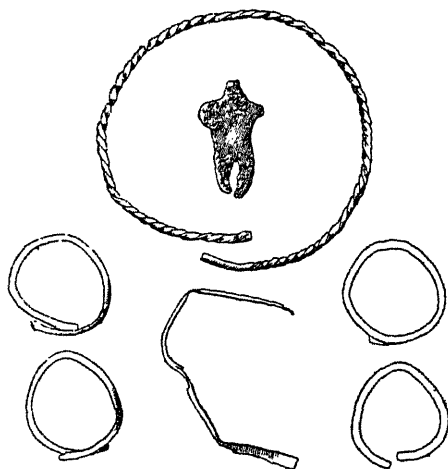

FIG. 18.

Fig. 18. is an illustration of one branch of Ægean art that was not represented in the tombs of Pelos. Metal was at that period in very scanty use in the Cyclades, if used at all. Mr. Bent found none in the

earlier cemetery of Antiparos. But from the other he brought home a small collection of metal ornaments, which is now in the British Museum, and which, with the permission of Mr. A. S. Murray, is here reproduced (Fig. 18).

Mr. Bent's description of the different articles is as follows (*J. H. S.*, v., p. 53): "In the next place I found a considerable number of metal ornaments in the graves at Antiparos. I have in my possession a narrow twisted torc of silver, with a large percentage of copper; rings of silver with the same oxide as on certain rings found in Etruria, which oxide cuts like horn; a band of bronze with about 75 per cent. of copper in it, and covered with an incrustation of red oxide and green carbonate of copper; and that little silver figure I mentioned above, thus giving us silver, copper, and bronze in use at the time of these graves."

The rings, or rather bracelets, on the left side of the lower part of the illustration are flat on the inside and slightly arched on the outside; those on the opposite side are round. They are without exception very small for the wrist of a grown man or woman (cf. Schliemann, *Ilios*, 250, 458). The bronze band between them widens out at either end and has no holes for attachment. I do not know of any parallel to it.

On one point Mr. Bent seems to have been mistaken. The small idol in the centre of Fig. 18 is not of silver, but lead. It is 5 cm. high, and weighs 27.32 grammes. It has been supposed of late that the island idols were invariably made of stone.* But clearly Ross was right in saying that lead also was used; and the only other example known, the lead idol in Athens, which Dr. Wolters, mainly on *a priori* grounds, suspected of being a forgery, need be suspected no longer. The head and the left arm of the idol have been broken off—both apparently in recent times. The arms are to be regarded as bent at the elbow and held to the breast; for there is a break at the left shoulder, another break lower down, and a bit of oxidised surface between, which shows that the arm was clear of the body at this point. There is a very good instance in the Louvre (*Salle de Clarac*, G.) of an idol with arms bent, like those of our figure, in a semi-circular curve,

* *Ath. Mitth.*, xvi., p. 55; Blinkenberg, p. 15.

and continued across the breast. But one need not go the length of believing that all the primitive fiddle-shaped idols are meant to be represented with bent arms and bent legs.

Wolters has suggested (*Ath. Mitth.*, xvi. 53) that the more primitive specimens, such as *J. H. S.* v. 49, Figs. 1, 2, are to be regarded as squatting. Reichel (*Vorhell. Götterculte*, 80), reverts to the Istar myth, and thinks the idols represent the goddess *in the tomb*; the folded arms and closed legs copy the attitude of a dead body; the few seated idols (*Ath. Mitth.*, xvi. 53) copy, more realistically, the seated corpse in a cist-sepulchre. But (1) without entering into the Istar myth, it may be remarked that the naked images are not all female; several are certainly male (*e.g.*, *J. H. S.*, v. 51; *Ath. Mitth.* xvi. 51).

(2) A great number of the early specimens (*e.g.*, *J. H. S.*, v. 50, Figs. 3, 4, 6), have for arms two short stumps, which stick straight out; and one does not hold one's arms so in a tomb of three feet by two. In the second of the two most common types (*ibid.*, Figs. 5, 7, 8) the arms are laid across the breast, not because this type is copied from a dead body, but because the image-maker wishes to make the image more life-like, to show the whole arm instead of a stump, and this is the easiest way to do it. The slight bending of the legs in the more advanced of these figures is perfectly explained by the theory that the sculptor was limited by the boardlike form of his material (see *ante*, pp. 27-29).

(3) It is far from certain that the idols were made solely or primarily for the tomb. It is true that they have been found chiefly in tombs; but then no settlement of the same age as the cist-tombs has been explored. Strictly it would be as fair to conclude that the early stone vases were only made for being put in graves. But at Hissarlik—a settlement of a similar people—similar idols were found in any quantity. At Phylakopi also idols have been found, though not a great many. Again, a number of the idols (*e.g.*, *Cret. Pict.* 128, Fig. 133) are pierced for suspension, and no one can suppose that either idols or vases with suspension holes were hung up in a prehistoric tomb. Two further arguments to the same effect are given by Blinkenberg (p. 15): some of the idols can be seen to have been repaired before being laid in the grave; others were made so large that they had to be broken in order to get them in.

C. C. EDGAR.

NOTES FROM THE CYCLADES.

(PLATES IV. AND V.)

THE following notes deal partly with some results of our first season in Melos, partly with Ægean objects in English collections. Mr. Cecil Smith and Mr. Edgar have given me help which I gratefully acknowledge. Incidentally some progress has been made with the task, which Dümmler deemed hopeless, of identifying the scattered contents of the tombs at Phylakopi. Much remains to be done by the comparative study of objects on museum shelves. Still more necessary is the systematic excavation of cemeteries, a branch of research which Greek archæologists have too often left to peasants in the pay of dealers. It is for the present generation, warned by the squandered riches of Eretria and Tanagra, to ensure that some at least of the Ægean cemeteries are explored in the interests of science.

I.—PRE-MYCENÆAN POTTERY FROM MELOS.

For comparison with Mr. Edgar's finds I publish some other specimens of early Melian pottery which were obtained at or near the ancient settlement of Phylakopi before the excavations in 1896. The illustrations, re-drawn in ink by Mr. F. Anderson over full-size pencil drawings by Mr. Charles Clark, are in every case one-third linear of the original.

1. Bought with No. 2 from the owners of a cave-dwelling near the ancient site. The one was doing service as a salt-cellar, the other as a receptacle for coffee-beans. The finder was known to have dug in both the Phylakopi cemeteries; he was away from the island, and we could obtain no more precise information. There can be little doubt that both vases come from the graves beside the sea at Kapro, which appear to be earlier than those on the hill behind the fortress.

“In form and fabric,” writes Mr. Edgar, “they belong to the same class as the Pelos vases, but in both respects they are considerably advanced.” No. 1 is of blackish-brown clay with a fine texture, and retains traces of a reddish slip. An earlier instance of the same shape

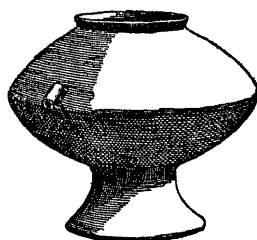

1.—FROM A GRAVE AT PHYLAKOPI. Height 9 cm.

occurred at Pelos, Fig. 15. In our miniature example there are signs of increased skill in the curve of the foot, the thinness of the walls, and the symmetry preserved between the upper and lower halves of the body, which pass into one another almost at a right angle. The narrow mouth, with its rim to hold a flat lid, marks the pot as a storage vessel and not a drinking-cup. On the shoulder is a tubular projection to which the lid was probably tied. Older vases have four such handles for the double purpose of suspension from the roof of the primitive hut, which had no “cupboard,” and of fastening a lid to exclude the smoke;

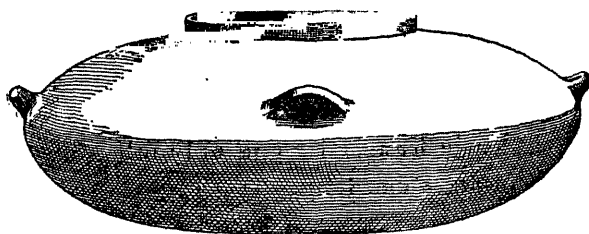

2.—FROM A GRAVE AT PHYLAKOPI. Height 9 cm., width 22 cm.

and on large vessels, such as No. 2, the full number was retained for convenience of carriage : οὔρα δ' αὐτοῦ τέσσαρ' ἔσαν.

2. Bought with No. 1, and, like it, hand-made.

Same clay, covered with a dark-brown slip, the surface polished

and without ornament of any kind. The form, but for the greater freedom of the four ear-handles, is that of No. 1 without its foot. It has a special interest, because it outlived a variety of early types with the same returning shoulder and contracted mouth, and remained in use through the Mycenæan period, thus constituting a link between the rude beginnings of industry in the islands and the finished products of Mycenæan civilisation.* The four suspension handles are pinched out of the substance of the body, not separately moulded and affixed. In spite of their solidity they can hardly have been meant to resist a direct strain; when the vase was carried or hung up, the weight would be borne by cross strings under the body, the handles being merely guides to keep the carrying strings in place.

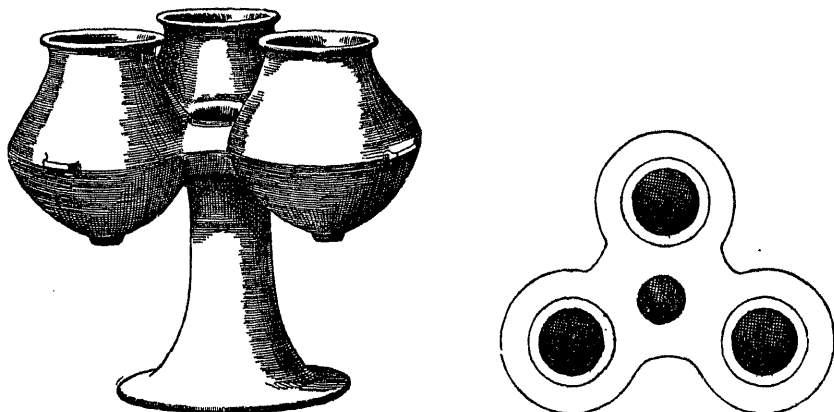

3.—FROM THE KAPRO CEMETERY AT PHYLAKOPI. Height 15 cm.

3. Found broken in a shallow grave, cut in the soft pumice on the promontory called 'ς τὸν Κάπρον.† The only other object in the grave was a blade of obsidian, 5 cm. long.

Both the fabric and the form are unusual. The vase is hand-made, of highly micaceous grey-black clay, with a smooth and almost greasy pale grey surface. Its colour, lighter than that of the characteristic grey pottery of the Mycenæan Troy, may be the result of imperfect firing, or may be due to an experiment with the fine white china-clay

* Furtwängler u. Löschcke, *Mykenische Vasen*, Taf. xlv., 32. Cf. *J. H. S.*, xvii., p. 75.

† An early site in Amorgos bears the same name. *Ath. Mitth.*, xi. 28.

which occurs in various parts of Melos, notably a mile south-west of Phylakopi.*

The form is original and graceful. Round a hollow stem which spreads below into a trumpet-shaped foot (the latter somewhat less flat than it appears in the drawing) are symmetrically grouped three cups with round bases, swelling bodies, and contracted mouths. They have a button-like knob at the base, projecting unperforated handles, and slightly everted rims. They do not communicate internally.

There is no ornament of any kind. The vase seems to mark a stage at which the potter has newly obtained mastery over his material, and finds an outlet for his inventive powers in ingenious construction rather than in external decoration. Groups of three or four cups, without the central pedestal, are fairly common in ancient pottery; they occur, to give a few instances, at Troy, at Ialysus, in Cyprus, in South Italy, at Rome, and in late Hallstatt times in the Rhenish Palatinate.†

But there is no need to go far afield for analogies. Our vase is principally interesting as a forerunner of the elaborate cluster-vases of the so-called *κέρνος* type, and they, so far as I know, have hitherto been found only in Melos. It is the first of a local series, culminating in the remarkable vase with no less than twenty-five cups, which is represented on Pl. IV., and will be discussed in a later section. Meanwhile, it is important to observe that, while the later members of the series are approximately contemporary with the beginnings of Mycenaean art, the prototype has considerable affinity with the pottery of the cist-graves. It is hand-made and hand-polished. The germ of its trumpet-shaped foot is present at Pelos (page 45, Figs. 14 and 15); its cups, regarded singly, have the form of Pelos, Fig. 2; the un-

* The local name for Cimolite, the *Κιμωλία* of Aristophanes, as well as for the china-clay, which is a different substance, is *Πηλός*. The former gives its name to *Πηλός* in Kimolos, the latter perhaps to the site in Melos excavated by Mr. Edgar. Was the clay for the pottery obtained on the spot? There is also an islet off the north-east coast of Melos, called Pelonesia, Pilo on the Admiralty Chart. For an account of the different clays and their behaviour in the oven, see Fiedler, *Reise durch Griechenland*, II., pp. 392-441.

† In a collection of funeral pottery from the dolmens of Japan, which has lately been acquired by the British Museum, there is a vase distantly resembling No. 3, a cluster of three cups on a high pedestal. See an article by Mr. Gowlands in "Archæologia," lv., pp. 492-500, and Pl. XLI., Fig. 2. Groups of small cups on a common stem occur in modern Kabyle pottery. The remarkable three-bodied jug found at Aphidnae (*Ath. Mitth.* xxi. Taf. xiv.) seems to be developed from the Aegean jug with conical body, incised ornament, and lanceolate mouth, of which there are specimens (a) at Sèvres from Melos, Brongniart and Riocreux, xiii. 7; (b) at Athens from Amorgos, *Ath. Mitth.* xi., Beilage 2, 1; (c) in Brit. Mus., from Christy Collection.

pierced ledge-handles occur on a deep hand-made jar from Antiparos.* It needed only the caprice of an ingenious potter to combine familiar elements into a composite vase.

The grave in which No. 3 was found lies near a group which had recently been plundered. To judge from fragments which lay in them they had contained pottery of the same early period. Nos. 1 and 2 may have been the fruits of this excavation. A trustworthy local digger told me that marble "mannikins" (*ἀνθρωπάκια*), by which he can only have meant figures of the usual island type, had been found in graves upon this promontory.† This part, therefore, of the Phylakopi cemeteries was in use from the "Amorgos period" of the Bronze Age onwards.

The changed method of making the graves implies an advance of culture, not necessarily a change of population. The transition from small graves dug in the earth and lined with slabs to graves of liberal dimensions cut in the rock is not likely to have come about until bronze tools were in common use. Where the soil was hard it was difficult to dig a large grave with tools of wood or stone. So the corpse seems to have been trussed, as in many other countries, and buried in the smallest possible hole. The lining of slabs made it easy to open the grave and use it again and again. In islands where the rock was hard, Salamis, for instance, cist-burial in the earth naturally lasted longer than in Melos, where with the help of bronze cutting-tools it was as easy to hew a grave in the soft pumice as to dig it in the ground.‡

4. Red clay with traces of darker red slip. Perhaps wheel-made. Picked out of the earth thrown from a plundered grave on the hill south of the ancient fortress. The whole of its eastern slope is covered with tombs, which on the whole are later in date, to judge from the pottery round them, than those of the Kapro cemetery, a quarter of a

* British Museum, A. 98.

† When Dr. Blinkenberg asserts that no antiquities characteristic of the pre-Mycenæan period have ever been found at Phylakopi (*Antiquités prémycéniques*, p. 36), he is only giving his own interpretation to the facts recorded by Dümmler, not speaking from personal knowledge of the site. His valuable classification of the evidence will be found in *Mém. Soc. Ant. du Nord*, 1896.

‡ The finding of an obsidian blade with No. 3 is no argument for or against this dating, for it is clear that in the Ægean, as in Sicily and Mexico, these cheap and efficient razors held their own after the introduction of bronze, just as in Egypt razors of flint, a worse material for the purpose than obsidian, have only recently been replaced by steel.

mile away, in which No. 3 was found. Most of the fragments here are painted, and many of them belong to large vessels in the early Mycenæan style. Many of the graves are pit-graves, but at one place the rock has been scarped, and more pretentious tombs have been cut into it horizontally; one of these has an inner chamber, and is said

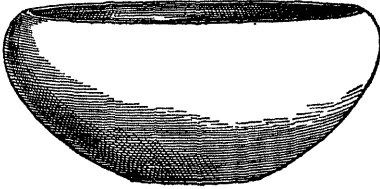

4.—FROM THE HILL-CEMETERY AT PHYLAKOPI.
Height 7 cm.

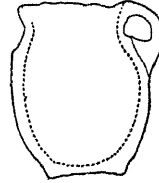

5.—FROM THE FORTRESS AT PHYLAKOPI.

to have yielded large quantities of gold. The grave in which No. 4 was found lies farther inland than these distinctively Mycenæan tombs, and can hardly be an outlier from the older cemetery by the sea. Dümmler records the form as occurring in the hill-cemetery.

5. This is a small roughly-made jug of coarse brown clay. Its upper rim is broken. The handle is not of the primitive form; and the vase may quite well be clumsy work of a relatively late date.

II.—THE SO-CALLED KERNOI.

The graceful triple vase from the Kapro cemetery at Phylakopi in Melos (Fig. 3 above), furnishes a clue for interpreting a little-known series of vases which seem to have come from the same site.

Pl. IV. shows their general appearance, and explains the structure of a more than usually complicated specimen by means of top and bottom views, for the ingenious drawing of which I have to thank Mr. F. Anderson. They are composite vases, consisting of a cylindrical stem with bell-shaped foot, a central bowl, and a single or double circle of cups. The clay varies from yellow to reddish-brown; the surface is covered inside and out with a coarse gritty slip, once white, but now yellow or grey, and decorated with stripes, zigzags, and cross stripes applied in dull brown paint. The component parts were shaped separately upon the wheel, the slip and decoration being added without

its aid after the building up of the whole. The series must be contemporary with certain beaked jugs and other painted pottery of the latest pre-Mycenæan period which have the same white coating and linear decoration in lustreless brown paint.

First Type.—The central bowl is a continuation of the stem, and supports a circle of cups which are attached to its circumference by horizontal ties.

- | | | |
|---|--------------------------|---------------------|
| I. Lewis Collection, Cambridge. | Single circle of 8 cups. | Provenance unknown. |
| II. Athens Museum, 838. | „ „ 10 „ | „ „ |
| III. Sèvres Museum, 1419 ⁹ . | „ „ 10 „ | From Melos. |

III. is represented on Pl. IV. Fig. 1, after Brongniart and Riocreux, *Musée de Sèvres*, Pl. xiii. 1.

The height of I. is 15 cm., of III. 30 cm.

Second Type.—The central bowl and an outer circle of cups are suspended by horizontal ties from an inner circle of cups which springs from the margin of the stem. IV. has only one circle of cups; V. no central bowl.

- | | | |
|-------------------------------|--------------------------------|-----------------------|
| IV. British Museum, A. 1556*. | Single circle of 7 cups. | From Melos. |
| V. Athens Museum, 833. | Inner circle 6 cups, outer 11. | (Provenance unknown). |
| VI. Sèvres Museum, 3552. | „ 6 „ „ 12. | From Melos. |
| VII. British Museum, A. 1555. | „ 7 „ „ 13. | „ Melos. |
| VIII. Eton College Library. | „ 9 „ „ 15. | „ Melos. |
| IX. British Museum, A. 1556. | „ 10 „ „ 15. | „ Melos. |

IX. is the subject of Pl. IV. Figs. 2, 3, 4. VII. is figured in Birch, *Ancient Pottery*, p. 147. The height of IV. is 20.3 cm.; of VII., 33.5 cm.; of VIII., 35 cm.; of IX., 32 cm.

The order does not pretend to be chronological, but it is evident that the more complicated specimens, which are also the better made, are the outcome of a process of evolution. We cannot at present supply the intermediate stages between the triple vase from Kapro and the simple kernoi with seven or eight cups, but we may conjecture that the central bowl, which is absent both in the prototype and in No. V., was originally separable from the stand. The ledge-handles of the Kapro vase are retained on a vase from Melos which consists of two slender cups like those of the later kernoi coupled together.* We can even follow the transition from the swelling cups of Fig. 3 to the slender alabastoi of No. IX.; the broader cups of the smaller examples, No. IV. in particular, show how the shape was modified to enable a greater number to be packed into the available space.

It is difficult to imagine what practical use a primitive community can have found for these ponderous and fragile clusters of tubes. They have been called candelabra and flower-stands, as well as ἀλαβαστοθήκαι

* At Sèvres. Brongniart and Riocreux, *op. cit.*, Pl. xiii. 3.

and κέρνοι.* If fragments are found in the dwellings at Phylakopi, it will be worth while to consider whether they may not have been used as lamps; in one of the "New Race" graves Mr. Petrie found a deep vase with a narrow neck, which, in spite of its unpromising shape, had been used as a lamp with a floating wick.†

If, however, they prove to have been made solely for the service of the dead, we may obtain a clue to their original use by comparing the three cups of the Kapro vase with the three hollows of the very early libation-table obtained by Mr. Evans from the Diktaean cave. The antiquity of the χοαὶ τρίσπονδοι, the customary Greek drink-offering to the dead and to the powers of the underworld, seems to be carried back beyond the tragedians, beyond Homer, to a period roughly contemporary with the Twelfth Dynasty of Egypt. The three miniature πίθοι of the Kapro vase may have contained the elements of the triple libation.‡ The subsequent multiplication and consequent modification of the cups, effected, as we have seen, by a gradual evolution, may be explained by the tendency of barbaric art to magnify and elaborate simple articles for the sake of display, and without any regard to practical convenience.§ We have a further illustration of this tendency in the remarkable openwork stem of No. IX., which displays the potter's ingenuity and audacity at the cost of impairing the strength of the vase and without increasing its usefulness (Pl. IV.). Possibly the idea was borrowed from an imported bronze cauldron-stand. It was certainly in imitation of a bronze λέβης that the potter affixed three flat-topped hooks or handles to the rim of the central bowl

* Κέρνος is explained by Athenaeus, 478, as ἀγγεῖον κεραμεῶν ἔχον ἐν αὐτῷ πολλοὺς κοτυλίσκους κεκολλημένους. It was used to contain a variety of offerings in the Corybantic rites. Hesychius explains it as στεφανίς. Hence Panofka, who introduced the word into archaeological nomenclature in his *Récherches sur les vrais noms des vases grecs* (Pl. V. 53), applied it to a ring-vase surmounted with cups, a form that occurs in early Cypriote, and again in Corinthian pottery. It is not very appropriate as a name for the pre-Mycenæan cluster-vases of Melos, but may be retained for want of a better.

† *Nagaða and Ballas*, Pl. V. 23.

‡ Usually milk, honey dissolved in water, and wine, Aesch. *Persae*, 609; Eurip. *I. T.* 162; *Orestes*, 115; Soph. *Ant.* 431. The libation to the Erinyes was made twice with water, the third time with honey dissolved in water, Soph. *O. C.* 479. In *Odyssey*, x. 519, xi. 27, the offerings are dissolved honey, wine, water. See Mr. Evans' remarks on the Cretan libation-table, *J. H. S.* xvii. pp. 350 ff. and 358. Another parallel is the triple *Duenos* vase, found at Rome; its inscription shows that it was designed as a funeral offering. *Mélanges d'arch. et d'hist.*, 1882, Pl. iii.

§ The five-and-twenty receptacles can hardly have been filled with different kinds of food and drink; rather, perhaps, with unguents. Cf. a ring-vase of nine small jugs, from Thebes, *Arch. Anzeiger*, 1895, p. 33, Fig. 1.

(Pl. IV., Fig. 2); they represent the hooks used for hanging the cauldron over a fire, which were to develop later into the familiar griffin's head handles.*

It was shown at the beginning of this paper that the Kapro vase had characteristics in common with the primitive hand-made pottery of the Amorgos period; we now see that it is the prototype of a series of wheel-made vases which bring us in sight of the far higher achievements of Mycenæan craftsmen. Resemblances in the handiwork of different peoples and periods can so often be accounted for by similarity in the conditions of production, that it is dangerous to infer direct influence even where it seems geographically and chronologically possible. In the present case, however, we can strengthen the argument for continuity of tradition by tracing the kernoi not only to the island, but to the very site where their primitive prototype was found.

On the ground of their fabric the kernoi must be classed with the beaked jugs and other painted pottery of the pre-Mycenæan period. Since they come from Melos there is a presumption that they come from Phylakopi; no other cemetery of that period has been excavated in the island, though others may exist. A strong argument is furnished by the date at which they were acquired. Local tradition in Melos asserts that the tombs at Phylakopi were plundered wholesale by a party of Cretan adventurers about the time of the War of Independence (1821-1829); the same story was told to Dümmler in 1886 and to ourselves ten years later, and there is no reason to doubt it.† Now, of the list given above, Nos. IV. and VII. are part of the collection formed by Burgon, who excavated in Melos, as Mr. Cecil Smith tells me, probably at some time between 1810 and 1815; No. VIII. was obtained by Captain Copeland, R.N., while engaged on the Admiralty survey in Greek waters "between 1826 and 1836"; and No. VI. was a gift from Bory de St. Vincent, who may have obtained it when he visited the Cyclades with the "Expédition Scientifique de Morée" in 1829. Further, among the Burgon vases in the British Museum and the Copeland vases at Eton there are vases labelled "Melos," of pre-

* The arrangement for suspension is well seen in the case of a red-ware cauldron and stand from Falerii, now in the British Museum. Round the cauldron are griffins' heads with suspension-chains hanging from their jaws. Cf. *Olympia, Die Bronzen*, p. 115; Schliemann's *Atlas Trojan. Alterthümer*, Taf. 154, &c.

† Ross heard of both cemeteries in 1843, but did not visit them.

Mycenæan or early Mycenæan style, which closely correspond with the fragments strewn about the cemeteries and fortress of Phylakopi.* This is also true of a set of twenty-one vases, including the kernos No. III., which came to Sèvres from Melos in 1831. We may, therefore, conclude that the Melian κέρνοι were found in one or other of these cemeteries, and that they are directly descended from a simpler type which is represented by the triple vase from Kapro.

The form appears to be a local development. On the other hand, the decoration is so closely allied to that of the pre-Mycenæan geometric ware, which has been observed in Attica, Ægina, and Sicily, as well as in the Cyclades, that in the absence of evidence as to their provenance Dr. Stais was inclined to regard the two kernoi in the Athens Museum as of Æginetan fabric.† Melos has a stronger claim. But it would be premature to lay stress on the fact that at present the type seems indigenous at Phylakopi, or to infer anything as to the place of manufacture, until the surrounding area has been more fully explored. The cave of Kamarais in Crete, the Attic tumulus of Aphidnae, the beehive tombs on Mount Ossa, have shown how much we have still to learn about the varieties and the distribution of early pottery.

III.—TEXTILE IMPRESSIONS ON ÆGEAN POTTERY.

In the last volume of the *Annual*, p. 142, I described a grave in the prehistoric necropolis of Khalandri,‡ near Cape Κροκιδᾶς in Syra, and men-

* A jug from Melos, of the early beaked type, was in the Dresden Augusteum as early as 1830. Fiedler, ii. p. 376; Taf. iii., Fig. 18. The stone pyxis from Melos, now at Munich, has been assigned with great probability to Phylakopi. A beaked jug, which came to the Louvre without provenance in Louis Philippe's reign, is catalogued by M. Pottier as Italian, *Vases du Louvre*, Pl. 29, D. 5. Many antiquities from Melos must have found their way to France in the early part of the century. The French vice-consul was an ardent excavator, and French ships frequented the island.

† 'Εφ. Ἀρχ. 1885, p. 255, Pl. X. 1—7.

‡ Dr. Blinkenberg's contention (*op. cit.* p. 35, note 1), that this cemetery contained graves of late date, was not borne out by my own enquiries and observations on the spot. The evidence offered is: (1) Pappadopoulos speaks of "pyxides en albâtre et à couvercle tournant et se fixant comme celui des théières." Blinkenberg assigns them to the fourth or fifth century B.C. (2) Dr. Pollak saw two b. f. vases in Hermupolis which were said to have been found many years before at Khalandri (*Ath. Mitth.* xxi., p. 189). The answer to (1) is that the pyxides may well have been pre-Mycenæan vessels like the marble vase, seen by Pollak in Siphnos, which had "Windungen im erhöhtem Halse um einen Deckel anzuschrauben" (*loc. cit.* p. 210). As for (2) the evidence is of a most unsatisfactory kind.

Khalandri, like Phylakopi, is remote from the classical centres of population. The juxtaposition

tioned this vase, found in it, as "a round hand-made bowl of dull red ware, black in the break, without ornament save for a broached pattern under its base." The clay differs from that of the early vases in Melos; it is more friable, and contains a greater proportion of mica. The principal interest of the pot lies in what I then described as the broached pattern under its base. In the light of an important note printed by Mr. J. L. Myres, in the *Journal of the Anthropological Institute*, 1897, p. 178, it becomes probable that these markings are the impressions of a plaited or woven mat on which the bowl was built up.

Mr. Myres publishes a photograph of a fragment of pottery picked up on the site called τζή βήλας in Amorgos. "The remarkable feature is that the base bears the clear impression externally of a rush mat upon which the vessel has been formed. . . . It appears probable that the mat thus recorded was used either (1) to prevent the vessel from sticking to the ground while drying in the kiln, or else (2) during the actual

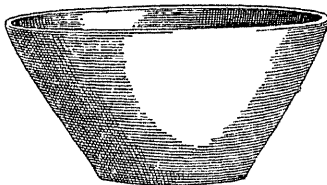

6.—FOUND IN A GRAVE AT SYRA. Height 6 cm.

manufacture of the vessel." He decides in favour of the latter hypothesis, remarking that "small vessels can be handled upon the level surface without much fear of distortion; but a jar of the size of this specimen, with a base of some 10 inches (25 cm.) diameter and walls of considerable thickness, would certainly be so heavy that it could not be turned round, at the convenience of the potter, without great risk of distortion. If, however, its foundation was laid on a circular mat of the size of the intended base, and with a slightly thicker knot in the centre, as in this instance, close or continuous contact with the ground would be avoided, and the central pivot would to some degree supply the place of a turn-table or potter's wheel."

Pl. V. 1 represents the upper side of a paper impression taken on both sites of graves containing marble idols and graves containing painted pottery is a strong argument against an interruption of culture such as has been assumed.

from the base of the Syra vase, and therefore reproduces the general lines of the original mat; the surface of the base is, as it were, a negative from which we obtain a positive. It shows a loosely woven fabric with a warp of thick single straws or rushes, crossed more or less at right angles by a thinner woof. There is no central 'knot, and nothing to show that the mat bore any intentional relation, in size or shape, to the pot which was formed upon it. The whole has been pulled out of shape by a "circumferential strain" like that of which Mr. Myres detected traces upon his fragment, with the difference that in that case the strain was applied in the direction of the hands of a watch, while here it has been applied in the opposite, or *withershins* direction. The Amorgos pot was so heavy that some means of turning it in the shaping was a convenience, if not a necessity. In the case of the little bowl from Syra, the use of the turning-mat is seen in the regular horizontal streaks in which the thin red slip was laid on; one hand kept the mat turning, while the colour was applied with the other. Mr. Edgar, who has kindly examined the surface for me, thinks that the potter used his thumb instead of a brush.

Mr. Edgar sends me from Athens the paper cast of a fragment bearing similar textile impressions, which he has discovered among the pottery from last year's excavations in the fortress at Phylakopi. It is represented full size in Pl. V. 2. The warp consists of double rushes, and the texture is very distinctly seen.

Thus three instances of a previously unknown technique have come to light in rapid succession. Since discovery begets discovery, we may expect that the method of building up earthenware vessels upon a basket-work mat, which is now recorded for Amorgos, Syra, and Melos, will be found to have been a common possession of the inhabitants of the Ægean, and perhaps of a larger area.*

* Dümmler figures part of an earthenware platter, "Welche wol einen Strohteller nachbildete," from a grave in Amorgos (*Ath. Mitth.* xi., Beilage, ii. c. 2, p. 19), and mentions a similar imitation of a straw-mat from an early grave at Hagia Paraskeve, in Cyprus (p. 38). A large earthenware lid from Antiparos (*Brit. Mus.*, A. 101), bears a pattern which seems to be derived from a rush-work original, which had the same "confused knot in the centre," and "radial warp" as Mr. Myres' specimen. The latter is now in the Ashmolean.

The textile impressions found on primitive pottery in the United States are the result of building up or moulding the vessels in baskets and nets. See the article by Mr. William H. Holmes in the *Third Annual Report of the Bureau of Ethnology*, 1881-2, pp. 397-425, Pl. xxxix.

IV.—STONE DISHES OR TROUGHS.

Some sixty years ago Fiedler, the German geologist, brought back from Naxos the singular implement of white limestone which is reproduced in Fig. 7. He had reason to suppose that it had been found with a marble idol in a grave near Trymalia.* It is easy to smile at his suggestion that it served as *eine heilige Schwinge* for the figure found with it, but by no means easy to give a satisfactory explanation of its use. This paper was already written and the block for Fig. 7 prepared from Fiedler's illustration, when I learned from Professor Treu that the original is preserved in the *Königliche Skulpturensammlung* at Dresden. With characteristic kindness Professor Treu has sent me a cast, and thus made it possible to take account of certain defects in Fiedler's drawing † and to compare the Dresden specimen with three somewhat similar objects in English collections.

Pl. V., Fig. 3 (*a*, *b*, and *c*), represents a trough, also of white limestone, which comes from Amorgos and is now in the Ashmolean

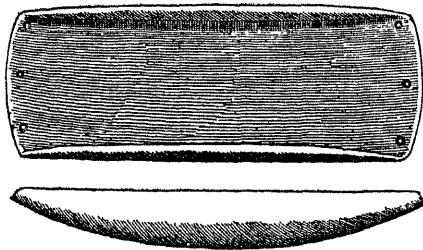

7.—LIMESTONE DISH FROM NAXOS. Quarter length of original.

Museum at Oxford. I have to thank Mr. Arthur Evans for permission to publish it, and his assistant, Mr. C. J. Bell, for the drawings, which are reduced on the plate to one-half (linear) of the original. It is smaller and less carefully made than the implement from Naxos. In spite of a slight depression at the centre of the longitudinal hollow it was certainly not meant as a recipient for a liquid. The irregularity

* Fiedler, *Reise durch Griechenland* (1834-7), Leipzig, 1840, ii. Taf. II. Fig. 3*a* and *b*. Cf. p. 315.

† The underside is less convex than in the drawing; the vessel stands steadily and does not rock. One rim is chipped. The hole at one angle is double; the maker bored from both sides and the two holes did not meet.

of the central depression, considered in conjunction with some striations at one end, suggests that the stone has been used for grinding some hard substance, perhaps for polishing bone pins or arrow-heads, or for mixing colour.

Two flatter and heavier dishes form part of a group of marble vessels, formerly in Lord Belmore's collection and now in the Egyptian department of the British Museum, to which Mr. Edgar has already referred. Wherever they were found, their material and form are strong evidence that they were made in the Cyclades.* The group consists of two jars, evidently made as a pair, and two flat dishes, also made as a pair—they are of the same length. It is interesting to compare their dimensions with those of the dishes already described.

I. Ashmolean Museum, from Amorgos.	Length 18, width 6 centimetres.
II. Dresden Museum, from Naxos.	„ 22 „ 8 „
III. British Museum, 4664.	„ 21 „ 14 „
IV. British Museum, 4665.	„ 21 „ 10 „

There is a remarkable resemblance between II. (Fig. 7) and IV., closer than that between IV. and III. I. stands somewhat apart.

They differ in the provision made for suspension. IV. has a hole at each corner, while III. has two knobs projecting at each end, those at one end pierced, those at the other unpierced. II. has three holes at each end, and I. has no holes at all. It follows that the holes were not essential to the use of the vessel, but were used for hanging it up by a string when not in use. It was convenient to have a double set of holes, four or six, in case the friction of the string wore through the outer edge of the holes, as has happened to three out of the four perforations of IV.

We cannot expect to determine with certainty the use for which these objects were made. They are too flat to have served as lamps. The lamp found at Mycenæ and figured in Tsountas-Manatt, p. 80, is a trough of blue schist, 8 ins. long and $\frac{3}{8}$ of an inch deep. Another of white marble was found at Thorikos. They were probably found in

* See p. 48; Mr. Cecil Smith's note on the probability that Lord Belmore obtained them in Greece is confirmed by the course of his travels, of which there is an account by Robert Richardson, M.D., entitled *Travels along the Mediterranean . . . in company with the Earl of Belmore*, London, 1822. On their way to the East in 1817 they visited Paros and Antiparos, and "the tombs of Delos and Antidelos." On their return in 1818 they spent four days at Paros, six at Delos, and one at Melos. See vol. i. p. 12; ii. p. 522.

graves, and that narrows the inquiry, for, as Dr. Blinkenberg has remarked, most of the objects deposited with the dead in Ægean tombs are either food-vessels, personal ornaments, or articles connected with the toilet, cosmetic-boxes, razors, tattooing-needles, and the like. Starting from this generalisation, we may regard the marble dishes as plates for food or mortars for the preparation of food, or as palettes for mixing the colours with which the islanders at this period decorated their persons.

The latter possibility is worth considering. In the graves of Naqada and Ballas, which in several respects present a parallel to those of the Greek Islands, Mr. Petrie and his companions found numerous slate palettes, pierced with a varying number of suspension holes and bearing traces of colour, and jars filled with thick palm-oil or vegetable butter. At a much later period, the royal mummies found at Deir-el-bahari "had their hair dressed and their faces painted before burial; the thick coats of colour which they still bear are composed of ochre, pounded brick, or carmine mixed with animal fat."* In classical Greece the anointing of the corpse is closely parallel to the ceremonial anointing of the statues of gods and heroes, and both customs are a natural extension of the oiling of the body, which was an essential part of the toilet. When, therefore, we find that certain ancient statues of Dionysos in the Peloponnese were smeared with "red grease" or with vermilion,† we may suspect that ritual has here preserved a custom that was once general. Tibullus is clearly echoing a Greek original when he declares that the rural worshippers of Dionysus wore paint.‡ We know that at Rome vermilion was applied not only to the face of Capitoline Jove, but to the bodies of generals at a triumph; and Pliny anticipated the methods of modern anthropology when he pointed out that it was a favourite colour among African tribes and that both chiefs and idols were decorated with it.§

The custom which left these traces in classical Greece and Italy has been brought home to the Ægean islanders by several discoveries

* Maspero, *Dawn of Civilisation*, p. 54, note 5.

† Paus. ii. 2, 5; vii. 26, 11; viii. 39, 4.

‡ Tibullus, ii. 1, 55. "Agricola et minio suffusus, Bacche, rubenti Primus inexperta duxit ab arte choros." The satyrs in the procession of Ptolemy Philadelphus were painted with ochre and other colours. Athen., 197D.

§ Pliny, *N. H.*, xxxiii. 112, a very important passage; xxxv. 157; xxxvi. 77. Cf. Plut. *Q. Rom.*, 98.

of red and blue pigments placed beside them in the grave, as well as by traces of colour, distinct from imitations of tattoo-marks, on certain marble idols. Just as the obsidian core provided the dead with the means of making new razors, so the palette or colour-slab would enable him to mix a fresh supply of colour. Moreover, the widespread idea that everything which had been in contact with the dead became *tabu*, and must be buried with him, would especially apply to the razors and the vessels containing paint and unguents which had been used in the funeral toilet.

The two marble jars and the two marble dishes from the Belmore collection seem to form a set. The jars may have contained the unguents with which the paint was applied.* Unfortunately the decisive evidence which can only be obtained at the moment of excavation is wholly lacking in the present case, and we must wait for the final solution of this, and many more important problems, until one of the Archæological Schools undertakes the systematic exploration of the island cemeteries.

V.—A PRE-MYCENÆAN WRIST-GUARD.

The object represented in Pl. V. 4 comes from Amorgos, and is now in the Ashmolean Museum. I have again to acknowledge the kindness of Mr. Arthur Evans in giving me permission to publish it, and of Mr. C. J. Bell in making the drawings.

Although at first sight it bears a general resemblance to the marble dishes discussed in the preceding section, it differs in two important respects. In the first place it measures only 9.4×4.8 cm. ($3\frac{3}{4} \times 1\frac{7}{8}$ inches), while the smallest of the preceding class measures 18.5×6.5 cm., and is considerably thicker; secondly, the low rim has the same degree of curvature as the interior, whereas in the preceding class the rim on the long sides connects the ends in a straight line. We have to deal not with a heavy trough, but with a small and neatly made concave plate. It might with some plausibility be explained as a palette. But anyone familiar with the stone "bracers" of the

* Pliny, *loc. cit.*, implies that the vermilion was mixed with unguents, *hac religione etiamnum addi in unguenta cenae triumphalis*. Primitive man finds it convenient to mix his red ochre with animal fat, butter or oil. Cf. W. Jöst, *Tätowieren, etc.*, p. 11, and references there given, and Mr. Frazer's *Pausanias*, vol. iii. p. 20.

northern Bronze Age will ask himself whether it is not more likely that we have here the first example of a pre-Mycenæan archer's wrist-guard.

Bracers or guards to protect the left wrist from the recoil of the bow-string are made nowadays of stiff leather. In the Middle Ages they were often of ivory. A grave-relief from Borcovicus on the Roman wall in Northumberland is thought to represent an archer with a bracer on his left arm,* and I suspect that we have the bracer itself in "a curious object of bone" which was recently dug up at the neighbouring fort of Aesica.† Going further back, we find it worn as a broad wrist-band on a bronze statuette of an archer found in Sardinia,‡ and in the same form on Egyptian monuments, where it also appears as a long pad secured by thongs about the wrist and elbow. The oblong stone plates which have been found in the British Isles, and more rarely on the Continent, with interments of the early Bronze Age, were first recognised as bracers by Thurnam, and have been fully described by Sir John Evans.§ The commonest material is a greenish chlorite or veined slate. They range from $2\frac{1}{2}$ to $5\frac{1}{2}$ inches in length, and from 1 to $2\frac{3}{4}$ inches in width, the Scottish examples being smaller than the English. The shape varies; most of them are rounded on the outer face and hollowed on the inner, so as to fit the side of the wrist, but a well-known example from near Devizes, about the use of which there can be no doubt, since it was found "between the bones of the left fore-arm" of a skeleton, is quite flat, and several like it are known. There is usually a hole in each corner, as there is in the marble plate from Amorgos (Pl. V. 4), sometimes only one and sometimes three or more at each end, by means of which the stone plate appears to have been sewn or riveted to a leather wrist-band. It is not clear whether the plate was completely encased in leather.

The most instructive of British finds was made in a rich grave near Driffeld,|| where a bracer, and a buckle which had probably formed

* *Lapidarium Septentrionale*, 240. Black Gate Museum, Newcastle-on-Tyne, No. 88. But the indications shown in the engraving are doubtful on the original.

† Figured in *Proc. Soc. Ant. Newcastle*, vi. (1894), p. 297. It is $3\frac{1}{2}$ inches long, and has a deep transverse sinking to receive a strap.

‡ In the British Museum, *Cat. Bronzes*, No. 337. Mr. Cecil Smith called my attention to it.

§ *Ancient Stone Implements of Great Britain*, 1897, pp. 425—430. Cf. *Catalogue of the National Museum of Antiquities of Scotland*, 1892, pp. 67, 188, 189.

|| Greenwell, *British Barrows*, Fig. 32, and p. 36; *Archæologia*, xliii. p. 427. The grave also contained a bronze dagger, large amber beads, and the skull of a hawk.

part of it, lay under the right arm of the dead. In the four holes of the stone plate, which is now in the British Museum, there are bronze pins or rivets, which must have served to attach the wrist-band, and the heads of the pins are decorated with gold caps.*

In one hole of the marble plate from Amorgos there is a green stain such as is left by decomposing bronze. Had the stain been deposited by some bronze object with which the marble was in contact in a tomb, we should expect to find traces on the surface, not on the inner wall of a narrow perforation. It is highly probable that the holes were once filled by bronze pins, like those of the Driffield bracer.

If future discoveries or comparisons confirm the suggested interpretation of the object figured in Pl. V. 4 as an archer's wrist-guard, we shall have an interesting proof that the islanders of the Amorgos period were acquainted with the use of the bow.

The absence of arrow-heads, as of other weapons, from the earlier graves, does not prove that the community was ignorant of all weapons, but rather that its life was peaceful. A race that lives by fighting seldom sends its dead unarmed to the lower world. The apparent absence of weapons for the dead and of walled strongholds for the living shows that at this period life in the Archipelago was still secure, and that, in spite of the free intercourse implied by the uniformity of the finds in different island cemeteries, navigation had not yet expanded into piracy. The marble-working island-race had at least a foothold on the mainland of Asia, as is shown by Mr. Bent's discoveries on the Triopian promontory.† Overland traffic to the Carian coast, and communication by small craft along the islands which run westward like a broken pier, will account for the presence of ivory and silver in Amorgos and Antiparos. The use of the bow and other rudiments of civilisation may have travelled to the Cyclades along this path from Asia, or by way of Crete from Africa. Mr. Evans has recently demonstrated the existence of very close and early intercourse between Crete

* These unusual embellishments, which could hardly have resisted the impact of the bowstring, and the circumstance that the bracer was found under the *right* arm, go to show that this specimen was worn for ornament rather than use. "I remarked no ornaments," says d'Albertis of a tribe in New Guinea, "except the bracelet worn to protect the arm from the bowstring. They use this also as a bag or purse, and put tobacco, or a spare string for their bow, and other little things in it." Dr. Haddon, who quotes the passage, mentions the wrist-guard among the finery which a native would wear "when specially dressed up." *Journ. Anthropol. Inst.*, xix. 370-2.

† *J. H. S.*, ix. p. 82.

and the Libyans of the North African coast, and Mr. Petrie has argued that the oared boats figured on the painted pottery found in "New Race" graves of about 3000 B.C. are likely to have been sea-going galleys.* The bow was the characteristic weapon of the Libyans, who served as mercenary archers in the armies of Egypt, and also of the Cretans, who served other Greek states in the same way. It was known and used in Crete from ancient times, for the arrow appears on very early seals, sometimes in connection with the wild goat.† If archery was "native" there, as Pausanias says,‡ and nowhere else in Greece, it was because the wild goat was native in the Cretan mountains. In Homer, archery is closely associated with the hunting of this particular quarry. The great bow of Pandarus the Lycian was made from the horns of a mountain goat which he had himself killed.§ Odysseus, a still more mighty archer, hunts the wild goat both on his voyage and in Ithaca.|| Wherever it was found—and its distribution in recent times and its prominence in early art indicate that it once had a wide range in the Ægean ¶—the needs of the chase, if not of war, must have established the use of the bow.

R. C. BOSANQUET.

* *J. H. S.* xvii. p. 372 ff.; Petrie, *Nagada and Ballas*, p. 49; see however C. Torr in *L'Anthropologie*, vol. ix. (1898), p. 32.

† Evans, *Cretan Pictographs*, p. 36; *J. H. S.*, xiv. p. 305.

‡ Paus., i. 23, 4.

§ *Iliad*, iv. 105—126. So κέρα, xi. 385, and *Od.* xxi. 395, of the bows of Paris and Odysseus.

|| *Odyssey*, ix. 118, 153. The goat-hunt on the desert island was doubtless a familiar incident in early Mediterranean voyages. Cf. xvii. 293—5 and xiv. 50.

¶ The present range of *Capra aegagrus* is from the Ægean, through Asia Minor, the Caucasus, Persia, and Beluchistan, to the north of India. In the Ægean it survives in Crete, Antimelos, and perhaps in Scopelos and Gioura, and was formerly reported in Samothrace and Carpathos. It is the principal progenitor of the domesticated goat, and since the young are easily caught and reared, it may have been introduced into many of the islands as a domesticated animal, and have reverted to a wild state where conditions were favourable. Homer's measurements—*τοῦ κέρα ἐκ κεφαλῆς ἑκκαίδεκάδωρα πεφύκει*—are justified by an unusually large twelve-year-old horn at South Kensington, which measures 48½ ins. along the curve. The native sportsmen of the Taurus (where Pandarus may have obtained his head) told Mr. Danford that they had seen horns of 6 and 7 spans, "which would give the enormous length of 5 ft." See *Zool. Soc. Proc.*, xliii. (1875), p. 458 ff.

ANCIENT SITES IN MELOS.

AFTER the close of the excavation season of the British School at Melos last year, I availed myself of the opportunity afforded by a prolonged stay to explore the island. The sites of Komia, Palæochori, and Hagia Kyriaki had been previously visited by me in company with Mr. Charles Clark, architect to the British School, but as the former visits had been limited to one day I revisited the sites mentioned more at leisure afterwards. In order to become more familiar with the people and the districts I stayed several days at or near each of the sites, sleeping usually in the threshing-floors near the farm-houses. The site of 'sta Pollonia on the coast east of Phylakopi, an early Greek burying place at the north part of the narrow neck of land which connects East with West Melos, and a Roman villa further south near the coast at Probatá, were also visited by Mr. R. Carr Bosanquet and other students of the school. A number of other sites, not mentioned by Ross and other writers, were visited for the first time.

For our purpose the island may be conveniently divided into two parts, East and West Melos,* connected by the narrow neck of land formed by the district of Probatá. East Melos is for the most part prevailingly agricultural, with vineyards, cornfields, and olive groves, while the country between Phylakopi and Palæochora is hilly and pastoral. The ancient Melians must have had the principal source of their prosperity in the rich districts of East Melos. West Melos is almost entirely mountainous and pastoral, with hardly any vineyards and very little field and garden cultivation, except along the south shore of the bay of Melos, and at two points in the interior, St. Helena and

* The sketch-map of Melos has been kindly drawn for me by Mr. Pieter Rodeck.

Angathia. We can imagine how this wild region with the adjacent Erimomelos must have formed the happy hunting ground of the ancient Melians. The mines, for which Melos has long been celebrated, are equally productive in east and west, especially in the hill country near the coasts. Flint is common everywhere, but the obsidian and white flint which plays so important a rôle in pre-historic Greek civilisation is found only in East Melos. The important mill-stone quarries, with

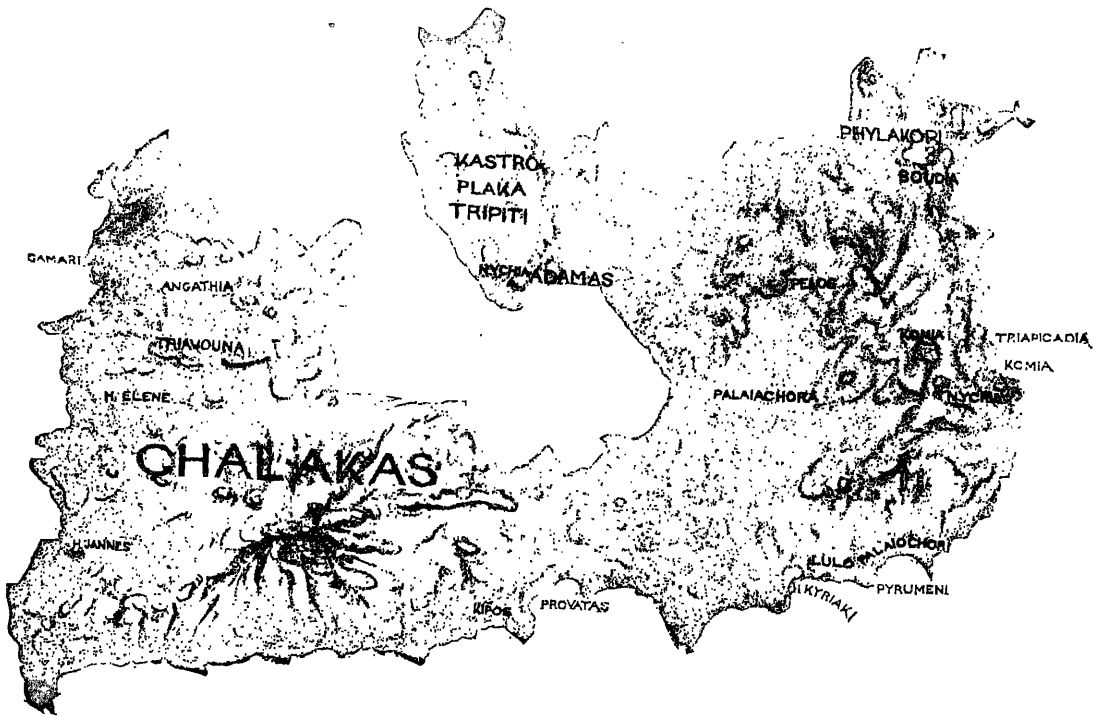

FIG. 1.—SKETCH MAP OF MELOS, SHOWING ANCIENT SITES.

which the pre-historic Melians were, to all appearance, unacquainted, but which, famous in classic and Roman times, still supply the modern Melians with their hand-mills, are confined to the hilly district north-east of Palæochori in East Melos.

I shall not describe the sites in the order in which they were visited, but, beginning in the east, make a circuit of the island, taking smaller sites by the way.

From Trypete, where we lived during the excavation season, to

Komia on the east coast of Melos is a journey of three hours' ride by mules. From Phylakopi, the pre-historic settlement on the north-east coast of the island, now in course of excavation by us, the distance is about an hour and a-half in a south-easterly direction. The road, after descending steeply from Trypete, leaves the port of Adamanta and the bay of Melos on the right, and gets into fairly level country forming one of the richest vineyard districts in Melos. For the first part of the journey the road is the same as that to Phylakopi, but about the middle of the vineyard country it branches north-east to Phylakopi and south-east to Komia. The vineyard district ends in a level plain at the foot of the hills, which forms a shallow lagoon in winter, but is cultivated for corn in summer. The extensive lagoons, the unhealthiness of which desolated the town of Palæachora in the course of last century, are only separated from this one by a spur of hills running south-westward towards the bay from the high pastoral country of East Melos.* The road passes through this spur of hills just where it leaves the main ranges, and the level lagoon and corn country of Palæachora lies at our feet, stretching westward towards the bay. Here, in the angle formed on the south by the projection of the above-mentioned spur from the hills to the east, and forming the north-east corner of the plain of Palæachora, lies the little district of Pelos with its pre-historic burying place (see *ante*, p. 36). The tomb region, chiefly to the left of the roadway before it descends into the plain, is at the foot of the white tufa hills bounding Palæachora on the east. Our attention had been attracted towards the site at the close of the excavation season by the proprietor, who brought us two small vases from a tomb which he came upon while digging his fields. On my visit the proprietor was unfortunately absent, and the site was shown to us by his son. The tomb to which the vases belonged had been about two feet down, ran lengthways into the hillside, and had been lined at the sides and ends with slabs of shale. The tomb had been covered in on the top with pink and white tufa blocks, hollowed out in a trough-like form. These stones covering in the top cannot have been of one piece, for one fragment is white, two others pinkish in colour. Three further fragments of these stones are in a low dyke bounding the field near where the tomb was

* Palæachora, the mediæval town, is to be distinguished from the ancient site of Palæochori on the south-east coast of Melos.

opened. The vases themselves, which were purchased by us, belong to the same class as many found in the pre-Mycenæan strata, at Hissarlik and elsewhere. They are hand-made, of rather coarse, not perfectly sifted clay, but with a kind of finer outside hand-polished slip, which, in the case of one of the vases, has not perfectly amalgamated with the body of rougher clay, and so has fallen away in patches. The other vase has a better-preserved surface, with an incised herring-bone pattern going up the body and round the neck. Both vases have at their widest circumference, arranged in pairs at opposite sides, vertically drilled tubular holes for suspension by means of strings. The imperfectly-sifted grain of the clay, the hand-make, the uneven firing over an open flame, the absence of paint or varnish, are all characteristically pre-Mycenæan, but the hand-polished surface and the incisions mark them out as late, rather than early, in this pre-Mycenæan era. Taking these vases in connection with even such information as we were able to obtain in the absence of the proprietor, I could see at once that we had here a tomb strongly resembling the tombs of Amorgos, described by Dümmler (*Ath. Mitth.*, 1886, p. 16). Another analogy of our site with certain cemeteries of Amorgos was that, while a good deal of pottery could be picked up all round and across the roadway, there was no trace of any pre-historic human habitation near at hand. A good many fragments picked up had colour and varnish, so that the site as a whole seemed to repeat the different stages, including the Mycenæan proper, represented at Phylakopi, with which pre-historic settlement, in the absence of any trace of primitive human habitation near, it is easiest to connect this burying place. In the lower, pre-Mycenæan stratum of Phylakopi, at a part completely separated from the upper Mycenæan level by a well-preserved schist pavement, I have since unearthed some fragments of incised hand-polished ware presenting a complete analogy to the pottery of Pelos (see *ante*, p. 43). Summer migrations to fertile districts like the plain of Palæachora, such as at present are customary among the Melians, may have been usual in remote antiquity, and would account for the existence of isolated burying places like this.*

After skirting the plain of Palæachora on the east for some distance,

* The necropolis at Pelos has since been excavated for the British School by Mr. Edgar (see p. 35).

the path ascends in an easterly direction into the hills, and brings us in an hour's time over the watershed into the valley district of upper Komia, with its outlook eastward towards lower Komia and the sea. On our right hand below the road, just above the little church of the Panagia, on the north valley slope, I picked up fragments of early sixth century pottery, among them being part of an amphora, having a stamped design, consisting of a frieze with the hinder part of a lion or panther, and possibly the front part of a man pursuing. Lower down, however, I picked up part of a tile belonging to a much later era with two letters, **ΑΘ**, reading from right to left, similar to one acquired by us in Melos* with the legend **ΑΘΗΝΑΙΩΝ** (Fig. 2). Altogether there was sufficient evidence to point to an early Greek settlement at upper Komia, and rather characteristically at some little distance from the sea, though with the exception of some obscure lines of polygonal-looking



FIG. 2.—INSCRIBED ROOF-TILE, FROM KASTRIANI, MELOS.

wall further down on the south slope of the valley, I could trace no signs of early Greek habitation corresponding to the evidence of tombs.

The valley in which upper Komia is situated does not go down straight to the sea at lower Komia. The river-bed turns to the left north-east, then east again between high, partly precipitous hills until it reaches the sea at the little bay of Tria Pigadia. At the point where the valley turns north-east one ascends what is now its south slope through pleasant gardens and orchards until at the top lower Komia appears below us as a kind of amphitheatre descending steeply to a stony little bay, and commanding one of the loveliest prospects of sea and islands in the whole Ægean. At the top to the left are the house and out-houses of the proprietor. As one ascends to these houses between the gardens one notices foundations of cemented wall,

* [The tile here represented is in the British School at Athens, and is one of a series of similar tiles brought to me in May, 1896, by a man named Andreas Georgios Tseronis; they were found in his field at Kastriani, about 1 metre below the level of the ground. They formed a pavement and were "surrounded with large stones"; at a short distance away there are large blocks of squared stones, which have evidently formed part of some building (cf. 'Eφ. 'Αρχ. 1896, p. 255).—C. S.]

crossing the road into the plots right and left, which are evidently late Roman. A large ancient cistern, having a marble mouth with waved fluting, still supplies the farm with water. On descending with Manoli, the proprietor, into the amphitheatre-like hollow, with its tufa cliffs and detritus of variegated clay, I found it terraced at intervals with the low foundations of Roman house-walls, and plentifully littered with fragments of Roman household ware. Looking towards these remains from the beach one sees that their lowest level presents a complete section stretching all along the little bay. The walls at the bottom next the sea had gradually become submerged in the soft tufa and clay deposits brought down by floods from above. High seas acting on the mass from below undermined the lower part of it in such a way that the upper edge must have fallen over and got gradually washed away, thus producing a section from six to twelve feet high with walls going along it or jutting out from it all along the beach. These walls are hardly ever more than 0.65 m. thick; they are built everywhere of rather small white tufa and greenish-grey poros-like blocks from the mill-stone quarries, and nowhere does marble appear. They all seem to be perfectly uniform in structure and to belong to the same late Roman era. On the rising ground further south the proprietor pointed out the remains of tombs with fragments of pottery entirely in keeping with the ruins. There was nothing to suggest anything more than very ordinary burials, and all that could be seen was marked out as belonging to one short epoch. Altogether lower Komia suggests an emporium quickly called into existence, like others in Melos, for the convenience of Roman trade exploiting the mineral and other treasures of the island from without. When the imperial power passed away which could command trade on such a scale from without, those places suddenly lost their importance, and accordingly we find nothing on such sites in Melos to suggest Byzantine or mediæval occupation. On ascending to the farm-house and going beyond it northwards I found the lines of wall continue until I descended again to the bay of Tria Pigadia. On the beach here are to be seen exactly similar walls, also partly in section, among these being the apse-like remains of a potter's oven with the inner cemented face, towards the sea, blackened through the action of fire. These remains probably represent what was merely a suburb of Komia, which may have owed its origin to the existence of sulphur

mines near at hand up the valley. At Tria Pigadia begins a region of white flint that stretches all the way to Phylakopi, explaining the origin of the white flint implements occurring on the pre-historic site there. A characteristic feature of this flint region is the bay of Boudia further north and due south-east from Phylakopi. It has a lovely wide beach formed entirely of gleaming white flint pebbles. Similar pebbles, chipped to give a sharp edge for striking fire, I found in large numbers in the pre-historic town of Phylakopi. I picked up specimens at Boudia and at Phylakopi which were curious through having exactly similar natural holes through them.

Still more interesting, in a pre-historic connection, is the hill region south of Komia. Up the hill slope, just beyond the spot where the proprietor had shown me traces of tombs, black obsidian lumps and chips begin to make their appearance. Surmising from the analogy of the obsidian quarry at 'sta Nychia, above Adamanta, that the sources of obsidian here must be on the hill tops, I ascended these and found the whole hill country of Demenegaki, beginning immediately south of Komia and extending almost to above the steep, rounded valley of Revma, one large quarry of obsidian, the hollows being literally strewn with obsidian lumps and chips. The lumps strewn about had got loosened from the hillsides or been thrown away as bad specimens in the pre-historic times when those quarries were worked. I verified here the observation I had made at 'sta Nychia, namely, that the obsidian chips were to be accounted for only on the supposition that the quarries were also pre-historic workshops where obsidian implements were made on the spot. I brought to Athens specimens of lump obsidian from the site, and also obsidian implements or chips struck from such blocks. The endeavour to obtain arrow-head or knife forms is quite apparent in these chips. A large proportion, however, apparently consists of outside chips struck from the lump in order to get them into shape for striking off the implements, and of imperfect specimens rejected by the obsidian worker. All the good examples would be taken away. The discovery of this obsidian site provides us with a much nearer source of supply for Phylakopi than the one at 'sta Nychia, near the site of ancient Melos. It is remarkable, however, that the rough and primitive-looking implements found at the quarries are hardly noticeable at Phylakopi, and that the refined and

keen-edged implements and finely-chipped cores found in such large quantities at Phylakopi do not seem to exist on the quarry sites. These finely-chipped cores prove that obsidian implements were manufactured at Phylakopi itself, the cores found being such as were thrown away when they had become too small to produce implements of the size required. Specimens of these implements, from Phylakopi, with the kind of core from which they were struck off, are at the School in Athens, and it is interesting to compare them with the ones from the quarries previously shown. The production of such fine implements succeeding the primitive ones of the quarries certainly represents a stage of development in which increased skill is coincident with manufacture at the pre-historic settlement instead of at the quarries. It is possible that when the art advanced so far as to produce such fine work, the obsidian lumps, chipped and prepared for working, were conveyed to the site where they were used, to obviate the many chances of breakage which would be involved in transporting the delicate implements themselves in large numbers. The primitive workman of the quarries is supplanted by the skilled obsidian worker of the pre-historic citadel in a way which seems at first sight to correspond with the somewhat abrupt transition from pre-Mycenæan to Mycenæan civilisation. One purely pre-Mycenæan site which I had the good luck to discover, and of which I shall speak later, has yielded obsidian implements showing a complete analogy with the primitive ones of the quarries. But also the perfected obsidian implements found by us in large numbers at Phylakopi, equally belong to the pre-historic stratum, and in one case hastily-built Mycenæan walls went right over the obsidian heaps. In pre-historic burying places examined by me in Naxos and Ios perfected obsidian implements were found along with pre-historic marble idols of the Amorgan type. Both the quarries of Melos must have supplied Phylakopi with obsidian, but they are of such vast extent and have been worked on so great a scale that there must have been a large export traffic as well. Phylakopi in its era of pre-Mycenæan prosperity must have commanded this trade and possibly even supplied other islands with ready-made implements. But it would be further interesting to verify the making of fine obsidian implements like those of Phylakopi at other sites in islands not possessing obsidian, because it would probably be found that the quarries of Melos

supplied such islands with obsidian in the lump. None of the islands adjacent to Melos explored by me—Pholegandros, Kimolos, Siphnos, Seriphos, Paros, Antiparos, Naxos, Ios, Sikinos, Thera — possess obsidian in the natural state.*

Palæochori and Hagia Kyriaki on the south-east coast of Melos, and about the same distance from Trypete as Komia, exhibit the same features in their visible remains as the latter site. The two places occupy the shores of adjoining bays separated by the hill of Lulo and the headland of Pyrumeni.

At Palæochori the land slopes down gradually on the right, more steeply on the left, from the surrounding hills to the shore. Fragments of late Roman household pottery, like those of Komia, strew the ground rather plentifully at parts, but it is only on coming quite near the shore that one notices any very evident signs of ancient habitation. Lines of wall come in sight in the fields here and there, but on coming towards the shore where the level of the soil is highest to the right, one is brought suddenly to a standstill by a perpendicular fall of the soil, like that at Komia, presenting faces and projections of wall in section. The sea has here encroached in the same way as at Komia, only the foundations of the walls are at a much higher level than there. The tomb region occupies the rising ground to the right. All those noticed had been opened and consisted either of simple rectangular beds dug into the hill slope, as at Komia, or of square chambers, with small ante-chambers, cut into boulders of reddish rock. Some of the latter presented a strange topsy-turvy appearance through the boulders into which they had been hewn having got detached from the hillside. Walls, tombs and pottery fragments all point to the same late Roman era as at Komia, only at Palæochori nothing was noticeable further inland to point to an earlier Greek settlement like that of which there is evidence at upper Komia.

Beyond the hill-range to the west of Palæochori, in a valley of soft tufa, ledging sand-deposit and clayey sub-soil, worn away into innumerable deep, narrow channels by the action of winter floods, lies the site of H. Kyriaki. The two-year-old church which gives its name to the valley, stands on an eminence across it; the older church, seen by Ross,

* I have also learned from different sources that obsidian is not a product of Crete; a fact which greatly enhances the importance of Melos in pre-historic times.

lies in ruins at the top of the valley. Ross notices the evidence of Roman tombs near the church cut into the soft tufa, but did not get near enough to the shore to notice the rather extensive remains of walls. They everywhere occupy the summits of the knolls formed by the channels already referred to. The knolls dwindle towards the shore, and there is no section of walls, as at Komia and Palæochori, though the remains take up the whole breadth of the valley at different levels. In one of the deep channels a short distance inland from the shore I was shown the topmost of a series of forty subterranean steps which were excavated some years ago by a private speculator, who however failed to reach any foundation. Near the beach, and not many feet above the level of the sea, the proprietor pointed out the foundations of a large square building of one room, which he called an apothekè, or store, explaining that a large one-roomed building of that kind could hardly be a house. This rather acute observation bore out completely my own conclusions as to the commercial nature of the place. H. Kyriaki and Palæochori present exactly the same features as Komia, and belong to the same late Roman era. They are all emporia for the Roman exploitation of the mineral wealth of East and South Melos, and we know that the mill-stone quarries of Melos lie in the hill region north-east of Palæochori.

Crossing the long tufa ridge of Traphopés, west of H. Kyriaki, one gets into the knolly vineyard region of Vunalia, and after an hour one reaches the district of Provata, just where the island is narrowest. Here, on rising ground overlooking the south coast, are remains of a Roman villa with mosaic. In a field at the foot of the north slope of this hill I observed, on a second visit, numerous fragments of obsidian and of primitive-looking pottery, which seem to show that a settlement existed here in pre-historic times, though no walls are now visible. On the south slope of the same hill several fragments of stamped earthenware friezes of the sixth century B.C. (fragments of pithoi with reliefs) have been unearthed by the proprietor. The twin churches an hour further on, at Kepos, are described in a paper on the churches of Melos, by Messrs. Fletcher and Kitson (*Brit. School Annual*, *id.*, p. 155). At the farm-house above Kepos are numerous blocks from some Roman building. I penetrated further westward into the wild coast region south of the peak of Prophet Elias, but came upon nothing ancient

worth recording. The mountainous country gets ever wilder and more solitary, until from one of the ridges that slope south-westward from Prophet Elias, the west coast becomes visible, and the pilgrim church of St. John the Theologian, with its white walls, gleams below on rising ground in the distance near the sea.

The peninsula of West Melos, called 'sta Chalaka, is so wild and mountainous in its general character that it has been hitherto more assumed than known to be without ancient remains. Three features have, however, to be borne in mind which lead one *a priori* to expect such remains. Wild, pastoral country, with abundant hunting on the mountains, would be the chief attraction to a primitive people. The fertile valley districts would be certain to be sought out by a robust farming community like the ancient Melians. The mineral wealth of West Melos was sure to be appropriated for exploitation by the Romans.

From the landing stage at Emporio, across the bay of Melos, to the church and valley district of St. Helen's, is a two-hours' ride in a westerly direction; to the pilgrim church of St. John the Theologian, a three-hours' ride in a south-westerly direction through wild, mountainous country. For the first part of the way the road to St. John's and to St. Helen's are the same, the road to St. John's, after an hour-and-a-half's ride, branching south-west, the road to St. Helen's keeping west. An exploration of the confined valley district, in which St. John's is situated, revealed no trace of ancient remains. The marble lintel of the south door of the church, which had attracted my attention on a previous visit, has palmettes exactly like those on architrave blocks at the theatre of Melos, only of smaller size, and this piece of ancient marble may perhaps be best explained as having been transported from the theatre. There is nothing near at hand to account for it.

After having returned from St. John's to where the road branches, I arrived at St. Helen's in less than an hour's time. The outlook of the district is westward towards the sea, and it occupies a wide valley region lying between the mountain-range which stretches westward from Mount Elias to the sea on the south, and the lower range of Triavouná on the north. Lateral spurs project north and south from these main ranges into the valley, forming the watersheds for numerous winter torrents which unite into three main river-beds running westward

to the sea. On the largest of these spurs, projecting northward into the valley, the church and site of St. Helen's are situated. The roomy plateau which forms the top of this spur sinks with gradual undulations towards the north, and commands a magnificent view westward of the sea, which is half-an-hour's walk distant, with Erimomelos standing out to the right. On this plateau the proprietor, Jannis Kranitzas, and his father showed us considerable remains of walls running in their greatest length, like the plateau itself, north and south, and built of very large quadrate blocks of grey, poros-like stone quarried from the hillside further down. The system of walls—though these rise sometimes to a height of 3 or 4 feet—is very difficult to trace, owing to the dense covering of brushwood which has overgrown the place. The solid workmanship of the closely-fitting squared blocks, showing very little filling-in and no cement, made, at first sight, the impression of a Greek building of Hellenistic date. The outsides of the blocks are left rough, and the outside corner-stones have their angles set back in the same way as the corner-stones of the theatre at Melos. This peculiar manner of dressing the outsides of wall blocks is never earlier than Hellenistic, and continues down into Roman and later times. With considerable difficulty I was able to make out the foundations of as many as ten rooms of different sizes, the largest measuring 16 m. by 8 m. This chamber had the other rooms adjoining its east and west walls, but its south-east and north-west angles must have been visible, for they had the peculiar working referred to above. Outside the south wall of this chamber there seemed to be a free space 8 metres wide, beyond which the lines of wall began again, the furthest wall visible being 65 metres distant in the adjoining vineyard. The rooms adjoining the east long wall of the large chamber referred to extended northward for a distance of nearly 18 metres. The building was undoubtedly a large villa, with outhouses attached to it. The uncemented walls might be considered in themselves to point to late Greek times, were it not that no fragment of any kind of Greek pottery was discoverable anywhere near the site. On the other hand, fragments of ordinary late Roman ware were abundant. Pieces of what I took to be Roman tile were found in the field adjoining the ruins to the east, and also two very large cakes of cement. These finds point to a Roman rather than a late Greek villa.

About 30 metres north of these walls is situated the little church of

St. Helen's, and from below its north wall project, at right angles, the foundations of an anta-like wall, with the base of a column in position beside it. This wall and column-base seem much earlier than the other large building. Whatever the building of which it formed a part may have been, its entrance must have been to the north, instead of to the east, as one would ordinarily expect for a temple, yet the existence of a Christian church on the site speaks for the sacred character of the older building. Some metres further on, and a little to the left, appears part of another wall of massive polygonal-looking stones, beyond which no further remains are visible.

In the opposite direction, south-east of this site, at the foot of the hills, the proprietor's father showed me, just behind his house, a rectangular building, 10 metres by 4 metres, with a low, apse-like construction projecting from the east end of its south wall. The walls, of unsquared stone, are 0.70 m. thick, and, so far as one can see, uncemented. The apse is too low, and is not in the right position for either bath or church, and my informant was probably right in explaining it as a potter's oven, with adjoining workshop. Further down the valley I was shown seven empty tombs, two of them rather extensive, cut into the rock, of the usual late Melian shape.

Descending, in a northerly direction, the plateau on which St. Helen's stands, one comes to a river-bed. After crossing this, one ascends some distance, and so reaches the summit of an elevation dividing the first from a second river-bed. Shortly before reaching the brink of this second river-bed one emerges on the topmost of a series of five semi-circular terraces, sloping down towards the channel. These terraces are strewn with primitive Greek pottery, belonging to the earliest post-Mycenæan times and indicating a necropolis belonging to an early Doric settlement here near the west coast of the island opposite the Peloponnesian mainland. That the post-Mycenæan Dorians, who settled ultimately on the site of ancient Melos, should approach the island from the west is as natural as that the pre-Mycenæan people, of Phylakopi, should approach it from the north-east. Into the topmost terrace an Italian mining company, in search of drinking water, had sunk a shaft some seven or eight metres deep, showing solid rock all the way down. If the tombs indicated by the fragments of pottery strewn about were hewn into the face of this

rock, there is a chance that some of them may be unopened. On this side of the river-bed there appeared no walls corresponding to such a necropolis; but on the opposite bank the proprietor, Jannis Matheudakis, showed us rows of rough sandstone or poros blocks edging his fields, which he said he had dug from walls a few feet down. These stones may very well have belonged to human habitations, corresponding to the necropolis described. The proprietor, who was curiously quite unaware of the existence of this burying place, showed us, with some pride, the remains of late Roman tombs further up the valley in the direction of important bismuth mines. If those mines were worked in Roman times, these quite inferior tombs may have been connected with them.

Going in the same direction northward, over the Triavouná range of hills which bounds the St. Helen's valley on the north, we come, in an hour and a-half, to Angathia. We have here an upland valley with its outlook westward like that at St. Helen's, but with a much less open prospect towards the sea. On rising ground on the north slope of the valley opposite the proprietor's house is a system of wall foundations divided into squares, which mark the building as some ancient house. A cemented pebble mosaic, as well as most of the pottery strewn about, offers evidence for assigning it to Roman times. But there were also some fragments of early Greek pottery to suggest that the site must have been occupied in early Greek times. The walls are not nearly of the same solid character as at St. Helen's, and the building makes more the impression of a Roman farm-house than of a Roman villa.

Half-an-hour's walk in a westerly direction, through rough country, brings us to the stony little bay of Bourlidia. Taking the left side of the bay and ascending a little, we come upon the site of 'sta Glastriá, so-called from the fragments of late Roman pottery strewn about. A large square tomb with a second smaller chamber to the right of the entrance, was quite littered with fragments of pottery of exactly the same character as at Komia, Palæochori, and H. Kyriaki. We discovered no corresponding ruins near at hand, but the headland, on which the Roman settlement suggested by this pottery probably stood, has been gradually washed away by the sea, forming now a large square-shaped bay with soft-ground rock everywhere. Such a late Roman settlement in this wild pastoral country can hardly be

explained, except in connection with the mines of West Melos. It and the similar settlements in East Melos are best referred to the Hadrianic era of Roman prosperity which saw the building of the extensive harbour works, as well as the theatre and other important monuments in Melos.

At the north end of the bay of Bourlidia is a steep bank of clay descending to the water's edge, where fragments of late ware again indicate the site of Roman tombs. Immediately above, the remains of two pre-polygonal-looking walls, parallel to each other and to the north shore of the bay, make their appearance. The first was about twelve metres distant from the sea, the second twenty-eight metres from the first. These walls cannot possibly be connected with the tombs which have to be referred to the site of 'sta Glastriá. The primitive character of the walls seemed to be borne out by the fact that very rude obsidian implements began to make their appearance at the same time. Through inquiries and journeys in different directions, I am able to certify that black obsidian in the natural state does not exist in West Melos, so that the obsidian fragments referred to are not to be regarded as natural chips. We ascended the hill in the same northerly direction and began to descend on the other side. Here, extended along the hill slope, in an easterly and westerly direction, stand three exactly similar walls, at the same interval from each other as the previously noticed ones, and built in the same pre-polygonal manner of the same reddish brown stone, with smaller stones filling in interstices. They could be traced rising a foot or so above the surface for about forty or fifty metres of their length. The upper two were connected at the end away from the sea by a similar cross wall. I could come to no conclusion as to what they had been intended for, but their pre-historic character seemed to be borne out by the large size of the stones, their primitive pre-polygonal masonry, exactly resembling that of the strong walls at Phylakopi, and by the presence, though to a limited extent, of obsidian implements in the neighbourhood. I was afterwards confirmed in this opinion by the discovery in North Siphnos, on a hill-slope looking northward towards the peninsula of Chersonese, of a similar system of eighteen walls, parallel to each other, and from 10 to 18 metres apart. Here also I observed fragments of pottery and of obsidian implements of a very primitive kind.

We next descend, in a northerly direction, to the little sandy bay of Tria Pigadia, bounded on the north by the hill and promontory of 'sta

Samari. Having surmounted the crest of the hill, we perceive on the north slope of it, below us, a kind of terrace gently undulating into the level ground further on, and almost entirely covered with an overgrowth of brushwood. On coming on to the terrace we observe, so far as the overgrowth of brushwood allows us, a system of very primitive-looking walls, with cross-walls at irregular intervals running in their greatest length east and west. It is a peculiarity of such very primitive pre-historic walls, that in themselves they can hardly be distinguished from rude modern walls not more than a century or two old.

The pre-historic character of these walls was established beyond doubt only by the coincidence, on the same site, of other very characteristic features. The fragments of obsidian implements were found over a considerable area all round, the quantity decreasing with distance from the site. Fragments of very primitive, entirely unpainted and unvarnished pottery were to be picked up over the same area as the obsidian, but most plentifully on the site itself. It could not be said that either pottery or obsidian was exactly abundant, but the surface is everywhere undisturbed and covered with mountain vegetation and its deposit, and even at Phylakopi very little obsidian or pottery was noticeable on the surface where the ground had not fallen away or been excavated. While considering whether I had really sufficient evidence to point to a pre-historic site, I had the good luck to discover, near one of the walls, one of those very primitive household stone utensils which Schliemann, *Ilios*, p. 234, calls saddle querns, and one of which, exactly similar, I had myself excavated in the very lowest stratum at Phylakopi.

In the summer of 1897 I came upon evidence of pre-historic settlements in Pholegandros, Siphnos, Paros, Antiparos, and Naxos, but the one at Samari, owing probably to its distance from cultivated land, was much better preserved than any of them. So far as could be judged, they were all, like Samari, open and unfortified, and built in very primitive fashion of rather small stones, which in the case of those settlements near land now under cultivation, are apt to be taken away for the construction of field dykes. In this way whole sites tend to become obliterated, and it is quite possible that also at Pelos the settlement corresponding to the tombs may have thus disappeared. Similarly in Paros a large number of pre-historic cemeteries examined by me showed no trace of any corresponding human habitation.

On the other hand, in south-west Paros, I came upon what must have been an extensive, but now partially obliterated, settlement near cultivated land, but, just as in the case of Samari, I failed to find any evidence of burial near. It thus becomes all the more important to record instances such as I found* in Pholegandros, Siphnos, and Naxos, where the existence is indicated of pre-historic settlement and burial-place side by side.

The chief interest of the site is its very primitive, purely pre-Mycenæan character. The stones forming the walls are relatively small and entirely unworked. There is no trace of strong walls visible. The obsidian implements are much ruder than the typical ones from Phylakopi, with their high finish of workmanship, and correspond exactly with the much more primitive ones of the obsidian quarries. The pottery fragments show a very rough grain, with a surface occasionally hand-polished, but no trace of glaze or paint. Everything points to a very rude pre-Mycenæan settlement, corresponding to the earliest settlements represented in the lowest strata of Hissarlik, and with no trace of the rich Mycenæan culture which at Phylakopi submerged the earlier island civilisation.

Dr. Cecil Smith has pointed out how proximity to Kimolos and the chain of the Cyclades probably determined for its pre-Mycenæan inhabitants the site at Phylakopi. But how are we to explain a pre-Mycenæan site on the west coast of Melos, facing the open sea, with the Peloponnesian coast barely visible on very clear days? We can conceive Dorians or even Mycenæans landing here from the mainland, but not so easily the pre-Mycenæan people pre-supposed by our site. The most natural solution is that this is an offshoot from Phylakopi, contemporary with, or immediately following, the first landing of the earliest pre-Mycenæan people, of which we have evidence there, and at any rate long prior to the Mycenæan invasion. This simple organic process of separation is part of the life of a primitive people, but the further destiny of the detached members depends on the environment they have chosen to settle down in, and the wild isolation of West Melos was against prolonged or very prosperous life. The settlement at Samari died a natural death long before the first Mycenæans and their culture took possession of Phylakopi. But the existence of such very primitive pre-Mycenæan settlements anywhere throughout the Ægean Islands or

* The results of this journey will be published later.

elsewhere deserves, quite apart from the prospects of excavation, to be put on record, because the absence of any later influence in such cases secures us an isolation of the phenomena which clears our conceptions of earlier in relation to later in the study of these pre-historic civilisations.

On my return to Trypete after having verified a pre-Mycenæan settlement in West Melos, I thought it all the more improbable, considering also the proximity of the large obsidian quarry of 'sta Nychia, that there should not turn out to be some evidence of a similar settlement somewhere about the site of ancient Melos. The situation that seemed to me most likely was a high terrace north-east of Tramythià, lying at the foot of the lofty cliffs and precipices just below Plaka and Kastro in a westerly direction. Here, among huge boulders of reddish rock that had fallen from the precipices above, I could actually trace here and there obscure indications of rude walls of the same stone as the boulders. There was, however, so very little visible of those walls that no conclusion could have been drawn from them, were it not for the presence here also of obsidian chips and fragments of rude, coarse-grained, unpainted pottery exactly like those of Samari. There was nothing further than would just point to a small pre-Mycenæan settlement with, like Samari, no trace of anything actually Mycenæan, and, like Samari, to be explained as part of a westward movement from the earliest settlement of which we have evidence at Phylakopi.

On the other hand, after we had already made up our minds that there was no evidence of anything Mycenæan on the site of ancient Melos, it surprised us to find, on the east slope of the little west acropolis of the ancient city, along with pottery of much later date, occasional fragments of painted Mycenæan ware. If this acropolis should come to be excavated it will be interesting to observe what further evidence in the same direction will result.

In bringing this record of ancient sites in Melos to a close, it may, as an indication of how much remains to be done in other islands of the Ægean, be remarked that not one of the ancient sites in West Melos, including the pre-Mycenæan Samari, has been hitherto so much as suspected. And the same is true of the pre-historic burying place at Pelos, and the pre-historic obsidian site beyond Komia, in East Melos.

DUNCAN MACKENZIE.



COIN TYPE OF ELIS, RESTORED.

THE IONIC CAPITAL OF THE GYMNASIUM OF KYNOSARGES.

(PLATES VI.—VIII.)

THE excavations of the British School at Athens, in the winters of 1896 and 1897, had the result of determining that the site, on which they were carried on, had been a burial ground previous to the sixth century B.C. and again after the third century, and that, in the meantime, it must have been covered by the Greek building, of which we laid bare the foundations. The plan of this building resembles that of a large gymnasium; the period of its existence coincides with that during which we know the gymnasium of Kynosarges to have existed, and the position of the site is such as the various mentions of Kynosarges by classic authors leads us to expect. We therefore claim to have determined the site of the gymnasium of Kynosarges; and such of its architectural remains as we hoped to find would naturally fulfil two conditions:—that of belonging to a date within the two limits of the existence of the gymnasium, and that of bearing some analogy to the details of similar gymnasia. We learn, however, from Livy XXXI., 24, that the whole Kynosarges quarter, as well as the Lykeion, was completely destroyed by Philip V. of Macedon, no building, whether sacred or domestic, having escaped his fury. We could, therefore, hope to find but little besides the foundation walls, and, in fact, a few terracotta antefixae and a fragment, slightly less than a quarter of an Ionic capital, were the only architectural remains found on the site, which, as far as their age is concerned, are likely to have belonged to the gymna-

siam. In temples the antifixae were, like the roof tiles, usually of marble; in less monumental buildings, such as gymnasia, it is natural that both should be formed of terra-cotta. The capital I will now discuss more fully.

A white marble fragment had been noticed for some time built into the limestone wall of one of the buildings of Roman date, which had been erected on the site of the former gymnasium. Its position is definitely marked on the plan of the excavations, which will shortly appear with Mr. Cecil Smith's article on the subject in the *Journal of Hellenic Studies*. On picking away some of the mortar in which it was embedded, it was seen that the fragment was a piece of an Ionic capital built in, lying on its abacus, with the volute inside the wall. We then had it taken out of the wall, and found the beautiful fragment shown on Plate VI. The line of the fracture across the underside and two fronts of the capital, is shown by a dotted line. The surface is smooth, without any existing trace of the painted ornaments which it doubtless had; only the scamillus on the abacus was left purposely rough. The volute is damaged along its lower rim for the distance of about a quadrant.

It was an easy matter, by completing the circle of the capital and drawing the other volutes and halves of cushions in their corresponding positions, to produce an almost complete drawing of the capital. The projection of the abacus over the cushions is given by the remains of the fillet between cushion and abacus. The only features, for the restoration of which the analogy of other examples had to be sought, were the mouldings of the cushions. At the fracture across the cushions are the remains of a bead moulding. As this is not on the centre-line of the cushion, it follows that there were at least two such beads. Still, two beads alone interrupting the curve of the cushion are not met with till Roman times, such as occur, for example, in the aqueduct of Hadrian, published by Stuart [see also Puchstein, *Das Ionische Kapitell*, pp. 22-3] and the temple of Apollo Chresterios [Bohn and Schuchhardt, *Altertümer von Aegae*, Plate 57], the latter of which dates from 46 B.C. To find an analogy for filling in the space between them, I did not have so far to go; for at the east end of the skenè of the Theatre of Dionysos in Athens, I found the capital shown on Plate VII. I will call this capital No. 2, and our fragment No. 1.

This second capital bears such a striking resemblance in all essential features to No. 1, that I did not hesitate to restore the mouldings of the cushion as the same, namely, three beads separated by fillets from two channels. A comparison of the proportions of one capital to those of the other leads me to think that No. 2, which is evidently the later, was copied directly from No. 1, or from some unknown example which served as model for both. Among the important dimensions of the front, the one in which the greatest difference occurs is the clear breadth between the volutes. In No. 1, this dimension is 0.422 of the circle on the under side of the capital, while in No. 2 it is 0.47, making a difference of 0.048, which after all is little. There is only one difference of design in the two capitals; on the sides the abacus is separated from the cushion by a fillet in No. 1, but by a flat ogee moulding in No. 2. This is an unimportant feature. Further, the two leaves at the junction of the volutes with the lower connecting fillet are of a less severe design in the later example. In this feature the sculptor of the capital would naturally allow his own invention greater liberty than in the essential proportions of the design. As to the origin of the Ionic capital, which I call No. 2, nothing is known. Dr. Dörpfeld assigns to it no place in his architectural restoration of the theatre, and he suggested to me that it may have been thrown over the edge of the Acropolis with the loose earth, which was cleared off that part of the Acropolis immediately above the theatre. This is not so unlikely as it at first may appear to those who have not had practical experience of excavations. In fact, it seems to be a not uncommon occurrence. For when the Greek Archæological Society last year excavated the northern slope of the Acropolis, a small Byzantine church was unearthed, which had some years ago been ruined by the pressure of the mass of earth thrown over from that part of the Acropolis immediately above it, on which the Erechtheion stands, and, as in the case of our Ionic capital, there were found, in and near the church, a Byzantine anta-capital, the cornice of an iconostasis, fragments of sculptured slabs, &c., which from their style cannot have belonged to the small church, but may be ascribed to the early Byzantine church fitted up in the Erechtheion. Near the bastion at the north-east angle of the Acropolis, called the "Belvedere," there have been collected a great store of Ionic capitals of a large variety of styles and sizes found on the Acropolis; but I saw none like No. 1 or No. 2 among them. In the

theatre, however, I found the upper end of a shaft and a base, which apparently belong to capital No. 2, and which had evidently been placed near it by some one who arranged the fragments there. I have drawn the section of these with the capital.

In my search for other examples of Ionic capitals of the same type as the two I am publishing, I did not find that one which was published by J. C. Watt, in 1893, in his *Examples of Greek and Pompeian Decorative Work*, Plate 30. This apparently he found "near the Acropolis." It varies but slightly from No. 2. Its total breadth is greater than, and its total height equal to that of No. 2, so that it works out as of flatter proportion. The centre of the eye is at exactly the same depth from the under edge of the abacus, but nearer to the bed-joint of the capital; the cymatium of the abacus is slightly higher than that of No. 2, but the cymatia between the volutes are equal, so that the channel connecting the volutes is slightly flatter than in No. 2; on the other hand, its downward curve has the same defect of abruptness. The spiral of the volute frees itself from the fillet round the eye a little sooner, and races a curve which deviates from that of No. 2, first inside and then outside, up to the point where the connecting fillet branches off; from there, for the last convolution, the curve takes a wider sweep, till it finally runs in under the abacus at the same height again as in No. 2. The junction here of the spiral with the horizontal line of the abacus is drawn by Watt in a way which is contradicted by his drawing of the side elevation of the capital, and which I think cannot be quite correct. The angle-leaves and the moulding under the abacus at the side, which are the two features where No. 1 and No. 2 differ, again show a difference, though less slight, the latter being a more inclined ogee than that of No. 2. There is one important innovation in Watt's capital in the curves of the cushions. These, instead of terminating in trumpet-shaped curves, have graceful bell shapes. The upright mouldings between these two bells are another precedent for my restoration of those of No. 1.

There is yet a fourth capital of this type existing in Athens. It is that of the Ionic colonnade near the monument of Lysicrates, published by Stuart in vol. iii., chap. xi. It is a further development of the three capitals just described. In the front the point of difference, which is noticed at once, is the absence of the lower connecting fillet between

the two volutes. On the sides the cushions have trumpet-shaped curves as in Nos. 1 and 2, and are separated from the abacus by a fillet as in No. 1; but the mouldings between the two trumpet-ends are four beads instead of three, and the cushion starts direct from the horizontal fillet, not from a chamfer under it, as in the other three examples. Stuart says of this colonnade: "Though it is not possible to discover what this building was, it is undoubtedly part of a considerable edifice." No doubt he was led to this conclusion by the size of the capitals rather than by their style; for he also says: "The workmanship is very rude and unfinished, from which circumstance they were, probably, never intended to be much exposed to sight." In fact, on comparing his drawing of the capital with the original, it is evident that he has represented his idea of how the capital should have been carried out, rather than how it actually is. An Ionic capital found in the Hall of the Dionysiastae, at Piraeus, dating from the second century B.C., is a fifth Attic example of this type (Puchstein, *Das Ionische Kapitell*, p. 34).

Now it is evident, that these four Athenian capitals—from Kynosarges, from the theatre, Watt's capital and Stuart's—form a closely connected group. The better to show their resemblance I have made a comparative table of the proportions of the fronts:—If we take the diameter of the circle at the bottom of the echinus of each capital as the units for measurement, then—

	1. Kynosarges.	2. Theatre.	3. Watt.	4. Stuart.
Greatest breadth of abacus . . . =	1·02	1·072	1·138	1·09
Breadth across volutes . . . =	1·487	1·468	1·41	1·505
„ between volutes . . . =	0·422	0·470	0·452	0·49
„ of each volute . . . =	0·532	0·499	0·506	0·51
Height „ „ . . . =	0·589	0·571	0·563	0·58
„ of capital . . . =	0·4375	0·419	0·416	0·42
„ of centre of eye from joint =	0·0225	0·035	0·034	0·038

The units of the four capitals are 0·773, 0·94, 0·95, and 1·625 of one foot respectively. We can therefore consider capitals 2 and 3 as duplicates with slight variations. Also, from a comparison of their style of execution, it is difficult to determine any difference in their age. There

is, however, no doubt that Stuart's capital is the latest of these four, and the Kynosarges fragment the earliest and best.

Some of the superiorities of the design of No. 1 are worth pointing out, as they may be missed on my drawing, owing to its necessary reduction in the Plate. The front is at once placed on a higher level by the graceful curve of the lower connecting fillet between the volutes, which is very abrupt in the next two capitals. Another point of superiority is the graduation and strength of the fillets forming the volutes and the connecting channel. It is mainly through omitting to add sufficiently to the breadth of the fillet of the volutes, in order to receive the junction of the lower connecting fillet, that the designer has been obliged to give such an abrupt curve to the latter; also the thinness and lack of graduation of the fillets gives to the later examples a mean worm-like appearance. In the Kynosarges fragment, not even the fillet under the abacus is left ungraduated—this is the only refinement of design found in the theatre capital—and the most remarkable example of refinement is to be seen in the graduation of the fillet encircling the boss of the eye; the outer edge of this fillet gradually approaches the boss, thus, as it were, carrying on the spiral of the volute for another convolution. At this point Watt's capital shows a superiority over the theatre capital; for, though the fillet round the eye has not got the graduation of No. 1, it has not got the unexpected and clumsy breadth of No. 2. The section across the capitals shows that the cymatia, though of bolder projection, have finer curves; on the other hand, the eyes and angle-leaves are kept flatter, thus avoiding the rather bulging appearance of the other examples. On the side of the capitals, that part of the cushion of our fragment still preserved shows, like the front, a superiority over the other capitals. The curves of the trumpet-ends are not so abrupt as those of No. 2. Though I have the authority of two capitals for restoring the mouldings in the middle of the cushion as I have done, I found it difficult to give to this part of the design that same variety and subordination of one part to another which give such beauty to the front. Still, I have been able to improve on the design of No. 2; for if we join the curves of the trumpet ends of the cushions in a single ellipse-like curve it is seen that the two channels between the fillets of No. 2 cut in beyond this curve; in designing these channels for our fragment I have traced

their curves as only touching the continuation of the trumpet-shaped curves. Again, in the view of No. 2 from below, the faces of the four fillets are in a straight line, and the three beads project to an equal extent from this line. In this case I think I have given a refinement to the Kynosarges capital by slightly recessing the face of the inner pair of fillets with the projection of the bead between them. It is certain that these beads and fillets stopped against that piece of the echinus which is visible under the cushions, whereas, in No. 2, owing to the entire suppression of the echinus, the ends of the beads have to be broken off in a very inartistic manner to make room for the top bead of the shaft. On the upper surface of our fragment is a scamillus, designed to protect the moulding of the abacus from the pressure of the architrave. This would also give a better appearance to the side of the capital by causing a sharp black line of shadow between the abacus and the architrave. Finally, as regards the spiral curve of the volutes, on which the merits of all Ionic capitals mainly depend, our fragment is clearly far superior to No. 2; but I have prepared a diagram, Plate VIII., which I will now explain, whereby the differences between the spirals are located, and can be more easily recognised than by eye-measurement.

From the centre of the eye marked C, a number of radii (in this case 16) are drawn at equal angles; the points of intersection of these radii with the spiral are numbered, and their distances from the centre C are marked consecutively on a series of straight lines drawn perpendicular to a line C C' at equal intervals. It is evident that the curve drawn through the ends of the series of perpendiculars moves away from the base line C C' with the same increase of distance as the spiral moves away from the centre C; and as it runs through a series of parallel lines, it is easier to mark the manner of this increase than in the spiral, which runs through a series of radiating lines. Compare, for instance, the curve thus constructed from the volute of the Kynosarges capital with that of the theatre capital. The systematic increase of the former, and uncertainty of the latter, are made clear at once. The increase of breadth of the spiral path between the convolutions of the volute is marked by the lower curve, which branches off at point 16 from the curve just described. To construct this lower curve it is necessary to set up the lengths of radii contained between two convolutions of

the spiral consecutively as before, but on the upper base-line RR' which is drawn parallel to CC' at a distance equal to CR , the radius of the eye. For the first convolution round the eye it is evident that the two curves will coincide. This curve shows very strikingly with what uncertainty the path of the volute of the theatre capital widens; in fact at one point (25) instead of widening it becomes narrower. The systematic undulations in the curve constructed from the Kynosarges volute need some explanation. Mr. Penrose has discovered a method of drawing the spiral of the Propylaea and Erechtheion, fully described in an appendix to his *Principles of Athenian Architecture*. As he claims mathematical accuracy for the spiral produced by his method, I have reproduced it here and subjected it to the same treatment as that applied to the volutes of our fragment and the theatre capital. It is clear, from the similarity of the undulating curves so constructed, that the volute of our fragment was constructed on the same principle as the volutes of the Propylaea and Erechtheion, whether that principle was perfected by mechanical methods or by the hand of the artist. From the method discovered by Mr. Penrose, it is clear that the centre of the spiral does not coincide with the centre of the eye, and this accounts for the undulations in the curve marking the expansion of the spiral. The great dissimilarity of the curve of the theatre capital shows that its designer was unacquainted with the method of the Propylaea and Erechtheion; and the similar capital published by J. C. Watt, in his *Examples of Greek and Pompeian Decorative Work*, shows hardly any improvement on it, though it has not got the definite fault of decreasing instead of increasing, which I have shown the theatre capital to have. Watt publishes two other volutes full size; one of these, on Plate 26 of his work, belongs to that capital which was found among the rubbish caused by the destruction of the Acropolis by Xerxes in 480 B.C., and was first published by R. Borrmann in *Antike Denkmäler*, Plate 29, No. 2. It has a beautiful spiral curve; but by determining the increase of the radii it is evident that it is constructed on an entirely different principle to the Propylaea, Erechtheion, and Kynosarges capitals. There is no undulation in the curve constructed from it, which shows that the centre of the spiral and the centre of the eye coincide; but the curve moves away from the base-line with an even ratio in the increase of distance, closely approaching that of a logarithmic curve. The spiral

of the volute therefore closely approaches to a logarithmic or equiangular spiral, with the centre of the eye for its centre.

These facts about the volute of our fragment, as compared with the volutes of examples of various periods, bear out the conclusion, to which we are led by the consideration of the other refinements of its design, that it belongs to the best period of Greek architecture.

Let us now consider Athenian Ionic capitals in general, in order to assign a place among them to the group formed by our fragment, the theatre capital, Watt's and Stuart's capitals. Puchstein, in his *Das Ionische Kapitell* (Winckelmannsfest, 1887), has made an excellent arrangement of the Ionic capitals then known. From him we learn that previous to 480 B.C. there was used in Athens a type of Ionic capitals dating back to the first half of the sixth century B.C., with somewhat varying characteristics, as represented by the examples numbered 2—9 in Puchstein's book, and four archaic capitals published in *Antike Denkmäler* I., Plates 18 and 29. The development of this type is suddenly interrupted by the perfected type created by the genius of Mnesicles in the Propylaea. This is imitated in the temple on the Ilissos and that of Nikè. A development of the type is already noticeable in the latter, and is carried still further in the two Propylaea at Eleusis. In Asia Minor the type was also developed in the capitals of the Mausoleum, the temple of Athena Polias at Prienè, of Artemis at Ephesus, the great altar at Pergamon, and the temple at Messa in Lesbos (see Koldewey, *Lesbos*, Plate 24), till the Vitruvian norm appears in the Didymaion in Olympia; this shows points of resemblance to the later Peloponnesian type, and finally dies out in the post-Vitruvian group of the temple of Dionysos at Teos, the Aedicula at Knidos, the votive columns of Ptolemy Philadelphos and Arsinoè at Olympia, the Propylon in Samothrace, and the temple of Cybelè at Sardis. Meanwhile in Athens itself the Mnesiclean type was in its turn supplanted by that of the Erechtheion, which was an importation of an old Ionic type represented in the temples of Apollo at Naucratis, of Hera at Samos, the temple at Lokri, the Nereid monument at Xanthos, and a capital at Palermo incompletely published by Hittorf; while in Athens it is imitated without further development in the temple of Roma and Augustus on the Acropolis, a capital now in the Berlin Museum belong-

ing to some shafts in the Stoa of Attalos II., and a half capital found in the Erechtheion.

Now, as Puchstein points out, the difference between the Mnesiclean type and the archaic capitals consists in the fact that the egg-and-dart band is sculptured, not painted, and the spiral of the volute is traced by mouldings, not a flat fillet. These are the very features in which it differs most strikingly from our fragment, and as the latter belongs to the period succeeding that of the archaic capitals, we cannot but infer that though another type was introduced in the Propylaea and carried on for a short time, the archaic type, so far from being altogether supplanted, continued to be developed through our fragment, the theatre capital, Watt's and Stuart's capitals, to the very end of Greek architecture.

Now Athens is not the only place where Ionic capitals with the uncarved cymatium and the flat fillet for the volutes prevail. At Olympia no other type seems ever to have been introduced. Puchstein shows how widely this type is distributed by quoting the capitals of the Propylaea at Palatitza; that of Apollonia, the temple of Jupiter, and so-called Basilica at Pompeii, probably also the capital of Dodona. Capitals of this type first appear in the Peloponnesus in the temple of Apollo at Phigaleia, and are further represented at the Heraion and entrance to the stadion at Olympia, at Megalopolis in the Stoa of Philip, discussed by R. W. Schultz in *Excavations at Megalopolis*, and the Stoa at Epidaurus. This is clearly an importation and development of the old Attic type; for we know from Pausanias that Iktinos, one of the architects of the Parthenon, was employed to design the temple at Phigaleia. The great difference from the old Attic type, pointed out by Puchstein, viz., that the centres of the eyes lie well within the lines of the shaft, is caused by the problem of designing a capital for the temple at Phigaleia, with volutes on the sides as well as the front. In the later examples it is merely a case of imitation. It is unfortunate that the Ionic capitals, which certainly crowned the four columns of the Opisthodomos of the Parthenon, are not preserved. In them no doubt Iktinos brought the old Attic type to its greatest perfection. Next appears the second and allied Peloponnesian group, which, as we learn from Puchstein, is first met with in the Philippeion in 338 B.C. This capital is very similar to that of the Ionic colonnade,

near the monument of Lysicrates in Athens, and though the date of the latter is unknown, the Philippeion type was probably derived from the Attic type represented by our fragment, just as the older Peloponnesian type was derived from the older Attic type as developed by Iktinos. In any case, whether there was any connection between these groups, or whether they were developed independently of each other, their similarity and constantly recurring appearance in all parts of Greece, at least prove the existence of a well-defined European type of Ionic capital, as opposed to the Asiatic type. It is also noticeable that the type with the uncarved cymatium and unmoulded volutes was never employed as the main exterior order of the finest buildings by the European Greeks. This dignity they reserved for the Doric order. When the Athenian Greeks designed their three small Ionic temples, the Nikè temple, the Ilissos temple, and the Erechtheion, they used those Ionic types which took the place of the Doric order in Asia Minor. Now this points to the probability that the Mnesiclean type is, like that of the Erechtheion, of Asiatic origin; and in that case we must absolutely reject Puchstein's theory, that the Ionic capitals of Asia Minor are developments of the Mnesiclean type; for, though the superiority of this type cannot be disputed, it is in the highest degree unlikely that the architects of Asia Minor, the very cradle of the Ionic Order, should go to Athens for a model for their capitals. Much rather must we look to Asia Minor for models copied or adapted by Mnesicles, and which were also followed by the later Asiatic architects. It is certainly a significant fact, that the type did not make its appearance in Athens till after many years of intercourse with the Asiatic Greeks, whereas as early as the sixth century, B.C., Ionic capitals with carved egg-and-dart were used at Samos and Naucratis. Till then the old Attic type with uncut egg-and-dart, was the only one used in Athens. When Puchstein wrote on Ionic capitals, no Asiatic example of a date previous to the reign of Alexander had been found. Nevertheless, from the Ionic capital of Cavalla, already then known, published by L. Heuzey and H. Daumet in their *Mission Archéologique de Macédoine*, we could form some idea of the type of capital used in the early Ionic temples, which served as models both for Mnesicles and the later Asiatic architects.

In the carving of its egg-and-dart ornament and the moulding of its

volute it resembles the Mnesiclean type ; but the number of the eggs is twenty instead of twenty-four, and the huge size of the volutes and the absence of an abacus are decidedly features of an earlier age. The supposition to which these many facts lead us, viz., that the Mnesiclean type is of Asiatic origin, has become a certainty since the discovery at Ephesus of various fragments of the Ionic capitals of the first Artemision dating from 560 B.C. The complete capital now in the British Museum, as restored from various fragments discovered by Wood, is published by Dr. Murray in the *Journal of the Royal Institute of British Architects*, vol. iii., 3rd series, Plate facing p. 52 and Fig. 9 on p. 53. It is needless here to repeat Dr. Murray's description accompanying these illustrations, or the parallels he adduces for the archaic arrangement of the egg-and-dart band and convex moulding of the channel of the volutes ; but to these may be added the archaic Attic capital published by R. Borrmann in *Antike Denkmäler*, i., Pl. 29, which has the same arrangement in its painted egg-like leaf-band on an uncarved cymatium of similar outline ; also the fact that the convex channel of the volutes is an essential feature of the "Aeolian" capitals of a slightly earlier period (owing to the fact that their volutes grow vertically out of the convex outline of the shaft), seems to confirm the theory held by Puchstein and Koldewey, that both the Ionic and Aeolian capitals are developed from a type in which the vertical and horizontal elements are fused, though from the entirely opposed principles of their construction they must be considered independent and diverging developments (cf. Puchstein, *Das Ionische Kapitell*, p. 56, and Koldewey, *Neandria* (Winckelmannsfest, 1891), p. 42).

Dr. Murray mentions several fragments not incorporated in the complete reconstructed capital, "which indicate different types of capitals on the same temple"; some of them he professes himself unable to explain ; but if he is referring to the fragments exhibited in the British Museum with the reconstructed capital, all the difficulties are cleared up by a comparison with the Cavalla capital. In this capital the central channel of the cushion is not allowed to run on to the cymatium underneath, but is stopped in a rounded end, round which is carried one of the two fillets and beads between the channels, the angle where the beads branch off being filled by a dart-

like leaf. This is exactly the treatment applied to all four channels of the cushion of that Ephesian fragment which retains vivid red colouring. In another fragment not only is the channel thus stopped just before reaching the cymatium, but the same treatment is repeated somewhat higher up the cushion, as if there were a shorter set of channels laid on those which are carried on to the cymatium; the small dart-like leaves are, however, omitted from the upper channel-ends. The presence of this feature in the Cavalla capital must now be considered another of its archaic features. The feature of greatest importance to us in the consideration of this capital is the position of the channel between the volutes directly on the cymatium, which is consequently partly covered by the palmettes. Seeing that this feature occurs in this very archaic capital as well as in the latest Greek examples, we may expect to find it also in some capitals of the intermediate best period. Unfortunately, in the historic continuity of the Asiatic type of Ionic capitals with the carved egg-and-dart band and the moulded volutes, there is a great gap between the old Ephesian capital and the next examples from Prienè and the Mausoleum, which are only slightly older than the later Ephesian capital; nor does the Mnesiclean capital of the Athenian Propylaea, which is of intermediate date, adequately fill the gap; for the cymatium is separated from the channel by a filling-in piece, in which the palmettes entirely rest. In this respect Mnesicles remained faithful to the traditions of some of the old Athenian stelè capitals (cf. Puchstein, *Das Ionische Kapitell*, Figs. 2—8). In those later Attic examples which took the Mnesiclean type for their model the tendency was to suppress this filling-in, and consequently to cover part of the cymatium with the palmettes (cf. Puchstein, *Das Ionische Kapitell*, Fig. 10—14). Durm, in his *Handbuch der Architektur*, Zweiter Theil, i., p. 257, goes so far as to say that, in the separation of the cymatium from the channel, Ionic capitals of the best period resemble the stelè capitals of the early period, and are thus to be distinguished from capitals of late periods. The fragment of the capital from the Heraion at Samos is insufficient for a conjecture as to the relative position between the channel and the cymatium, but Puchstein is probably right in arguing, from the joint above the cymatium, that it belongs to a quite distinct group which is represented at Athens in the Erechtheion, though with richer mouldings in the

volute [cf. *Antiquities of Ionia*, vol. i., part 2, chap. v., Plate 3, and Puchstein, *Das Ionische Kapitell*, p. 28]. But even before the discovery of the old Ephesian capital we knew of examples which are exceptions to the classification made by Durm. Such, for instance, is the Cavalla capital.

Again, one of the stelè capitals on the Acropolis at Athens, made of poros stone, and therefore the oldest of all (No. 9 in Puchstein), has the very features which are supposed to mark a capital as a late one. Puchstein places it not later than the middle of the sixth century; perhaps this is even too late; for its features—the unmoulded abacus, the flat face on which volutes and palmettes are painted, and the mortice hole into which the shaft was tenoned—take us back to the very borderland between wood and stone construction. Perhaps this, and other examples like it, belonged to that period of mixed wood and stone construction, when wooden shafts supported stone capitals, which Durm describes in tracing the origin of the Ionic order. It is certainly a remarkable fact, that among so many capitals which have survived the destruction by Xerxes, so few shafts have survived, which is just the reverse of what we should expect. Only one example among these numerous archaic Athenian capitals is preserved with a stone shaft, and that shaft is of the Doric order; the inscription on the shaft, telling us that it is a votive offering of Alkimachos, can be attributed to the middle of the sixth century (see Puchstein, Fig. 6). In the great distance between the volutes, which hang completely outside the line of the shaft, it resembles the contemporary Ephesian capital. I am therefore inclined to place the whole chronology of these capitals somewhat earlier than is done by Puchstein. However this may be, the type of the poros fragment mentioned above is carried a step further in another of those capitals anterior to 480 B.C. It is the capital already mentioned as published in *Antike Denkmäler*, i., Plate 29. The volute is now traced by a slightly raised fillet, and a moulding with enrichment in flat relief is introduced between the abacus and cushion. In other respects it still resembles the poros fragment; but already it shows points of resemblance to the Kynosarges capital. The upper connecting fillet between the volutes is of graduated breadth, and the fillet encircling the eye gradually narrows down. These refinements are designed with a somewhat heavier hand than in our frag-

ment; but their presence shows that the date of the two examples cannot be far apart.

Our fragment is a further development as brought about by the influence exercised by the Asiatic type, which accounts for the presence of the moulding of the abacus, the boss of the eye, and the strength of the fillet. Still, in the treatment of the volutes and cymatium, the designer of our capital did not go so far as to carve the echinus and mould the volutes, as Mnesicles did in the Propylaea. All this makes me inclined to ascribe to our fragment a period anterior to that of the Propylaea, but at which the intercourse of the Athenians with the Asiatic Greeks had already had time to influence the design of their Ionic capitals. We can still better define the limits of the period to which the Kynosarges fragment belongs, by a survey of the history of the gymnasium of Kynosarges. That it belonged to this gymnasium is proved by the following circumstances:—

In the Palaestra of the gymnasium of Olympia were found Ionic columns with capitals representing the later Peloponnesian version of the European type; in the Palaestra of the gymnasium of Kynosarges we found our fragment representing the corresponding Athenian version of the fifth century B.C. That it formed a structural feature in a building is proved by the presence of the scamillus on the abacus; and the absence of dowel holes in the upper surface shows that it did not crown an isolated column carrying a statue. Now, the gymnasium of Kynosarges is hardly likely to have escaped destruction at the hands of Xerxes in 480 B.C. But we know that Themistocles showed great energy in rebuilding Athens; further, Plutarch tells us (*Vita Themist.* i.) that, when Themistocles presumably was a youth, he induced other young men born of good families to exercise with him in the gymnasium of Kynosarges, which up till then had only been used by the *nothoi*. So it is only natural to suppose that when Themistocles rebuilt Athens he also restored the gymnasium of Kynosarges, perhaps out of consideration for his former gymnasium, perhaps owing to the desire for it expressed to him by the Athenian population of his class. We can, therefore, safely assume that the surviving fragment of an Ionic capital is a remnant of a restoration of the gymnasium of Kynosarges by Themistocles in the decade between its destruction by Xerxes in 480 B.C. and the ostracism of Themistocles in 471 B.C.

As regards the probable height of the Ionic columns of the gymnasium of Kynosarges, we can only draw inferences from other examples with similar capitals, and from other local and contemporary Ionic capitals. In the next example of the type, the theatre capital, the upper diameter of the shaft is alone preserved to us, and bears to the diameter of the under surface of the capital the exact proportion of 875 : 1000, or 7 : 8. In Watt's example the proportion is 93 : 100. In the Ionic colonnade near the monument of Lysicrates it is 96 : 100. Again, Vitruvius gives a rule that the diminution of shafts of the proportions usual to the Ionic order is to be $\frac{1}{8}$ of the lower diameter, that is to say, the two diameters of the shaft shall have a proportion of 8 : 7.

If we suppose that this rule was applied to the theatre capital, we see that the lower diameter of the shaft was equal to the diameter under the capital. I have drawn it as such above the mouldings of the base (see Plate VII.). Owing to the thicker upper diameter of Watt's capital, its lower diameter must also have been thicker than the diameter of the capital. In Stuart's capital, owing to the small difference between the upper diameter of the shaft and the diameter of the capital, and the greater difference between the two diameters of the shaft, which have a proportion of 7 to 6, the lower diameter is much greater than that of the capital. On the whole, therefore, it is more likely that the lower diameter of the shaft of our fragment was greater than the diameter of the capital; especially since, owing to the greater freedom under the cushion, as before described, there must have been room for a thicker shaft under the capital. So if we assume that the two diameters of the shaft had the Vitruvian proportion of 8 : 7, we can very well suppose that the lower diameter of the shaft was 0·8 of a foot and the upper diameter 0·7, which would fit very well under the circle of the capital, which is 0·773; the proportion of the last two would then be 905 : 1000 as compared with 875 : 1000, 93 : 100, and 96 : 100 in the other capitals of the same type. Now the Ionic columns of the Propylaea have shafts of which the two diameters are very near to the Vitruvian proportion, the lower diameters exceeding this proportion only by $\frac{7}{1000}$ of the upper diameter; further, as these columns are in a position very similar to that occupied by the Ionic columns of a Palaestra as seen at Olympia, and as they are the nearest examples to our fragment in point of time, we can very well suppose that the column of our fragment was the same number of dia-

meters in height as the columns of the Propylaea ; that is to say, their height was 10 (or slightly more) times 0·8 of a foot, which gives a height of at least 8 feet.

Ionic columns of such a height could very well have stood at the entrances of the rooms round the central court of the palaestra. The greater height of the Ionic columns of the palaestra at Olympia, which is 12·24 feet, is only natural, seeing that the Kynosarges gymnasium was far less important than that of Olympia, which was a national institution. The presence of the scamillus on the abacus on both examples, and the nature of the roof covering, which was of baked clay, as shown by the antefixae, lead me to suppose that the superstructure supported by the columns of the Kynosarges gymnasium was of wood, as at Olympia. This would account for the entire loss of the entablatures.

Our ideas, however, of the reconstruction of the gymnasium of Kynosarges, must remain vague owing to the lack of data. Still, I hope to have succeeded in proving that there are many arguments strongly favouring the supposition that the fragment of an Ionic capital which we found belonged to the palaestra of the gymnasium of Kynosarges, and that no positive argument to the contrary can be adduced ; and, further, that it dates from a period at which it forms a link between the old Attic group of Ionic capitals and a later group hitherto not much noticed. The antiquity of this group, and the appearance of allied groups over the rest of European Greece, have led me to suppose that there was a widely-spread European type of Ionic capitals as opposed to the Asiatic and old Ionic types, represented at Ephesus and Naucratis, and introduced in the Propylaea and Erechtheion. Whether the first was, like the other two, also introduced from the East, it is impossible to determine ; perhaps the capitals of the rock-cut tombs at Telmessos and Myra are the only survivals of its Asiatic prototype ; but from the great age of the older Attic examples, it may be considered indigenous to that part of Greece, whence it spread to the rest of Greece (*e.g.*, the temple of Phigaleia, designed by Iktinos). The intrinsic beauty alone of our fragment is sufficient to arouse our interest, and our regret that so much that was beautiful has been utterly destroyed.

PIETER RODECK.

AN EPIGRAPHIC MISCELLANY.

I. AN ATTIC INSCRIPTION RELATING TO A RELIGIOUS ASSOCIATION.

THE following inscription, which I have the privilege of publishing here, is said to have been found in Plakka (the quarter of Athens near the Arch of Hadrian); it is at present in the library of the British School at Athens.

	ΣΥΝΟΥΤΑΙΟΙΚΑΤΑΣΚΕΥΑΣΑΝΤΕΣΤΟΓΥ-	
	ΜΝΑΣΙΟΝΔΙΚΕΡΑΙΩΙΚΑΙΑΝΘΩΙ	
	ΚΡΑΤΩΝ ΦΙΛΙΠΠΟΥ	ΔΙΟΝΥΣΙΟΣ ΣΤΡΑΤΟΥ
	ΝΙΚΙΑΣ ΦΙΛΟΞΕΝΟΥ	ΣΟΛΩΝ ΕΥΑΤΩΝΟΣ
5	ΠΑΡΑΜΟΝΟΣ ΑΡΣΤΕΙΟΥ	ΔΙΟΝΥΣΟΔΩΡΟΣ ΣΩΚΡΑΤΟΥ.
	ΖΩΠΥΡΟΣ ΑΦΡΟΔΙΣΙΟΥ.	ΑΝΤΙΚΡΑΤΗΣ ΑΝΤΙΓΕΝΟΥ.
	ΑΦΡΟΔΙΣΙΟΣ ΞΕΝΟΔΟΥ	ΧΑΡΙΚΛΗΣ ΦΙΛΟΞΕΝΟΥ
	ΘΗΒΩΝ ΔΑΜΩΝΟΣ	ΠΑΡΑΜΟΝΟΣ ΕΡΑΔΙΟΥ
10	ΔΑΜΩΝ ΕΡΜΑΙΟΥ	ΑΔΩΝ ΑΘΗΝΟΔΩΡΟΣ.
	ΚΑΦΙΣΙΑΣ ΟΜΟΛΟΧΟΥ	ΑΡ.ΣΤΟΦΑΝΗΣ ΕΥΔΟΞΟΥ
	ΚΛΕΙΤΟΜΑΧΟΣ ΣΤΡΑΤ...	ΜΕΝΕΚΡΑΤΗΣ ΕΠΙΚΥΔΟΥ.
	ΕΥΗΜΕΡΟΣ ΦΙΛΟΚΛΕ...	ΙΙΛΩΝ ΕΠΙΚΥΔΟΥΣ
	ΕΥΘΥΚΛΗΣ ΕΥΤ...	ΞΕΡΙΑΤΙΣ ΕΥΔΟΞΟΥ
	ΑΛΕΞΑΝΔΡΟΣ ΣΤΑΤΩΝΙΟΥΣ	ΛΑΔΩΝ ΕΥΔΟΞΟΥ
15	ΣΩΚΡΑΤΗΣ ΟΜΟΛΟΧΟΥ	ΤΙΜΟΚΡΑΤΗΣ ΣΩΣΟΥ
	ΟΜΟΛΟΧΟΣ ΑΡΙΣΤΩΝΙΟΥΣ	ΔΕΣΙΡΑΤΗΣ ΣΩΣΟΥ
	ΘΕΟΓΕΙΤΩΝ ΕΡΓΩΝΟΣ	ΤΙΜΟΚΡΑΤΗΣ ΕΥΣΙΛΑΟΥ
	ΝΙΚΟΚΛΗΣ ΟΜΟΛΟΧΟ.	ΚΑΠΙΣΙΑΣ ΕΥΔΗΜΟΥ
	ΣΤΡΑΤΩΝ ΚΛΕΙΤΟΜΑΧΟΥ	ΑΡΤΕΜΙΔΩΡΟΣ ΑΣΑΝΔΡΟΣ
20	ΠΟΛΥΣΤΙΑΤΟΣ ΤΜΩΛΟΥ	ΑΡΞΕΝΟΣ ΔΙΟΝΥΣΙΟΥ
	ΦΡΑΣΥΜΑΧΟΣ ΕΡΩΤΕΛΟΥΣ	ΜΗΝΙΤΟΣ ΑΡΜΟΞΕΝΟΥ.
	ΦΕΟΔΩΡΙΔΗΣ ΚΑΛΛΩΝ.	ΖΩΛΩΡΟΣ ΦΙΛΩΤΟΥ
	ΔΙΟΔΩΡΟΣ ΣΑΤΥΡΟΥ	ΔΗΗΤΡΙΟΣ ΤΗΣΩΝΟΣ
	ΔΙΟΝΥΣΙΟΣ ΔΙΟΝΥΣΙΟΥ	ΖΩΛΩΣ ΕΥΡΑΤΟΥΣ
25	ΘΗΒΑΔΗΣ ΕΠΙΚΡΑΤΟΣ	ΖΩΛΩΣ ΕΡΩΤΕΛΟΥΣ
	ΖΩΒΙΟΣ ΜΝΑΣΙΩΝΟΣ	ΓΑΘΥΚΛΗΣ ΣΤΡΑΤΩΝΟΣ
	ΜΕΛΑΝΘΙΟΣ ΕΡΩΤΛΑΟΥ	... Σ ΣΤΡΑΤΩΧΟΥ
	ΣΑΤΥΡΟΣ Α...	ΛΥ...
	ΘΕΟΜΝΗΣΤΟΣ ΑΠΟΛ...	ΑΠ...
30	ΚΑΛΛΙΞΕΝΟΣ ΑΠΟΛ...	ΑΡΙΣΤΟΙΡΑΤ...
	ΠΑΡΑΜΟΝΟΣ ΜΩΛΟΥ	ΕΡΩΤ...
	ΠΥΘΩΝ ΑΠΟΛΛΟΔΩ...	... ΟΥ
	ΦΙΛΟΔΗΜΟΣ ΑΝΔΡΟΝΙΚΟΥ	...
	ΝΕΑΡΕΤΟΣ ΧΑΡΜΩΝΟΣ	...
35	ΖΩΠΠΟΣ ΣΩΣΙΚΑΦΟΥΣ	...
	ΖΙΝΑΝΘΗΣ ΤΥΧΩΝΟΣ	...
	ΖΩΠΥΡΟΣ ΣΩΠΥΡΟΣ	...
	ΕΥΗΜΕΡΟΣ ΤΗΛΕΦ...	...
	ΔΙΟΝΥΣΙΟΣ ΕΥΚΡΑΤΟΣ	...
40	ΜΕΛΙΤΩΝ ΠΟΣΔΩΝΟΣ	...
	ΞΕΝΟΤΙΜΟΣ ΖΩΛΟΥ	...
	ΛΕΥΚΙΟΣ	...
	ΑΛΕΞΩΝ ΦΙΛΩΝΟΣ	...
	ΑΦΡΟΔΙΣΙΟΣ ΑΦΡΟΔΙΣΙΟΥ	...
45	ΕΥΦΡΟΝΙΟΣ ΦΙΛΩΝΟΣ	...
	ΠΟΠΛΙΟΣ ΠΟΠΛΙΟΥ	...
	ΦΙΛΟΜΗΛΟΣ ΚΑΜΙΛΩΝΟΣ	...
	ΔΗΜΟΚΛΗΣ ΝΙΚΑ...	...
	ΝΙΚΑΝΔΡΟΣ ΔΗΜΟΚΛ...	...
50	ΕΥΝΟΜΟΣ ΘΕΟΛ...	...
	ΛΥΣΩΝ ΔΗΜΟΚΛΩΣ	...
	ΕΥΦΡΑΙΟΣ ΖΩΠΥΡΟΥ	...
	ΔΕΣΙΠΠΟΣ ΦΘΟΓΓΟΥ	ΙΣΙΔΩΡΟΣ ΕΥΝΟΜΟΥ
	ΕΥΘΟΟΣ ΚΑΛΛΙΓΕΝΟΥΣ	ΦΙΛΙΝΟΣ ΚΑΛΛΩΝΟΣ

Συνθύται οἱ κατασκευάσαντες τὸ γυ-
μνάσιον Δι' Ἐκραιῶι καὶ Ἄνθαι·

- | | |
|-----------------------------|-------------------------------|
| Κράτων Φιλίππου | Διονύ[σ]ιος Σωστράτου |
| Νικίας Φιλοξένου | Σόλων Ἐ[κ]άτωνος |
| 5 Παράμονος Ἀρ[ί]στ[ων]ος | Διονυσόδωρος Σωκράτου[ς] |
| Ζώπυρος Ἀφροδισίου | Ἀντικράτης Ἀντιγένου[ς] |
| Ἀφροδίσιος Ξεν[ολ]άου | Χαρικλῆς Φιλοξένου |
| Θήβων Δάμ[ων]ος | Παράμονος Ἐρ[μ]αίου |
| Δάμων Ἐρμαίου | Ἄδων Ἀθηνοδώρ[ου] |
| 10 Καφισίας Ὀμολ[ωί]χου | Ἀρ[ι]στοφάνης Εὐδόξου |
| Κλειτόμαχος Στράτ[ωνος] | Μ[ε]νεκράτης Ἐπικίδου[ς] |
| Εὐήμερος Φιλοκλέ[ους] | [Φ]ίλων Ἐπικίδου |
| Εὐθυκλῆς Εὐτ[υχ]ί[ου] | [Δε]ξι[κρ]άτης Ε[ὐ]δόξου |
| Ἀλέξανδρος Στ[ρ]άτωνος | [Χ]άων Εὐδόξου |
| 15 Σωκράτης Ὀ[μ]ολωίχου | Τιμοκράτης Σώσου |
| Ὀμολωίχος Ἀρίστω[νος] | Δε[ξ]ικράτης Σώσου |
| Θεογείτων Ἐργωνος | Τιμοκρ[ά]της Εὐξιλάου |
| Νικοκλή[ς] Ὀμολωίχο[ν] | Κα[φ]ισίας Εὐδήμου |
| Στράτων Κλειτομάχου | Ἄρτ[ε]μίδωρος Ἀσάνδρο[ν] |
| 20 Πολύστ[ρ]ατος Τμώλου | Ἀρ[μ]όξενος[ς] Διονυσίου |
| Θρασύμαχος Ἐργοτέλο[υς] | Νί[φε]τος (?) Ἀρμοξένο[ν] |
| Θεοδωρίδης Κάλλων[ος] | Ζώ[πυ]ρος Φιλώτου |
| Διόδωρος Σατύρου | Δη[μ]ήτριος [Κ]τήσιων[ος] |
| Διονύσιος Διονυσίου[ν] | Ζωίλος Ἐ[πικ]ράτους |
| 25 Θηβάδης Ἐπικράτο[υς] | Ζωίλος [Ἀ]ριστοτέλους |
| Ζώβιος Μνάσω[νος] | Γλαύκ[ων] Στράτωνος |
| Μελάνθιος Ἐργοτέλου[ς] | Στρατ[ά]ρχου |
| Σάτυρος Ἀ | νασίδου |
| Θεόμνηστος Ἀπολ[λωνίου]? | Ἄπολ |
| 30 Καλλιξένος Ἀπολ[λωνίου]? | Ἄριστο[κρ]άτ[ης] ου |
| Παράμονος [Ἀ]μύ[μου] | Ἐργοτέ[λης] |
| Πύθων Ἀπολλοδώ[ρου] | |
| Φιλόδημος Ἀνδρονίκ[ου] | |
| Νεάρετος Χάρμων[ος] | |
| 35 Ζώιππος Σωσικλέους | |
| Ο]ϊνάνθης Τύχων[ος] | |
| Ζ]ώπυρος Ζωπύρο[ν] | |
| Εὐήμερος Τηλέφ[ου] | |
| Διονύσιος Εὐκρ[ά]το[υς] | |

- 40 Μελίτων Ποσ[ι]δω[γίου]
 Ξενότιμος Ζωίλου
 Λεύκιος
 Ἀλεξίων Φίλωνος
 Ἀφροδίσιος Ἀφροδ[ισ]ίου
- 45 Εὐφρόνιος Φίλω[νος]
 Πόπλιος Ποπλί[ο]υ
 Φιλόμηλος Καλλι[κ]λ[έ]ο[υ]ς
 Δημοκλῆς Νικά[ν]δρου
 Νικανδρος Δη[μ]οκλ[έ]ους
- 50 Εὐνομος Θεογ[ε]ίτωνος?)*
 Λύσων Δημοκλ[έ]ο[υ]ς
 Εὐφραῖος Ζωπύρου
 Δέξιππος Φθόγγου
 Εὐόδος Καλλιγέου
- Ἰσίδωρος Εὐνόμου
 Φιλῖνος Κάλλωνος

The stone is a rectangular slab of Pentelic marble, 38 in. by 16½ in. (96½ × 42 cm.). Unfortunately it has suffered from corrosion, which has quite obliterated part of the right-hand side, and often makes the words hard to decipher. In some doubtful details I have had the assistance of Mr. Cecil Smith.

The thinly cut letters belong to the Roman period. The forms† are, approximately—

Α, Δ, Η, Θ, Ζ, Κ (Κ), Π (Π), Σ (Ξ), Φ, Ω (Ω).

Lines 41—54 are a later addition, engraved somewhat irregularly in coarser characters; and lines 42 and 50 were at first omitted by the stone-cutter, and inserted afterwards in smaller letters. In this latter part occur the Roman names Lucius and Publius. The spelling Λεύκιος generally indicates a date prior to the middle of the first century of our era, after which Λούκιος is used; but in Athens the older form persists as late as A.D. 160.‡ This inscription, however, is not so late as that.

We have here a long list of *συνθύται* who combined to build a gym-

* The last letter in the uncial text looked like Γ tilted a little forward; it has been represented as Δ by a mistake.

† The copy exaggerates the size of the letters in the first two lines; they are only slightly larger than the rest.

‡ Dittenberger, *Hermes*, vi. 310; S. Reinach, *Traité d'Épigr. Gr.*, p. 520.

nasium "in honour of Zeus Keraios and Anthas." The term *συνθύται* is used in two different connections: (1) to denote the delegates sent by one city to offer joint sacrifice at a public festival of some other city (Apollod. ii. 7, 2; *C. I. G.* 1193, 2761-5); (2) to signify, as in the present case, a religious society or guild of persons who unite in the worship of certain special divinities. This meaning is paralleled by the expression *συνθύται τᾶμ Μωσάων*, a society formed for the worship of the Muses, in two inscriptions of Thespieae (*Göttingen Samml. d. griech. Dialekt-Inschr.*, 800; *B. C. H.*, 1885, p. 405). The gymnasium which is here put up at the expense, apparently, of certain members of the guild for the use of the whole body, is dedicated to *Ζεὺς Κεραῖος καὶ Ἄνθας*, obviously because these are the deities worshipped by the guild. It was built, of course, on the *τέμενος* consecrated to the service of these deities, and forming the religious centre of the community. Every religious association possessed such a centre. Of the inscriptions just quoted, the first is a boundary-stone *τᾶς γᾶς τᾶς [ἰα]ρᾶς τῶν σ[υν]θυτᾶων τᾶμ Μωσάων Εἰσιοδείων*, while the other records the dedication of a piece of ground to be sacred for all time, *τῆς Μ[ώσ]ης κῆ τῆς συνθύτης*. The erection of a gymnasium almost necessarily implies the existence of a sanctuary (*i.e.*, a temple, *ναός*) within the consecrated ground; for a sanctuary was always the first requisite. This brotherhood of *συνθύται*, therefore, bears a close analogy to religious associations of the *Θιάσοι* type.*

It seems probable that the original nucleus of the guild consisted, not of native Athenians, but of foreigners resident in Athens; † and that these foreigners were Boeotians. In the first place we are struck by the large number of Boeotian names which occur in the list. Names like *Κράτων*, *Παράμονος*, *Ζώπυρος*, *Ἐρμαῖος*, *Καφισίας*, *Ὀμολόιχος*, *Ἄδων*, *Μνάσων*, *Ζωίλος*, *Θηβάδης*, *Θήβων*, ‡ are solely or typically Boeotian; while others, such as *Πύθων*, *Ξενότιμος*, *Δάμων*, *Φίλων*, are quite characteristic of Boeotian nomenclature. Now *ΖΕΥΣ ΚΕΡΑΙΟΣ* is

* *Θιασώτης · ὁ κοινῶν τῶν θυσῶν · ἑκαλοῦντο δὲ καὶ οὗτοι Ὀργεῶνες*, Bekker's *Anecdota*, p. 264, 23. On the organisation of these associations see M. Foucart, *Des Assoc. relig. chez les Grecs*, p. 42 ff.

† Cp. for example, *C. I. A.* ii. 168, *C. I. G.* 2271, &c. Others would, of course, be subsequently admitted. One of the distinctive features of such associations, however, was the admission of foreigners, as well as women, and even slaves, to membership.

‡ *Θήβων*, *Θηβάδης*, *Ἐργων*, *Νεάριτος*, *Οἰνάνθης* and *Φθόγγοι* are unknown to Pape-Benseler (last ed.), while *Τμῶλος* and *Χάων* occur only as heroic names.

undoubtedly the horned Zeus-Ammon, who had a temple at Thebes (Paus. ix. 16), and was probably worshipped in other parts of Boeotia. The foreign cult suits the character of a society of this type. The adjective *κεραιός* is unknown to the lexicons, which quote only the ordinary form *κεραός*; but any doubt about the equivalence of the two forms and the identification of the Zeus cult is set at rest by the occurrence of *Ἀμμωνος κεραιοῖο* in an inscription of Alexandria (*Rev. Archéol.*, 1874, p. 51 = Kaibel, *Epigr. Gr.*, 833): while the usual form *Ἀμμωνος κεραού* is found in an inscription of Beirût (*C. I. G.*, 4536 = Kaibel, 835).

It is less easy to determine the precise explanation of the words *καὶ ΑΝΘΑΙ*. The cult of *ΑΝΘΑΣ* belongs especially to Troizen and Anthedon in Boeotia.* Anthas is specially connected with Troizen. According to the legend, he founded Antheia, while his brother Hyperes founded Hypereia, the two towns being afterwards united to form the city of Troizen (Paus., ii. 30). He also gave to the subject island Kalaureia its older name Anthedon.† In the beginning of the third century B.C. we find a Troizenian citizen Diomedes, who was honoured by his country with a bronze statue at the temple of Amphiaraios, near Oropos, tracing his descent *Ἀνθ[α] ἀπ' εὐσήμεου*.‡ But Anthas is also the eponymous founder of Anthedon on the Boeotian coast.§ *Ἀνθης ὁ ἐξ Ἀνθηδόνας τῆς Βοιωτίας* is mentioned as a poet contemporary with Linos and Amphion (Ps. Plut., *Περὶ Μουσικῆς*, c. 3). In both places the cult is the same. Now Anthedon of Boeotia, being the harbour of Orchomenos and subject to that city, was connected with Anthedon-Kalaureia and Troizen in the old Amphictiony of Kalaureia (Strabo, viii., p. 374).|| Both at Troizen and at Anthedon, Anthas is called the son of Poseidon, *i.e.* *Ποσειδῶν Φυτάλμιος* (Paus. ii. 32, 8), and his wor-

* From Troizen it was carried to Halicarnassos and Myndos (Strabo, pp. 374, 656; Paus. ii. 30, 9; Steph. Byz., s. v. *Ἀλικαρνασσός* and *Ἀθηναί*. Cp. *C. I. G.*, 2655). It perhaps also existed at Anthana in Laconia (Steph. s. v.).

† Aristotle *ap.* Plut. *Quæst. Gr.* 19 and Athen. I., p. 31 c; he gives the form *Ἀνθηδοσία*, while the oracle which he is explaining has *Ἀνθηδών*.

‡ *Ἐφ. Ἀρχ.* 1892, p. 49 (dating *ca.* 278 B.C.), emended by Diels, *Arch. Anz.* in *Jahrbuch*, 1893, p. 138 (cp. also *Zft. f. d. öst. Gymn.*, 1893, p. 1074).

§ Paus. ix., 22, Steph., s. v.

|| See the excellent paper of Wilamowitz-Möllendorff, *Die Amphiktionie von Kalaurea* (in *Nachrichten d. K. Gesell. d. Wiss. zu Gött.*, 1896, Heft 2). Starting from an inscription found during the Swedish excavations at Kalaureia (*Ath. Mitt.*, 1895, p. 295), he gives the best explanation of this *ἀμφικτιονία*, rightly rejecting the theory of a Mycenaean maritime league.

ship is thus associated* with that of the great god of the seafaring peoples around the Saronic Gulf, who had his seat at Kalaureia and Troizen, at the Isthmus,† and at Sounion,‡ as well as at Athens.§

We might therefore be inclined to see, in the introduction of the Anthas cult alongside of that of Zeus Keraios, a further indication of Boeotian influence. But it is more than probable that the cult existed also in Attica, where we have already found the worship of Poseidon Φυτάλμιος. Indeed the existence of a parallel cult in Attica is proved by an entry in a sacrificial calendar from the Epakria district (published by Mr. Richardson in *Amer. Journ. Arch.* 1895, p. 210), Δὺ Ἀνθαλεῖ οἷς Δ†† (l. 47) || This passage, moreover, suggests that the Ἀνθας of our inscription is to be regarded, not as a separate divinity, but as a second epithet of Zeus, ascribing to him the attributes that are elsewhere assigned to Anthas, son of Poseidon Phytalmios; and this seems to me the preferable view. But, in either case, the cultus is in reality one and the same: it is the worship of the fertility of Nature, of that mysterious productive power seen both in vegetation and in animal life, which is ascribed now to one deity, now to another—to Zeus as Ἀνθαλεύς, to Poseidon as Φυτάλμιος¶ or to his son Anthas,** to Dionysos as Ἀνθιος, Ἀνθεύς, Ἐὐανθήης, to Demeter,†† or to Γεῦ.‡‡ Ζεὺς Κεραϊὸς καὶ Ἀνθας would be a suitable expression for the power that presides over animal and plant life: and our guild may well have been a guild of farmers.

* At Halicarnassos Ἀνθειάδαι was the name of the family which held the priesthood of the Poseidon cult brought from Troizen (cp. *C. I. G.* 2655).

† Thuc. viii. 10; Plut. *Thes.* c. 25.

‡ Herod. vi. 87, cp. *C. I. A.*, i. 196.

§ *C. I. A.* 269, Paus. i. 37, 2.

|| This reference was given me by Mr. Cecil Smith. The entry immediately preceding is imperfect [. . . .] μ κριὸς Δ††; it would be worth while examining the stone to see if [Δὺ Κεραϊ]ῶ might be restored.

¶ Ποσειδῶνα (at Troizen) . . . , ᾧ καὶ καρπῶν ἀπάρχονται καὶ τρίαναν ἐπίσημον ἔχουσι τοῦ νομίσματος. Plut. *Thes.* c. 6. On this cult, see Preller-Robert, *Griech. Myth.*, p. 586.

** The form of the name varies between Ἀνθας (Paus. ii. 30, ix. 22), Ἀνθης (Strabo, pp. 374, 656; Plut. *Quaest. Gr.* 19 and *Athen.* i. p. 31c, where he is connected with the vine), Ἀνθος (Plut. *l.c.*), and Ἀνθιος (Schol. to Hom. *Il.* ii. 508).

†† Cp. Toepffer in Pauly-Wissowa, *Real-Encyc.* p. 2359, s.v. Anthedai.

‡‡ Cp. *Amer. Journ. Arch.*, *l.c.* (and p. 214).

II.—INSCRIPTIONS FROM KYNOSARGES.

OF the inscriptions which were found during the excavations of the British School at Kynosarges the most interesting is a small leaden tablet measuring $4\frac{3}{4}$ in. \times $2\frac{3}{4}$ in. (12 cm. \times 7 cm.), folded up in three and pierced through with a hole. It was discovered about two metres down in a circular shaft near the centre of the western side of the Gymnasium. It is possible that it was originally nailed to the wall of this shaft; but of the nail which may have passed through it no traces were discovered. On being unrolled it was found to have the following inscription engraved on the inner side:—

1.

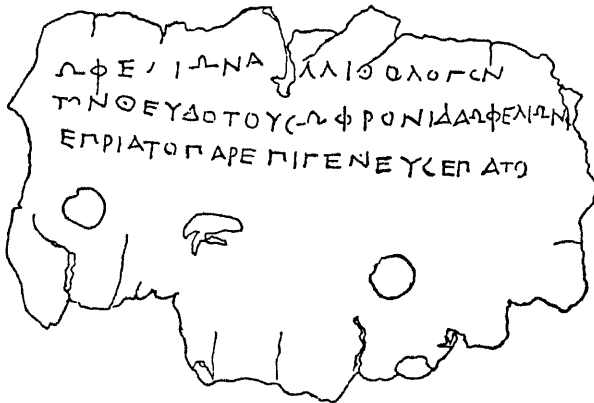

Ὀφελίωνα [τὸ] λ λιθολόγον
τὸν Θεόδου Σωφρονίδα Ὀφελίων[ος
ἐπρίατο παρ' Ἐπιγένεως Ἐπ[ήρ]ατο[s] (?).

The letters are well inscribed and quite certain.

Leaden tablets rolled up in this way, with the writing inside, generally relate to sorcery, and belong to the class of *κατάδεσμοι* or *defixiones*, magical imprecations inscribed on a tablet and buried in the earth, such as Tacitus mentions in the case of Germanicus (*carmina et devotiones et nomen Germanici plumbeis tabulis insculptum*, *Ann.* ii. 69).*

* They have now been published as an appendix to *C. I. A.* by Wunsch (1897).

This tablet, however, is quite different, and appears to be unique of its kind. Only one interpretation seems possible: "Ophelion, the builder, the property (slave) of Theodotus, and Sophronis, the daughter of Ophelion, were purchased from Epigenes by (?) Ερ[er]ato[s]." Theodotus was the former owner of Ophelion, and Epigenes was the slave-dealer from whom the two purchases were made. While this interpretation seems clear, it is not easy to say what the exact purpose of the tablet was. The idea, which the existence of the hole suggests, that it was meant for a kind of slave's collar to serve for identification, is perhaps precluded by the shape. It may be merely a deed of sale, but in this case we should certainly expect the price to be mentioned.

Stoneworking of all kinds is a well-known occupation of slaves. Ὀφελίων occurs in Diog. Laert. (*Vit. Phil.* v. 4) as a freedman's name, and Ὀφελίων Θραῖξ, in *C. I. A.* ii. 3035, is undoubtedly a slave. Λιθολόγος is quite well known from literary sources, but does not seem to occur in inscriptions so frequently as λιθοτόμος or λιθοκόπος. Λιθόγημα, λιθολογία, and λιθολογέιν, all occur in a long inscription of Eleusis, dealing with temple-building expenses (*C. I. A., Suppl.*, 834b, col. 1, 76, sq.); λιθόγημα in an inscription of Peiraeus (ca. 394 B.C.) published by Köhler in *Ath. Mitt.*, iii. 51; and λιθολόγος in another Eleusinian document (*B. C. H.*, vii. 389). But in several cases it is quite possible that λιθολόγος should be restored, e.g., *B. C. H.*, i. 401, where M. Bayet restores λιθο[κόπο]υ, or *C. I. G.* 7158, restored by the editor Ἀπολλοδότου λιθο[γλύφου].

The final assimilation of ν in τὸλ λιθολόγον is paralleled by such examples as τῶλ λογιστῶν (Dittenberger, *Sylloge*, 14, 9), or ἐλ Λυρισσῶ in an inscription of Halicarnassus (*ib.*, 6). Such assimilation generally points to an early date. Σωφρονίς is not given by Pape-Benseler, but occurs in *C. I. A.* iii. 3378 on a sepulchral stelè.

The form Θεύδοτος is noticeable. Meisterhans (*Gramm.*² p. 48) says that the contraction of εο into ευ is found in Attic inscriptions of the classical time only in isolated cases of Ionicising personal names, such as Θευγένης, Θευγείτων (*C. I. A.* 324);* while from the third century onwards it also occurs in Attic words, e.g., Θεείδοτος Χολαργεὺς (*C. I. A., Suppl.*, 964b). We see, however, from an Athenian inscrip-

* 408 B.C.—He points out that these may be enfranchised foreigners, as belonging to the deme Peiraeus.

tion, probably of the year 313-12 B.C. (*Ath. Mitth.*, 1896, p. 303), that the new spelling had begun in the fourth century; there the two forms occur side by side. In the Aegean islands the form *eu* is very common.*

The genitive form, Ἐπιγένης, which shows a similar tendency, seems to be unknown in Attic inscriptions. Meisterhans gives no instance. In the islands, again, this Ionicising form, as we may call it, is exceedingly common, e.g. in Cos and Rhodes.† It is therefore possible that the parties in this business transaction were not native Athenians, but islanders resident in Athens.

Next comes a short series of Christian inscriptions.

2.

*
Ἰνάχου.

The letters are carelessly engraved.

3.

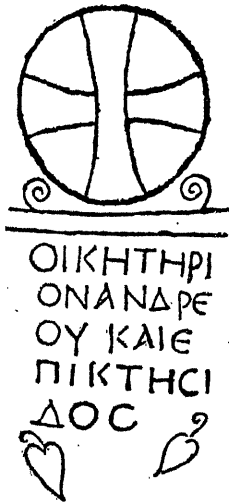

Οικητήρι-
ον Ἀνδρέ-
ου καὶ Ἐ-
πικτησί-
δος.

On the side of this stone are two late Ionic capitals in relief.

* Cos (on coins of third cent. and inscr., Paton-Hicks No. 10, &c.); Rhodes (e.g. *Ath. Mitth.* 1877, 224); Delos (*B. C. H.* vii. 106); Carpathos (*B. C. H.* iv. 271, 276), &c.

† See Paton-Hicks, No. 10, &c. For Rhodes, *Ath. Mitth.*, *l.c.*, and Cauer's *Delectus*, No. 195 (Amphora handles).

Very few of the Christian inscriptions of Attica are earlier than the fifth century. In two interesting papers in *B. C. H.*, vols. i. and ii., M. Bayet assigns the majority of the earlier inscriptions to centuries five to seven, and this conclusion is borne out by the evidence. The presence of the so-called Constantinian monogram in No. 2, and of the monogrammatic cross in No. 3, is interesting, and affords a criterion of date.* In the East, where the various monograms originate, ✠ belongs to the early fourth century (perhaps also to the third),† while the monogrammatic and simple cross appear about the middle of the fourth century. No. 2, then, probably belongs to the fourth century, and No. 3, with its cross and good lettering, may be assigned to the latter half of the same century.

Οἰκητήριον, in Nos. 3 and 5, in the sense of "tomb," seems to be a local Attic usage. *Κοιμητήριον* in the same sense is much more characteristic of Attic inscriptions, though M. Bayet's remark (*B. C. H.*, i. p. 392), that "ailleurs ce mot est en général appliqué à un ensemble de tombeaux, à une nécropole," will not hold. It occurs, for instance, frequently in the Attic sense in Christian inscriptions of Phrygia.‡ The use of *οἰκητήριον* for "tomb" is probably a Christian modification of the older term, *οἶκος*, *domus*, influenced by the idea of a heavenly dwelling-place (*τὸ οἰκητήριον τὸ ἐξ οὐρανοῦ*, 2 Cor. v. 2).§ The idea of the grave in antiquity is always that of a dwelling into which the dead enters, there to begin a new and better life, like his life on earth. Hence the expression *οἶκος*, *domus*, and *οἶκος αἰώνιος*, *domus aeterna*, to denote the tomb or home of the dead.|| *Οἶκος αἰώνιος* passes over into

* Le Blant, *Manuel d'épigraphie chrét.*, p. 27 ff.; Bayet, *Revue Arch.*, 1876, ii. p. 287 f.; and Ramsay, *Cit. and Bish. of Phrygia*, Nos. 371, 653, 673.

† The inscr. of Eregli (Herakleia-Perinthos) in Thrace (Dumont, *Inscr. et mon. fig. de la Thrace*, p. 42 [*Archives des miss. scient.*, 1876, p. 154]) which contains this monogram three times after each name, and was thought by De Rossi "to be of an epoch anterior to Constantine," is probably to be assigned to the third century on account of the occurrence of the *praenomen* Aurelius in each of the three names, on the principle enunciated by Ramsay, *J. H. S.*, 1883, p. 30, *Cit. and Bish.*, vol. ii., No. 235. Cp. Dittenberger, *Inscr. von Olympia*, No. 110.

‡ E.g. Ramsay, *op. cit.* Nos. 445, 654, 655, 659, &c.

§ Quoted by M. Bayet.

|| *Οἶκος* in *B. C. H.*, 1883, 239 (Isauria); Kaibel, *Ep. Gr.* 262 (Corcyra); *B. C. H.*, 1878, 610 (Cibyra); *B. C. H.*, 1894, 11 (Magnesia), &c. *οἶκος αἰώνιος* in *C. I. A.* iii. 3510 (Athens); *I. G. S. I.*, 1464 (Italy); *Ath. Mitth.* 1888, 246 (Laodiceia Combusta): cf. Kaibel, 321, *οἶκος ἐναίδιος*. For *domus* and *domus aeterna*, see the references in Marquardt, *Handbuch* vii., p. 365, n. 5. The idea of deification, which sometimes occurs, is of course not excluded: *οἶκος* may mean "temple" as well as "house."

Christian inscriptions in the same sense as *οἰκητήριον* (*C. I. A.*, iii. 3509; *I. G. S. I.*, 463).

4.

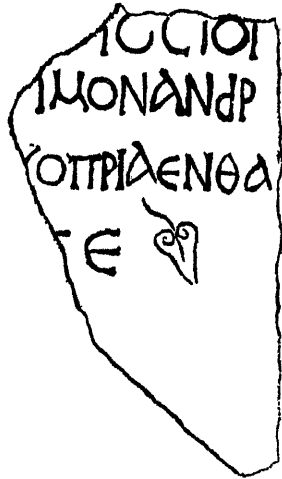

. . . ἀνδρ[α
Κ]οπρία ἐνθά-
δε κῆτ[ε].

The name *Κοπρία* proves this inscription to be Christian. It is found in an inscription of Catana belonging to the Roman time (*C. I. G.* 5712 = *I. G. S. I.*, 497); at Lete in Macedonia in 181 A.D. (Duchesne and Bayet, *Miss. au mont Athos*, p. 100); and also at Syracuse (*B. C. H.* 1896, p. 400). The masc. form *Κόπρων* occurs in the fourth century at Iasos (*B. C. H.* v. 497), and in the fifth century at Halicarnassos (*B. C. H.* iv. 505).* *Κοπριανός* is found in a Christian inscription of Syracuse† (*I. G. S. I.*, 137). These all belong to a remarkable category of names expressing utter self-abasement, which were adopted by the early Christians both in the East and in the West. Similar names are Stercorius, Foedula,‡ Asbolos (“soot”), § and many others. They are to be explained (with M. Le Blant) as terms of insult and reproach levelled by the pagans against the Christians, and accepted by them with a joyous resignation, which “a inspiré aux fidèles l’admirable constance de chérir une apparente ignominie cent fois plus glorieuse,

* For some of these references I am indebted to M. Perdrizet.

† *Κόπρος*, the name of an Attic deme belonging to the tribe Hippothontis (see Böckh on *C. I. G.* 145 = *C. I. A.* i., 185) is not connected with this class of names, though Aristophanes plays on it in *Eq.* 899, *Eccl.* 317. It is clearly connected with the hero *Κοπρεύς* (see Roscher’s *Lexicon*, s. v.).

‡ M. Le Blant, *Revue Arch.*, 1868, ii., p. 4 ff.; *Inscr. Chrét. de la Gaule*, ii., p. 66 ff.

§ Ramsay, *op. cit.*, p. 493, and Nos. 28, 412.

à leurs yeux, que ne l'eussent été tous les honneurs du siècle." It is to be noted that the existence of such names in Greek, analogous to but certainly not imitated from the Latin forms, clearly disproves the theory propounded by Mowat against Le Blant (see *Rev. Arch.*, 1868, i., p. 360 f.), that Stercorius, for example, originated in Roman Africa, being the Latin equivalent of the Punic name Pirasius (which he thinks has a similar signification).

The next two inscriptions probably belong to the ninth or tenth century. The letters are of the very latest and most degenerate form.

5.



Ῥκκτῆρι-
ον Ῥνω-
χᾶ (or Ῥνωχᾶ?) κὲ Πο-
θυμένη[ς].

6. ΟΥΚΗΛΑ
ΚΑΙΤΕΡΑ
ΟΥ

Οὐκηλᾶ
καὶ Τετραδί-
ου (?).

Some inscriptions with similar late lettering, dated in the ninth and tenth centuries, are published in *Ἐφ. Ῥρχ.*, 1886, p. 235. Ῥνωχᾶς is an unknown name; Ποθυμένη occurs in *C. I. G.* iii. 4468. The names in No. 6, like Ῥνωχᾶ, have a foreign look about them. If

Τεδράδιος is right, an analogy might be found in such Lycian names as Ἐρμένδαδης Τέδικτα (*C. I. G.* 4315 *f. add.*).

7. A slab of Pentelic marble, broken away irregularly along the lower side; height .47 m., width .45 m., thickness .12 m. The stone bears traces of an earlier inscription, which has been cut down to make room for the present one. The letters of the earlier inscription are much larger, and appear to be of a good period: they are visible on the border and on the central disc, as follows, ΙΣ . . . Υ . . . ΛΣ.

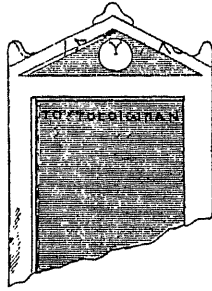

ΤΟΥ ΤΟ Ε Ο Ι Ω Π Α Ν
 Α Π Ο Τ Μ Ε Χ Υ Τ Ο Ν
 Π Ε Ρ Ι Σ Η Μ Α Θ Α
 Ν Ο Ν Τ Ι Χ Ε Υ Α
 Τ Ο Π Ρ Ι Ν Ζ Υ Γ Ι Ω Ν
 Α Ν Τ Ι Α Λ Α Ι Θ Α Λ Α Μ Ω Ν
 Ε Υ Γ Ε Ν Ι Ο Σ Γ Ε Ν Ε Η Ν
 Τ Ε Κ Α Ι Ο Υ Ν Ο Μ Α Κ Α Ι
 Χ Θ Ο Ν Ι Κ Ο Ν
 Ζ

Τούτο σοι, ὦ πανάποτμε, χυτὸν περὶ σῆμα θανόντι
 χεύατο πρὶν ζυγίων ἀντίασαι θαλάμων
 Εὐγένιος γενεὴν τε καὶ οὖνομα καὶ χθόνα . . .
 ξυ . . .

Eugenios occurs as a Christian name (*C. I. G.* 3857 *g*, 9199; Ramsay, *op. cit.*, No. 410 *bis*); but this inscription has nothing to mark it as Christian. The jingle Εὐγένιος γενεήν is characteristic of the metrical epitaph: probably εὐγένιος is meant to do duty both as personal name and as adjective in the sense of εὐγενής (*Hesych.*, *s.v.*). With χυτὸν περιχέυατο *cp.* χυτὴν καταχεύαι (*Kaibel, Ep. Gr.*, 1034, 25). The collocation γενεήν, ὄνομα, χθόνα occurs in *Anth. Pal.* vii. 164, which is imitated in an epigram of Philomelion (*Kaibel*, 248).*

The remaining inscriptions consist of sepulchral epitaphs inscribed on ordinary round *ciφφι*.

8.

ΠΑΜΦΙΛΟΣ
ΖΩΣΙΜΟΥ
ΜΕΙΛΗΣΙΟΣ

Πάμφιλος
Ζωσίμου
Μειλήσιος

Μειλήσιος, with the same spelling, in a similar *ciφφης* from the Dipylon, 'Εφημ. 'Αρχαιολ., 1895, p. 171, No. 13. Μίλησιος occurs very frequently in the series there published.

9.

ΓΝΑΙΟΣ
ΑΚΑΣΤΟΣ
ΜΑΡΑΘΩ
ΝΙΟΣ

Γναίος
'Ακαστος
Μαραθώνιος

These two are of the same period, with ornamental but good lettering.

* An improved copy of this epigram, which I made in 1897, is published in *J. H. S.*, 1898, p. 112.

10. I may add here another inscription of the same class, which lies by a cottage close to where the excavations were carried on. It is, so far as I know, unpublished.

ΑΠΟΛΛΩΝΟΣ
 ΣΟΛΩΝΟΣ
 ΣΙΔΗΤΗΣ
 ΚΑΡΠΟΣ ΤΩ
 ΘΡΕΨΑΝΤΙ
 ΚΑΙ ΕΥΕΡΓΕ
 ΤΗΜΝΗΜΗΣ
 ΕΝΕΚΕΝ
 ΘΕΟΣ

Ἀπόλλωνος
 Σόλωνος
 Σιδήτης
 Κάρπος τῷ
 ὀ. θρέψαντι
 καὶ εὐεργε-
 τῇ μνήμῃ
 ἔνεκεν.
 Θεο[ῆ]ς.

Sidetes Karpos erects the monument to his foster-father and benefactor, Apollon, son of Solon. Karpos is probably an adopted foundling (*alumnus*), not a slave born in the house (*verna*). It is often impossible to decide which sense *θρεπτός* (or *θρέμμα*) bears: see Ramsay, *op. cit.*, i. pp. 147, 350; ii. p. 546. In *B. C. H.*, 1884, pp. 55, 63, *θρεπτή* is in both cases a slave.

Apollon is rare as a personal name: it occurs (though doubted by Dittenberger) in an Attic inscription (*C. I. G.* 189 = *C. I. A.* iii. 1062) of 210 A.D., where *Κάρπος* also is found.*

Σιδήτης is mentioned once in an inscription from Rome (*C. I. G.*, 6467 = *I. G. S. I.*, 1558).

J. G. C. ANDERSON.

* *Κάρπος*, also 'Εφ. Ἀρχ. 1895, p. 172, *C. I. A.* iii. 3510, &c.

A NEW COPY OF THE ATHENA PARTHENOS.

(PLATE IX.)

I.

THE Athena Parthenos of Pheidias is so well known to us from the records of antiquity, and from the works of art which have come down to us more or less inspired by it, that we can safely claim to know at least what the essential features of the statue must have been; and yet there is, and must always be, in the almost certain impossibility of our recovering any part of the original, a large residuum of uncertainty and conjecture, not only as regards the details, but principally as regards the artistic form of Pheidias' figure. Where knowledge can only be based on deduction from a series of more or less closely connected data, every fresh addition to these data must be welcomed as ever so slight a strengthening of probabilities; and therefore the acquisition of a fresh piece of evidence is important, even though it adds but little to our preconceived ideas.

The statuette shown in the two views on Pl. IX. was discovered accidentally at Patras, in the summer of 1896 (so far as we could learn), in the square called the Psilalonia. From the records—unfortunately too scanty—of discoveries made from time to time on this site,* it is clear that it must have been a place of some importance in the ancient town; these remains appear to have been generally discovered by chance, and so far as I know, no regular excavation has yet been made on the spot. Considering that the antiquities of the Roman period, at any rate, lie very close to the surface, it is probable that a good deal of unrecorded

* Cf. *Ath. Mitth.* 1895, p. 233, architectural remains, including unfluted drums of columns 1.50 m. high by 1 m. in circumference; *ibid.* p. 376, an ancient well 6 m. deep.

discovery must have been taking place here for a long time past. In some cases, the denudation of the surface soil by heavy rains has been sufficient to lay bare Roman remains; but it is quite possible that an excavation might reveal, at a lower depth, the remains of the Greek period.

We (Mr. Bosanquet, Mr. Clark and myself) had been attracted to Patras, in November, 1896, by the announcement in an English paper, of the discovery of a fine mosaic pavement in the Psilalonia. As no account of this mosaic has yet appeared, I may be allowed to make it the subject of a small digression here. It appears that a short time before our visit, a heavy rain had one night washed away a considerable quantity of surface from the square, and revealed the existence of the mosaic; the further clearing and cleaning of the design was due to Mrs. Wood, the wife of the British Consul at Patras, who herself did what was necessary to make this interesting pavement available for study. When we saw it, some rough posts had been driven, partly into and partly round it; and some rails afforded an inadequate barrier against the local street boys and others, whose depredations had unfortunately left only too obvious traces in the destruction of part of the design.

After our departure, Mr. Clark returned to Patras from a short tour in Achaia, with the intention of making a complete coloured rubbing of the mosaic; but his work was rendered almost impossible by a spell of bad weather, so that he was only able to complete a coloured rubbing of one figure, and a rough sketch of the whole. Mr. Poynter, two months later, tried to make a study of it, but by that time it had been reburied by the authorities.

The pavement covers a rectangular oblong space, 6.60 m. long by 2.50 m. wide: the designs are enclosed within a border of large bead-and-reel pattern .20 m. wide, which is itself enclosed within a double line of white and red tesserae; at each corner of the bead-and-reel is a quatrefoil. Within this, again, is a band of cable pattern, .12 m. wide, of which the strands are alternately yellow, red, and white, and each pattern is bounded by a line of red inside a line of white tesserae. A similar band of cable pattern divides the mosaic longitudinally into two equal parts, each of which contains a frieze of figures. In the upper frieze, which has suffered the most damage, is a series of figures holding masks, standing in various attitudes conversing, with a large table in the

centre: some of the figures appear to be musicians, and the one on the extreme right* is a kitharist, wreathed, and apparently beardless, who steps to left with his face turned nearly to front, his right arm extended holding a plectrum, with which he has just struck the chords of a large kithara on his left arm.† He wears a long red chiton barred horizontally with blue, a variegated mantle hanging from his shoulders, and yellow boots. The ground line is black, and the colours employed are green, yellow, purple, black, white, and dark blue, on a white ground.

The subject of this scene appears to be the preparation for a Dionysiac contest, in which music and the drama are represented. The lower scene forms an appropriate pendant: here the different contests of the palaestra are represented by athletes singly or in groups, each contest being separated from the rest by the figure of an athlete bearing a palm branch. This scene has in all twenty-one figures.

The mosaic is fairly careful and spirited in design, and the tesserae of which it is composed are, as a rule, small; in its style it resembles a mosaic found in the German excavations west of the Acropolis, and must be assigned to about the second century A.D. The unusual character of the subject in the upper design makes it highly desirable that a proper publication should be made of it by some one who can devote more time than we were able to give to it.

II.

The Demarcheion of Patras is distinguished by two imposing sarcophagi flanking the doorway, which naturally attract the inquisitive archæologist. On the occasion of our visit, the Demarch himself was away, but an obliging townsman introduced us to a ragged little pile of sculptures which lay forlornly heaped in a corner of the official reception room; presumably the jetsam cast up by chance and the weather at Psilalonia. These included a marble torso of Artemis, apparently of late Greek work, about 2 feet high; the base of a marble group, of which the feet only are preserved, and which has probably

* Of this figure Mr. Clark succeeded in making a full-sized coloured rubbing.

† For this figure *cf.* the paintings from Cyrene, published in Pacho, *Voyage dans Cyr.*, Pl. XLIX. and L., which offers, perhaps, the best parallel to the composition of the Patras mosaic.

represented Eros embracing Psyche; and a marble slab with a relief representing a sepulchral banquet of the usual type. These, however, were obviously of small importance compared with the statuette (Pl. IX.) which we were fortunate enough to unearth from its squalid surroundings, and which forms the subject of the present paper.

The marble is Pentelic, and the surface generally is in excellent condition; the left foot in particular, which, from its position, has been well protected, shows that fine gleaming texture, the *γάνωσις* of Vitruvius, which suggests that the flesh was toned by an artist. Here and there a good deal of hard cement adheres, as if the figure had been built into a wall; in our hasty survey we could discover no traces of colour, but possibly cleaning may disclose some traces.

The head seems to have been made in a separate piece, and to have been firmly fixed in a socket, so firmly, indeed, that the barbarian who coveted it found it necessary, in order to detach it, to break away the greater part of the right shoulder and shoulder blade;* the same injury probably caused the loss of the right arm; the left one is wanting from the middle of the biceps; the drapery in the lower folds has suffered minor abrasions, but is generally in good condition; the right foot has also suffered an abrasion which appears to be recent; the upper part, forming about two-thirds, of the snake and shield are wanting; the pedestal is practically complete.

The total height of the figure, so far as it is preserved, is 0·865 m. (about 34 inches), which is made up as follows:—height of base 0·075 m.; base to end of apoptygma, 0·432 m.; thence to centre of girdle, 0·203 m.; thence to chin of Gorgoneion, 0·076 m.; thence to angle of V of drapery, 0·076 m. The base is, roughly speaking, 0·38 m. in width, and the same in depth.

In spite of the somewhat heavy catalogue of disasters given above, sufficient of the original still remains, as may be seen from Pl. IX., to show that, in its position and general lines, the figure corresponds exactly with what we know of the Parthenos from other sources. The body stands firmly poised on the right leg, with the left slightly drawn back, and, as a balance to this, the right shoulder is slightly raised, as

* Probably he was anxious to detach, with the head, the whole of the hair and the crest of the helmet, and therefore began his tooling below the point where the end of the crest and the hair met. There is no trace left of either.

would be the case if the right hand had held a weight and lay at rest. The left foot rests only on the tread, and behind it, at the back, the drapery is slightly lifted to show the heel; here we see that the sole of the sandal has been thickened to give the foot the necessary tilt forward. In its general lines the drapery follows the same scheme as the other existing replicas, but in none of them is the characteristic effect which we may *a priori* assume for the Pheidian statue so gracefully suggested as here. The folds, though they are most carefully worked, are free in treatment; and in depth and undercutting they remind us of Schreiber's remark (*Athena Parthenos*, p. 65), that this characteristic, unsuitable to work in marble, is necessary in the chryselephantine technique, in order to counteract the reflection of the gold, and to produce stronger shadows.

The drapery consists of a chiton, open down the right side, having a long apoptygma which is fastened at the waist with a girdle; as in all the other copies, this girdle consists of two snakes, whose bodies are fastened in a knot, on either side of which the head and neck form a spiral coil, suggesting the disks of a modern buckle; in our copy the snakes' heads are wanting, otherwise the girdle is perfectly preserved. This girdle is placed rather low on the body, and thus the artist is left ample room to trace home the beautiful oblique folds which, starting from the central knot of the girdle, branch out on either side to the breasts, whose form they help to define; this effect is still further aided by the modelling of the aegis, which, instead of being (as in the Varvakeion statuette) a mere shapeless slab, is delicately adapted to the form beneath it, so that the Gorgoneion clasp falls into its natural position, the hollow between the two breasts.

The V-shaped space between the breasts and the knot of the girdle is filled in our copy with a beautiful and characteristic series of folds; which, sloping alternately from either breast, gradually shorten as they draw near the opposite side, each fold turning up at the lower end for a short distance between two of the opposite folds. This arrangement, which is faintly suggested in the Varvakeion copy and Acropolis torso (Schreiber's I.), is only completely given in the Patras statuettes, and there can be little doubt that it approaches more nearly than any other to the form of the original. How feeble it can be when misunderstood can be seen, for instance, in the Ludovisi Antiochos statue (B), where these folds are collected by a kind of shorthand into

•

one crude semi-circle. In the Madrid (C) and Capitoline (E) torsoes, there is one fold here which looks like a reminiscence of the true arrangement, but in all the other copies one can see that the artist must have had in view a scheme similar to that of our copy, and which is found in the vase-paintings of the end of the fifth century.*

In the Patras statuette there are above the girdle, branching out each side, three large folds, which taper upward to the breasts, where they are lost; at their broadest width, that is to say, immediately above the girdle, they are hollowed—fluted, as it were—by the pressure of the girdle, for a short distance inwards; and this effect is carried out where they continue below the girdle. This characteristic effect,† which assists the eye in following the folds, is partially reproduced in one or other of nearly all the replicas, but in most of them its intention is entirely missed, and in none of them is it completely carried through; the Acropolis torso (I), an extremely perfunctory copy, does, indeed, reproduce the details after a fashion, but with an absolute lack of refinement or understanding.

The movement of the left leg, which has left so marked an effect upon the folds of the lower part of the chiton, does not, in any of the copies hitherto known, convey itself also to any part of the apoptygma; and yet one would expect that the shifting of the position of thigh and hip, consequent upon this movement, ought to make itself felt at least in the loose part of the apoptygma below the girdle. In most copies the general impression left on the eye by this part of the dress is that of a formal regular series of folds with no particular individuality to distinguish one from another. This remark particularly applies to the Minerve au Collier (F) and the Pighianus replica (G). In the Borghese torso (H), and even in the Acropolis torso (I), one sees traces of a break in the regularity of the folds on the left thigh, which, however, remains unexplained till we see, in the Patras copy, what was intended. Here the action of the thigh has suppressed two folds, leaving a suggestion of the modelling of the form beneath: immediately under the girdle these two folds join each other in an angle; and one feels that if the leg dropped back they would again separate into two

* The same system is shown also in the folds of the chest of the Demeter (F) of the East Pediment.

† Cf. the torso of Nyx in the East Pediment.

vertical folds. This scheme not only creates a pleasing variety in the otherwise monotonous ordering of the apoptygma, but, by carrying upward the suggestion of the action of the left leg, supplies the necessary continuity between apoptygma and chiton, which on the left side would otherwise be wanting.

In the lower part of the chiton of our copy the general scheme of folds is very much what we have already in the better replicas; between the two legs is one broad fold, forming, as it were, a kind of central pivot for the whole draped figure; two heavy folds descend vertically on the right foot, separated from each other and from the last-mentioned fold by deep under-cutting; the two deep shadows thus created are almost, but not quite, continuous with two upon the apoptygma, descending from the girdle-knot. The question has been raised, in connection with the other copies, as to how these folds terminated on the right foot; in some (B and H for instance) the folds terminate without apparent reason before reaching the foot; in F they lie bunched up on the instep. In our copy the folds begin to curve outward before reaching the foot, where they end apparently in a slightly wavy line; unfortunately, the foot is injured here, but there seems no doubt of the scheme being this, which is suggested in the Varvakeion copy, and appears in other works, as, for instance, the Caryatides of the Erechtheion.*

In our copy all the important folds are moulded with a slight longitudinal depression in the centre; while this does not unduly increase the number of vertical lines, it greatly reduces the hardness of effect which is produced, for instance, by the reproduction of the Ludovisi Antiochos statue (B): it attains the effect of a middle course, in fact, between that statue and the Minerve au Collier (F), with its bewildering multiplicity of folds, and there can be no doubt that here again we are nearest to the original.

The aegis of the Patras statuette, as compared with that of all the other known copies, is extremely narrow, so that the lower edge leaves nearly the whole of the breast uncovered; this detail is additional evidence of the early date of our copy; it is hardly necessary to point out the artistic advantage gained by an aegis so treated; the concave edges on either side of the Gorgoneion, each formed of a single snake,

* Cf. also the standing figure in the Metope of the North Side, *Br. Mus. Cat.*, 322.

are so adapted as to follow exactly, and so to define, the beautiful upper outline of the breasts. It can scarcely be a mere coincidence that precisely the same feature is found on the torso of Athene from the West Pediment of the Parthenon;* there, also, a scollop of the narrow aegis (which was possibly an invention of Pheidias) sweeps in a single curve around the upper surface of the right breast. The device is so simple and obvious as to seem of little moment; its real artistic importance is only seen when one compares the other replicas with ours; in most of these the aegis is palpably too wide; in the Wolkonsky statue (Schreiber's D) and the Borghese torso (H) there is some indication that the artist may have had before him an original of this type; but there is not one in which the beauty reflected by this part of the Patras statuette is so much as suggested.

In no part of the statuette is there so much variation among the copies as in the aegis. The best copies undoubtedly retain decided traces of the older form. Previously to the Parthenos it would appear that fashion ordained that each of the scollops of the edge should terminate in the forepart of a snake, forming a conventional fringe to the aegis. The later copies are characterised by an absolute freedom in this respect, when the object seems to be to endue each individual snake with as lifelike a character as possible. In our copy, the scollops terminate each in a spiral, formed of the forepart of a snake; the body passes along the edge to the next point, where it is clipped by the forepart of the next snake, but its tail lies flat on the surface of the aegis, and the tails thus form the suggestion of a conventional pattern.

The narrow form of aegis, which coincides with the form found in vase paintings subsequent to the Parthenon, and which is undoubtedly the form used by Pheidias for the Parthenos, is found only in our copy, and in the Capitoline torso (E), which, though only roughly executed, is charmingly simple in treatment. In all the other copies, a much wider form of aegis is found, the result being that the Gorgoneion, which necessarily forms the centre, though relatively increased in size, is widely separated from the lower edge with its row of snakes: in order

* Lange, in *Ath. Mitth.* vi., p. 86, notices what is wanting in the Varvakeion, but seems to regard the Pediment figure as a later stage. "Zwar ist noch nicht der Schritt zur rein decorativen schärpenartigen Aegis geschehen, den Phidias selbst an der Athena des westl. Parthenongiebels nachmals gethan hat."

to fill the empty space and to connect the edges clasped by the Gorgoneion with the lower snake-fringed edge, the artists of B, F, G add the tails of two snakes which proceed out of the crown of the Gorgoneion and branch out one on either side of it; the foreparts of these snakes are not shown: in H, even a step further is taken, and a similar pair of snakes issues from the ears of the Gorgoneion. Possibly these were suggested by the fact that in the original (as in our copy) the tails of the two central snakes of the lower edge turn up, one on each side of the Gorgoneion. Traces of these tails are to be found in most copies, especially in B and F. In D and E, they are reduced in scale out of all proportion, in order to get them into the confined space left by the exaggerated Gorgoneion. The Gorgoneion itself, in our copy, still retains traces of the archaic type, with the wide squat face of horror, the salient cheeks, flat nose, wrinkled forehead, and eyes drawn up to their widest at the inner angle.

The curves of the upper edge of the aegis, sweeping upwards in a single line on either side from Gorgoneion to shoulder, prepare the eye for the V-shaped fold, which the edge of the chiton makes at the centre of the neck. At the back, the aegis falls slightly lower than in front, and is simply treated, the scolloped edges of the front being replaced here by straighter and more formal lines; it is possible that the copyist may not have felt it necessary to follow his original so closely in his rendering of the back of his copy; it must, however, be said that in Pl. IX., *b*, full justice is hardly done to this part of the Patras figure; the treatment of the back suggests nothing of carelessness, but rather a broad simplicity of modelling, an effect which may well have been produced by Pheidias' own treatment of this portion of the Parthenos. The lower edge of the aegis at the back corresponds broadly to that of the front; that is to say, we have the coiled snake below each shoulder-blade, and the edge sloping up between them to a central angle Λ at the spine; from this point a single fold of the dress runs vertically to the girdle, with lateral folds sloping symmetrically inwards from the direction of the shoulders.

The surface of the aegis in our copy is left plain; possibly the scales were indicated in colour, which has perished. The edges are formed by the actual bodies of the snakes, which are so arranged that the head of each one links round the tail of the next; the tails lie in the aegis itself,

and the heads of two, now broken away, have been so arranged as to form a kind of pendant below the Gorgoneion. The form of the coils of these snakes, and also of the corresponding snake at the back of the figure, suggest that within them, in the original, may have stood pins which fastened the aegis in position. This fact may prove to be interesting in connection with the question as to the facilities which existed in the original for detaching the gold. It is generally accepted that the removable bullion of the statue (forming a reserve fund of the Athenian treasury) was fashioned into the drapery of the goddess.* But before the drapery could be removed, it was clearly necessary that the aegis should be first taken off, which, from its greater thickness, must have represented a large weight of gold. It is natural to suppose that some mechanical contrivance rendered this an easy matter; when once the Gorgoneion was removed, the two flaps would be separated; and it would be necessary for security to fasten each down with a nail. If, then, the front and back portions met in a joint on the shoulders like those of a cuirass, but here, of course, invisible, there would be no difficulty in removing the aegis in three pieces; the back portion, being nearly flat, would be, if necessary, detached in one piece, sliding down beneath the hair and crest of the helmet. No better place could be found for concealing the necessary pins than within the spiral coils of the snakes' necks.†

If we allow, then, that the aegis was probably fastened down with nails, it becomes interesting to note that on the back of the aegis of the Varvakeion copy there are two small but well-marked projections, one on each shoulder-blade, which suggest nothing so much as nails or pins. If these may be taken as representing some detail existing in the original, it may be that they formed some additional fastening which had become necessary by the time when the Varvakeion copy was made.

On the left shoulder are preserved the remains of two double tresses of hair, such as we know from the other examples must have existed in the original, hanging forward over the aegis.

* The simple arrangement of the Doric chiton, open down the entire right side, and without the addition of under chiton or himation, would doubtless greatly facilitate the task of detaching the drapery from the figure.

† Probably these would be the ἤλοι χρυσοί of the inscriptions, *c.g. C. I. A.* ii., 660, 9.

III.

On the left-hand side of the Parthenos stood her shield, resting on its edge, and supported by her left hand; and between the shield and the figure the Erichthonios snake. In the Varvakeion statuette these details are complete, and may probably be regarded as fairly accurate rendering of the original, as they were almost exactly reproduced in the Patras copy, so far as we can judge from the surviving portion. Here the snake is probably rearing up its head at about half the height of the shield; its body is folded in a complex series of twisting coils, somewhat in the form of a double figure of eight, and its tail, resting on the ground, passes round at the back nearly as far as the right side of the figure, with an effect which peculiarly enhances the suggestion of intimate association between the Parthenos and her *οἰκουρὸς ὄφης*.

In the Varvakeion figure the coils of the serpent are much more open, and the head of the snake comes nearly as high as the top of the shield. In our copy the body of the snake is unhappily wanting from the point at which the neck begins to strike upwards, but the coils are much more compressed, and the head of the animal can hardly have come much higher than the centre of the shield. This complex treatment of the coils necessarily presents much more difficulty to the artist, especially when working (as the copyist at any rate did) in the confined space between shield and figure; thus we obtain a further point of evidence in favour of the superiority of the Patras statuette. It may well have been the skill shown by Pheidias in surmounting the technical difficulties just referred to which make Pliny* select it as one of the points specially admired by connoisseurs . . . *periti mirantur et serpentem . . .*

The question as to the height of the snake's head is important in its bearing on that of the decoration of the interior of the shield. The sole direct allusion in ancient literature to that decoration is the statement of Pliny, that on the concave part Pheidias *caelavit deorum et*

* *N. H.* xxxvi., 19. We are not told in what material the snake was wrought. Since, however, Pliny specially mentions the Sphinx as the solitary exception (in bronze), we may presume that the snake was in the chryselephantine technique; a fact which would further enhance the difficulty of its construction.

gigantum dimicationes. It has been suggested* with great probability that the composition was not in relief, but painted, and Pliny's further reference (xxxv. 54) to a shield at Athens painted by Pheidias has been adduced as an additional argument for this conclusion.

On the other hand, H. L. Urlichs † finds this view untenable. He prefers to abide by the strict sense of Pliny's term *caelavit* as meaning carved in relief, and sets this assertion against the vagueness of *tradtur*, explaining the *clipeumque Athenis* as one of those shield-shaped votive paintings of which actual examples are known (*cf.* Paus. V. 10, 4); and relying upon the composition of the sentence, he takes *intus* and *Minervae* as referring to Panaenus alone.

As to the use of *tradtur* here, the obvious meaning is that Pliny was conveying some information which he had not himself verified, and of which he did not feel personally sure: there is absolutely no reason why we should saddle it, as Urlichs does, with the further meaning, "dass diese Ueberlieferung sonst nicht beglaubigt ist." And I cannot see why the tradition which knew that a shield at Athens had once been painted by Pheidias, should necessarily also know what that shield was. Nor need we follow Urlichs into the elaborate philological antitheses which lead him to reject this passage as having no bearing on the subject. This matter is really, when all is said and done, of minor importance, because, even if it be proved that Pheidias had once painted a votive shield of small interest, it does not follow that he did not also paint the interior of the Parthenos shield: so that the chief question after all turns on the other Pliny passage (xxxvi. 18); on that and on common sense. In this passage it is true that Pliny used the word *caelavit* of the decoration both on exterior and interior, and on the *soleae*; and that *caelare* is ordinarily used of carving in relief; but in a statement of this kind, where the writer is mentioning three cases of decoration, of which the first is sculpture in relief, it is only a very natural looseness of terms to allow the one word to cover the decoration which is not in relief, but painted; not to mention the great probability that Pliny himself may at the moment have forgotten that the interior was painted.

* Originally by Urlichs, *Chrestom. Plin.*; *cf.* Robert, *Arch. Märck.*, p. 24, and Furtwängler-Sellers, p. 45.

† In *Wochenschrift für kl. Phil.* 1895, p. 548; he is followed by Sellers and Jex-Blake, *The Elder Pliny's chapters*, p. 99 note.

For that painted it was, I have no doubt; if not, how comes it that none of the copies show reliefs on the interior side? After all, it is a question not so much of word-splitting as of common sense. What Greek artist would have dreamt of arming his patron goddess with so unpractical a weapon as a shield with interior projections such as would render its use impossible? From the universal practice of antiquity, it is clear that, if anything is put on the interior of a shield, it could only be some soft lining which would protect the arm when it was in use, just as we know the Greeks usually lined their helmets and greaves with felt (πίλος) or sponge. This lining is frequently shown on shields in vase paintings, and it is probable that wherever we find representations of decoration on the interior of a shield,* such decoration is intended to indicate, not painting or engraving direct on the metal, and still less relief, but the designs either of painting or textile which were usually employed for the decoration of such linings.

It may perhaps be urged that the shield of the Chryselephantine Parthenos was only a hieratic "property," and not necessarily a practical weapon. Apart from the artistic reasons which obviously militate against this view, there is also the statement of Pausanias (x. 34, 4) about a statue of Athena at Elateia in Phokis: ἔστι δὲ ἐσκευασμένον ὡς ἐς μάχην, καὶ ἐπείργασται τῇ ἀσπίδι τῶν Ἀθήνησι μίμημα ἐπὶ τῇ ἀσπίδι τῆς καλουμένης ὑπὸ Ἀθηναίων Παρθένου. This statue represented the goddess equipped for battle, that is to say, she must at any rate have had a shield copied from that of the Parthenos on her left arm. This is borne out by the coin-type of Elateia (*Br. Mus. Cat., Central Greece*, pl. iv. 26). Thus it is clear that the shield must have been one which would not look incongruous on the arm of a figure in action.

In asserting the practical impossibility of our finding in Greek art a shield decorated with reliefs on the interior, I may, perhaps, be met with the objection, as Mr. G. F. Hill reminds me, that shields with such decoration are actually found on coins. Thus, on the fourth-century coinage of the Locri Opuntii, a warrior (Ajax) is represented with a shield which has on the interior a snake, a lion, or a gryphon, which appears to be in relief. The snake is shown rising from a single coil in the lower part of the shield, with the head raised nearly to the upper edge. The arm of Ajax is passed through the ochanon and grasps the porpax,

* See the instances quoted in Furtwängler-Sellers, p. 45, note 4.

and the snake's body passes *between* it and the shield. If then this snake is in relief, what could be more awkward and unpracticable for the forearm passing over it?

In one instance (*B. M. Cat., Central Greece, No. 7*) not only does the snake's neck pass under the arm, but the entire coil of the body also passes beneath the broad diametrical band which forms the ochanon. It is therefore, I think, clear that the designs on the shields of this type are not intended to be considered as in relief; they are so represented on the coins, because the method of the coin-artist necessitated rendering all detail in this way. They are probably decoration, painted or woven on the lining of the shield; and in this connection it may be observed that on some of these coins there is shown a puckered edge within the rim of the shield which certainly suggests the edge of a lining.

Just as the design on the exterior of Athene's shield was in principle a highly elaborated shield-device (*ἐπίσημον*), such as might well have been found on a practical shield of the period; so that of the interior was the imitation of a decorated shield-lining, equally familiar to the spectator; and obviously the only method of rendering this on the chryselephantine shield, short of the insertion of actual leather or textile, would be painting. We know that the cult-statue, in a sense, summed up the motives set forth in the decoration of her shrine: and it may be more than a mere coincidence that the textile decoration chosen for the interior of her shield should be the battle of gods and giants, which was prescribed for the weaving into the peplos annually presented to her.

It is obvious, indeed, that the position of the shield of the Parthenos—nearly edgewise to the spectator, and allowing him to see the interior at an angle never greater than 45° —rendered painting, for its concave surface, much more appropriate than relief. Even so, it has been generally felt that the snake, covering the greater part of the interior as it does in the Varvakeion copy, would be a serious obstacle to any view whatever of the decoration of this part. Schreiber (*Athena Parthenos*, p. 83) considers that the Varvakeion copy must be unreliable on this point, and that we must suppose the shield of the original as set so much further from the figure as to leave the snake free and the interior surface of the shield clear.

But the evidence of the Patras copy, as compared with the others, tells in precisely the contrary sense; it is *à priori* more probable, as I have already suggested, that the copyist would tend to increase, rather than to diminish, the distance between shield and figure, in order to lessen the difficulty of working the snake. 'Take for instance the Varvakeion copy; here the space between shield and figure is at its widest, but the result is that the left arm would, if extended, hang nearly down to the knee. It is plain that the artist has been led into this want of proportion by his arbitrary widening of the space in question. In the Lenormant copy the arm is in better proportion, but still wrong, and an ugly strut (which can never have existed in the original) attaches it to the hip. On our statuette the left arm, preserved to a point half-way down the biceps, suggests a position much closer to the body (practically that of the Caryatides of the Erechtheion, for instance); and at the level where the hand would come is a rectangular joint, showing that the hand touched here; the direction of the remaining portion of shield, measured upwards, suggests the same point for its junction with the hand.

We are, therefore, brought to this conclusion: that the shield of the Parthenos probably stood close to the figure. If that be so, and the snake practically covered the interior surface of the shield, how was it possible for the Gigantomachia to be seen? I think the answer lies in the fact that the snake did not, in the original, cover more than the lower half of the shield, as I have shown is suggested by the Patras copy. Judging from the Varvakeion copy, the handles of the shield were arranged on a line drawn horizontally through the centre. If, as I suppose, the snake's head projected outwards on this same level, a natural tectonic division of the shield into two parts would result, of which the lower would be almost wholly covered by the complex coils of the snake, the upper would be left wholly free, and visible by spectators even to a fairly wide angle. That is to say, the decoration would be practically reserved for that half which, in a concave object seen from below, is best adapted to decoration.

We should thus have, for the painted battle of gods and giants, a semi-circular space such as would be regarded by an artist of Pheidias' time as peculiarly appropriate to this very subject. The scene would doubtless be handled somewhat as that on the contemporary Athenian vase-

fragment published in *Mon. Ined.*, ix. 6. The rim of the upper half of the shield would represent the arch of heaven, within which the giants would be shown piling up rocks on a mountain-side.* The figure of Gaia in the vase-picture is placed at the right-hand lower angle, a position which she may well have occupied on the shield, as being thus nearest to the spectator, and, from the point of view of perspective, at the bottom of the design. It is true that on the vase the gods are represented above the arch of heaven; but I think we may regard this as a detail in which the artist would be guided according to the exigencies of the space he had to fill. The vase-painter, having what is practically a rectangular space to fill, finds it convenient to square the semicircle of the heaven in his composition with the figures of the gods. The painter of the shield is forced to bring his gods within the semicircle. That such a scheme was regarded in antiquity as permissible we see for instance from the shield-form relief of the Niobides, in the British Museum, where the figures of Apollo and Artemis are placed on the topmost levels of the mountain-side on which the Niobides stand.†

The vase-painting just quoted gives us also a further parallel; the interior of a shield carried by one of the giants taking part in the combat is itself decorated with a Gigantomachia, in which the tectonic division of the shield into two equal portions by the handles is actually represented. Here the gods fight in one half, the giants in the other; but, of course, in this instance, there is not the structural necessity which existed in the case of the Parthenos for leaving one half of the interior of the shield undecorated.

I had written so far when I chanced upon a curious little discovery, which I venture to hope may be regarded as settling the question once for all. I suppose that if an acknowledged copy of the Parthenos shield can be produced, which has the known relief in the exterior and a painted scene on the interior, all reasonable doubt would at once be removed.

* It is evident, from the existing copies, that the scene of the Amazonomachia on the exterior of the shield was laid on a mountain-side (the slope of the Acropolis), and thus the necessary balance would be struck between the two sides.

† Cf. Furtwängler-Sellers, pp. 44, 45, where the Pheidian character of this relief is justly pointed out.

It is curious to think that such a copy has been in the British Museum, and well known since 1865. In publishing the Strangford shield (*Brit. Mus. Cat. Sculpture*, i. No. 302) in that year,* Conze remarked upon the admirable condition of the surface, on which the traces of the original colour are in many parts still quite distinct. While recently examining this monument once more, it occurred to me that if the interior had ever been painted, possibly some traces of the colour might there also still be found; and such is actually the case; by merely turning the shield round, any one may see on the interior the undoubted remains of a painted composition.

In the centre of the circle is carved the ochanon, the broad elbow handle of the shield; in the part which is preserved of the semicircle above this the colours are a good deal worn; but enough remains to show that figures have been painted here; the lower semicircle appears to be divided into two sections by a vertical black line from the ochanon to the rim. In the right-hand section (which in the scheme I have suggested would be concealed by the snake) nothing can be made out; but in the left-hand section is a bearded figure standing on a groundwork of rocks, bending forward to right, and lifting in both hands what is apparently a large rock. The hair appears to be shaggy, and the attitude is one very appropriate to a giant in a gigantomachia; it is almost identical with that of the young giant in the vase painting already quoted (*Mon. Ined.*, ix. 6), who leans forward lifting a rock in front of the helmeted warrior on the left of the scene. I think, therefore, that we may confidently recognise in the composition a rendering of Pliny's *deorum et gigantum dimicationes*; and may safely disregard in future any objection to a painted interior based on the use of the word *caclavit*.

This figure is so distinct that one can only marvel that it has hitherto escaped notice. It is about 0·15 m. long, that is to say, on exactly the same scale as the figures in relief on the exterior. It is laid in in a deep red outline, which appears to have been filled in with some pigment or pigments which have perished. The same system has been adopted for the rock which the giant is lifting, while the groundwork of rocks on which he stands seems to be washed in in silhouette of a reddish brown. †

* *Arch. Zeit.*, 1865, p. 33, Pl. 196-7. † I hope to be able shortly to publish a coloured fac-simile.

So far as it goes, the remains of this painting bear out the suggestions above made for the arrangement of the interior composition of the original shield; viz., that the part covered by the snake would be left unpainted, and that the combat really occupied only the upper semi-circle and the part behind the snake's neck.

IV.

In our statuette, rather more than two-thirds of the shield, with a corresponding portion of the snake, are broken away. But, most fortunately, enough is preserved to show us an important part of the decoration on the exterior (Fig. 1). This consists of two nearly com-

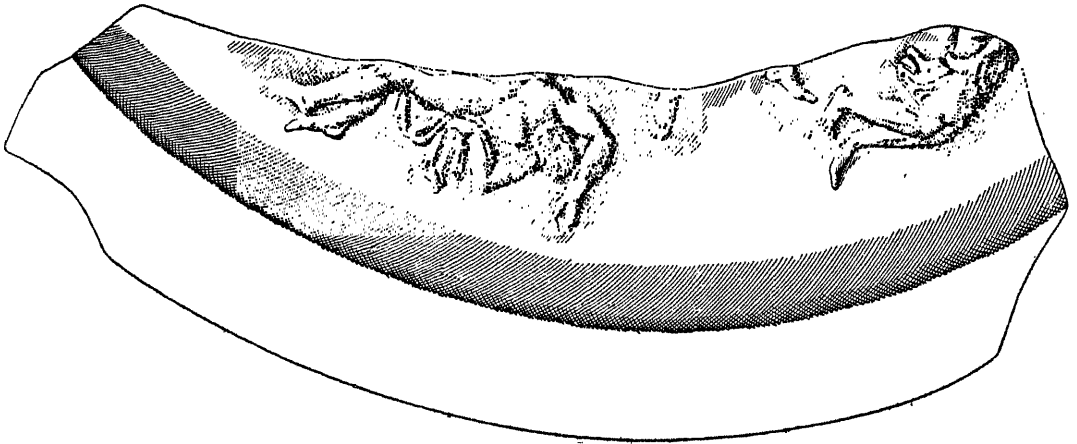

FIG. 1.—FRAGMENT OF SHIELD OF THE PATRAS STATUE OF ATHENA PARTHENOS (Scale, $\frac{1}{2}$).

plete figures in relief, and the feet of a third, which evidently belong to a battle of Greeks and Amazons, similar to that which is shown on the Strangford shield, on the Vatican and the Capitoline fragments, and which is very roughly indicated in the shield of the Lenormant statuette.

The accompanying drawing of our fragment, in half scale, is intended rather as a diagram of the figures than as an indication of their artistic quality; which can only be estimated by a comparison of them with the reliefs of the other copies and with analogous reliefs, such as those of the Niobide shield already mentioned.

The figures are sculptured with great delicacy and freedom, and in this respect are immeasurably superior to those of any of the existing replicas. All the three can be recognised from the corresponding figures in the Strangford and Lenormant copies.* The one on the left of our fragment corresponds to the dead Amazon, who in the Strangford shield lies stretched below the Greek with face concealed, the supposed figure of Pericles. This group clearly was intended to form the lower pivot, as it were, of the composition. In the other replicas the Pericles figure comes immediately below the Gorgoneion, standing over the dead Amazon; and from this group the figures on either side move away. Of the figures in the lower plane, only the four grouped under the Gorgoneion are Greeks; they are confronted with five dead or wounded Amazons. All the remaining figures in the higher plane with one exception appear to be Amazons clambering up the mountain-side. In our copy the surface of the body is unhappily slightly injured; for this reason it is difficult to say whether the artist has designed it for an Amazon, as is undoubtedly the case in the other replicas. At first sight the body appears to be nude, and the fact that it lies on drapery would seem to be against the theory of an Amazon. In the Strangford shield there is no drapery under the figure, which wears a short chiton, leaving the right breast free. In our copy, however, so far as one may judge from a cast, I think I can trace on the left shoulder the line of the chiton, in which case the drapery below the thigh may also be part of the same dress; but the rest of the drapery, hanging from under the left hand in a "swallow-tail" scheme, cannot belong to a chiton. On the whole, the figure of an Amazon is required here, and I think we may take this as an Amazon.

The Strangford figure lies in a somewhat constrained attitude, as if asleep, with both legs bent up at an angle, and by no means suggestive of death; and the left arm is extended, as if she were lying on it. There is, moreover, in the figures around her, a confused tangle of legs which can hardly have existed in the original. These faults are certainly due to the fact that the copyist, in that instance, had adopted a totally disproportionate scale for his figures. With a diameter of only 0.482 m., he has made his figures no less than 0.15 m. long, and the

* The Vatican and Capitoline fragments do not include this part of the design.

compression of the design thus rendered necessary is seen in every line of the composition.

In our copy, with a diameter* of almost the same size (0·42 m.), the figures are only 0·08 m. long, or very little more than half the size of those on the Strangford shield; and the result is an immense gain in freedom and artistic fitness. The general relation of the figures to the field is, broadly speaking, the same as in the Niobide relief. The dead figure is here shown in what must have been the original pose, with the legs not cramped, but relaxed in the beautiful crossed scheme which Pheidias used, for instance, for some of the figures in the East Frieze (*e.g.*, Michaelis, *Parthenon*, Nos. 37, 39). The head and right arm hang downwards, as if this part of the figure had fallen forward over the edge of a rock; the left arm hangs loose, but is kept from falling downwards by the weight of the body resting on the hand; by this device the artist conveys the impression that the muscles are relaxed, and at the same time avoids the awkward effect which would be caused by the introduction of a vertical line extending to the edge of the field at this point. The general resemblance of this figure to the dead Niobide on the shield † is at once evident, as also is the parallel use the artist has there made of the lines of drapery composing with the relaxed and flowing lines of the human form. But a still more striking parallel is obtained if we compare the dead figure of a Lapith in a metope of the Parthenon (*Br. Mus. Cat. Sculp.*, 317). This figure repeats almost line for line the forms of the dead figure in our copy, except only that in the more confined space of the metope, the right leg is slightly bent; the body lies within the true plane of the scene, but the head and arms, with the drapery below the body, seem to have hung forward over the border of the design, precisely as is the case with our figure. Furtwängler is of opinion (*op. cit.*, p. 46) that in this class of metope the influence of Pheidias had begun to make itself felt, either directly in his own work upon them, or indirectly through the other artists employed; whichever way we regard it, it is highly probable that the figures on the metope and the shield were closely

* In both cases, the measurements are those of the actual field of the reliefs, that is, the shield minus its rim.

† Furtwängler-Sellers, p. 44, Fig. 70. It is also almost exactly repeated in the fine Vienna sarcophagus, Robert, II., xxvii, 68A.

related, and that our copy may be considered as very faithful to the original.

In both the Strangford and Lenormant copies of the shield there is shown on the right of the dead Amazon, a group of an Amazon who has fallen on her knees to the right, behind whom is a Greek warrior who has seized her by the hair with his left hand, drawing back his sword in his right to deal her a final stroke. Of these figures our fragment gives the feet of the Greek, and the body, nearly from the shoulders, of the Amazon.* In the Strangford copy the feet of the warrior are placed with a very unfortunate effect, one on the stomach of the dead Amazon, the other on the right leg of his immediate opponent, so that he appears to stride from one to the other with a very uncomfortable foothold. In the Lenormant copy, the right leg of the Greek is nearly in the same position as is indicated in our fragment, but is still not far enough away from the dead Amazon; his left leg has become lost to view behind the falling Amazon. These difficulties are doubtless due to the compression of this part of the scene consequent on the error of scale already mentioned; the same cause is probably responsible for the distortion of the higher planes; thus, the Greek and Amazon who should be fighting immediately above this group, have become, in the miscalculated spacing, entirely separated, so that their respective actions are ridiculous.

Our fragment undoubtedly gives us the figures for the first time in something like their true relative positions. The Amazon is not (as would appear from the Strangford copy) crawling away to the right, but falling or leaping from the hill-side, when she is probably caught by the hair; the movement of her drapery, which is only faintly suggested in the Strangford copy, shows that she is not running, nor yet still; the bent legs, with feet close together, but resting on nothing, must certainly mean that she is falling downwards to the right; a variation of attitude which forms a charming contrast with, instead of tamely repeating, the position of the Amazon immediately above her.

The composition of this group, as a type in art, has a somewhat

* This figure appears to wear the usual high boots, but the condition of the surface does not leave this quite clear. Probably such details were largely here, as in the Strangford shield, indicated in colour.

special interest. The contrast of the strong, erect, self-contained man, and the fleeing woman on her knees, drawn backward by her long hair, so that all the softer curves of her feminine form are expressed, is the archetype for all classical rendering of combat between the sexes. Created probably originally for the Ajax-Cassandra scene, it became obviously the type *par excellence* for Greek and Amazon.* Pheidias uses it again in the Parthenon; once more it is a metope which supplies the parallel; with but slight variation the group is identically reproduced on metope No. 14 of the West side (Michaelis, *Parthenon*, Pl. 5, xiv.). From this time forward it becomes almost constant for Greek renderings of the Amazonomachia; in the Mausoleum frieze it occurs twice (slabs 3, 6), and in the Phigaleian frieze no less than five times (slabs 532, 534, 535, 536, 538).

V.

Below the edge of the shield is a support with vertical ends, but of which the upper surface fits into the curve of the shield. A similar support occurs in the Lenormant and Varvakeion copies,† presenting almost exactly the same relative form and size. In copies of these varying dimensions there is no apparent necessity for such a support; nor is it likely that three independent copyists would all have hit upon one of exactly the same relative size and form. It is therefore reasonable to conclude that we have here some feature which existed in the chryselephantine statue of Pheidias. Why was it introduced?

In the first place, a disk resting on its edge, and therefore touching the ground with only a very small portion of its circumference, would present considerable difficulties of reproduction in the chryselephantine technique. Besides, the ordinary Argolic buckler is not so large that when resting on its edge on the ground it would reach to the height of its wearer's hand, unless the wearer stooped towards it.‡ The intro-

* In the Louvre gigantomachia vase (*Mon. Grecs*, 1875, Pl. 1-2), which is generally admitted to show marked Pheidian influences, it occurs twice; in each case here it is a deity who seizes a giant by the hair: it had not yet become stereotyped for Greek and Amazon. The same vase offers an interesting parallel in the position of the legs of the wounded Amazon.

† The Vatican and Capitoline fragments do not include the lower portion; the Strangford shield has probably had the same support, but the entire rim seems to have been tooled away in order to leave a symmetrical edge, which is so mounted that the character of the fracture cannot be seen.

‡ Cf. for instance, the r.f. krater in the British Museum (*Cat.* iii., E. 498), where an Athena of the Pheidian type stands with shield resting on its edge on the plinth of the tripod.

duction of some such support, therefore, was necessary; and introduced, it obviated the necessity of the very difficult task (which would otherwise have been imposed on the artist) of working up the outer surface of the snake's body in a position where it would be very difficult to get at it. Lastly, it was necessary to heighten the shield in order that the spectator might command an uninterrupted view of the paintings on the upper part of the interior. Schneider (*op. cit.* p. 624) remarks on this necessity, and proposes to open out the space between the snake and the shield; such a plan, however, would scarcely have effected the result required, neither is it warranted by any of the existing copies.

If now we admit that the Parthenos of Pheidias had a support of this character for her shield, it is evident that it must have presented a marked feature in the general design, and as such, it must have been decorated in some way; the more so, as it would have stood nearly on the level of the spectator's eye, and in close juxtaposition to the elaborate reliefs of the shield. That such supports were usually decorated we know from more than one example. Conze, in *Philologus*, xvii. p. 368, refers to a statue in the Villa Borghese, representing Athena with shield and snake, in explanation of the word ἄνθεμον, which occurs in three inscriptions. In one of these inscriptions the ἄνθεμον is described as being ὑπὸ τῆν ἀσπίδα, and as being fastened in its place with lead; and from the context it is clear that the word must mean just such a support for a shield as we are discussing.

The Villa Borghese statue has the ἄνθεμον carved in the form of a flower; in a statue found at Civita Lavinia,* the ἄνθεμον takes the form of a couching sphinx. This last instance led Lange† to suggest a new reading for the difficult Pliny passage (xxxvi. 19), *Sub ipsa cuspide aeream Sphingem*. In place of *cuspide*, he proposes to read *aspide*, and would assign to the chryselephantine shield an ἄνθεμον in the form of a Sphinx. Apart from the improbability that Pliny would have used *aspide* in a sense only found in the latest Latin, and that he should have used it, moreover, in a passage where the word *scutum* (already employed), would have done just as well, I think Lange's view is untenable for other reasons; the notion of a Sphinx (or a flower) under a shield would be out of keeping with the artistic ideas of the fifth

* *Bull. dell' Inst.*, 1867, p. 142.

† *Ath. Mitth.* vi., p. 88, note 1.

century; and it is fairly certain that if a Sphinx, or any other object in the round had been under the shield of the original, it would have been reproduced in one or other of the copies. Of all the various readings proposed for this much-debated passage, there is not one which seems any more satisfactory than another. As, however, it seems to me extremely unlikely that Pheidias would have introduced more than one Sphinx into his composition, I can only think that Pliny, whether intentionally or not, is alluding here to the Sphinx which we know supported the crest of the helmet.*

Although, therefore, the above instances prove nothing as to the *form* of the ἄνθεμον, they certainly increase the probability that it was decorated in some way; its form, indeed, we know already from the combined testimony of all the copies, and what we should expect from its appearance would be a relief or a painted composition.

If now we turn to the passage in Pliny (xxxvi. 18), we shall find that he devotes one sentence to a description of the decoration of (i) the exterior of the shield, (ii) the interior of the shield, and (iii) the *soleae*, and adds *adeo momenta omnia capacia artis illi fuere*. He then goes on to describe (iv) the decoration of the base. As it is generally understood, the sentence beginning *adeo* seems out of place; for why, if it includes (iii), does it not also include (iv)? If *soleae* here really means "sandals," the fact that Pheidias decorated the base with *dii xx numero* is surely quite as relevant a *momentum capax artis* as the fact that he decorated the shield and sandals; and it is difficult to see why, to point his remark, Pliny should tack the sandals on to the two parts of the shield.

Is it possible that the whole theory of a decoration of the sandals is based on a misconception? and that the combats of Lapiths and Centaurs were really on the ἄνθεμον of the shield? In view of the actual existence of a colossal marble foot in Rome† which has a frieze carved on the edge of the sole, I hardly dare venture to make the suggestion; and yet I cannot but feel that it has much in its favour. Of

* The reading which seems to be required is *sub ipsa cassidis crista*, but the MSS. of course forbid this. Is it possible Pliny could have misread *λόγχη* for *λόφος* in his original source?

† Figured in *Bull. Munic.* i., Pl. 1, late in style. In the passage of Themistios, or. 25, p. 309 D (Michaelis, *Parthenon*, p. 269, No. 41), *οὐδὲ εἰς τὴν κρηπίδα τῆς θεοῦ μόνην ὀλίγου χρόνου καὶ πόνου προσδεηθῆναι*, the word *κρηπίς* probably implies the base of the statue: hence its use in the singular.

the two spaces offered for decoration, unquestionably the more important is the support of the shield, especially when we remember that the spectator was prevented by a barrier from approaching near the front of the Parthenos, and could scarcely have been able to see reliefs of so small a size as they must have been if they were on the edge of the soles of the sandals.

If, however, the entire sentence of Pliny could be taken as referring to the shield, a great deal of the difficulty would disappear. For this purpose it is necessary to take *soleae*, in the passage before us, as the equivalent of *ἀνθεμον*; that such a meaning is possible appears from a passage in Festus,* where the word implies the solid support on which a wattle wall is erected. The passage would then read as follows:—“I shall cite those minute details . . . instance her shield; on the convex face he represented the battle of the Amazons, on the concave surface the conflicts of gods and giants, while on the support were the conflicts of Lapiths and Centaurs, so skilful was he in adapting every possible space as a field for his art.” Taken in this way, the construction is more natural, and the whole sentence gains in force: the meaning intended being broadly . . . “Every portion of the shield, the outside, inside, and support (i.e., *momenta omnia*) were considered by Pheidias as susceptible of decoration.”

Moreover, if we consider the character of the space offered by this *ἀνθεμον*, which is that of a surface narrowest in the centre and rising outwards on either side—like the two halves of a bisected pediment, joined at the angles—we shall recognise that a battle of Centaurs and Lapiths would be admirably adapted to fill it. The equine body of the Centaur, which at its natural level is lower than the human head, but which, when rearing up, can be made to occupy a much higher level, gives exactly the scale of variations which would be necessary for two sloping fields such as these.

Whether this design was painted or in relief the Pliny passage does not allow us to decide, since the word *caelavit*, there used for all three subjects, is now shown to cover both painting and relief. Probably, as the support was a merely subsidiary part of the design, and it was

* Ed. Müller, p. 301. Possibly Pliny was misled by the double meaning of which the word *κηπις* in his original text is susceptible. If he was not familiar with its sense as = *ἀνθεμον*, he would naturally translate it as = *soleae*.

necessary to mark strongly the contrast between it and the shield with reliefs resting upon it, the Centauromachia was painted; and this is the reason why, in the copies which have come down to us, no trace has yet been found of any design on the support. On the other hand, in more than one of the copies of the Parthenos (Schreiber's B and H), traces of the decoration on the sole of the sandal are preserved; and this is clearly shown to be (what, after all, is the most suitable decoration for such a purpose) a mere strap ornament. When we consider that neither of the sandals is completely seen, each being partially cut off by the drapery, the argument in favour of a merely decorative pattern for the soles is strengthened; a figure subject requires a well-defined tectonic space; and a Greek artist would not have committed the error of creating a frieze of which only a part was visible, but the greater part was left to the imagination as running under the drapery of the foot. For an interrupted field like this, it is necessary that the decoration shall be a conventional and self-repeating one; this is one of the first rudiments of the law of applied design.

VI.

It is noticeable that in the Patras copy the base is complete; and here, at least, there can never have been room for a support for the right hand such as exists in the Varvakeion copy. On the other hand, there is no attempt here to indicate any of the decoration which we know existed on the base of the original, and which is indicated in the Pergamene base (*Fahrbuch*, 1890, p. 114, fig. 9) and in the Lenormant copy. Consequently, we must conclude that the base of the Patras figure is a mere conventional plinth, and, in the absence of the right arm, we shall not be justified in deducing any conclusion from it as to the original. Moreover, even if there had been a support for the chryselephantine right arm, an olive tree, as Mr. A. S. Murray suggests, or a column, it would not necessarily be reproduced in a copy of this size, for which the mechanical difficulties would not be felt in the same degree. There is no reason, for instance, why the Nike should retain the same relative proportions as in the original; in the Payne-Knight bronze copy of the Kanachos Apollo the deer on the hand is reduced to minute proportions; and although the clumsy copyist of

the Varvakeion Athene finds a support necessary, there is no reason why the skilful artist of the Patras figure should not have been independent of any such device.

In the bare possibility of any light being thrown on the base of the original, every detail deserves to be recorded: it may therefore be worth noting that in both the Varvakeion and Patras copies, the base has a peculiar feature; whereas the right-hand side is square with front and back, the left-hand side is not so; in both copies the left-hand corner of the base at the back seems to be designedly cut away. This may be a mere coincidence, or possibly simply due to the position in which each copy was intended to stand (in a niche or some similarly confined space). In any case the fact is probably not significant, seeing that in neither base has an attempt been made to follow the lines of the original.

VII.

To attempt to assign an exact date to the copy of a great work is in the highest degree difficult, if not impossible. All that one can do is to point out, as I have tried to do, for the Patras copy, the reasons for estimating its position in relation to the original and to other copies. Judged from this standpoint, I have no hesitation in claiming for the Patras copy, that it is at once the earliest in point of date and the most faithful of those which have come down to us. That it is Greek work of a date previous to the Roman period I think no one will deny: and it is even possible that the circumstance of its provenance may help us to a more precise indication of its date.

Pausanias (vii. 18, 5) says that on the occasion of the invasion of the Gauls the people of Patras crossed over to help the Ætoliens, but in consequence of the great reverses they sustained and of the poverty by which most of them were oppressed, all but a few of the inhabitants of the town were led to abandon Patras and dispersed throughout the country; and that it was not until the time of Augustus that they were once more collected and the town repopulated. Polybius (xl. 3) refers to the same historical event, which must have taken place in 279 B.C.* During this intermediate stage of suspended existence we can hardly

* Frazier, *Pausanias* iv., p. 143.

suppose the town to have been entirely deserted; in fact, we have evidence in Polybius and Livy that it was, from its position, a place of call for fleets and armies; but it is evident from the measures taken by Augustus that it had ceased to have any prosperity. It is therefore hardly likely that we can assign our statuette to any date subsequent to 279 B.C.

Now we have in the British Museum a bronze statuette of Marsyas (*Cat. Bronzes*, No. 269) which was found at Patras,* and which, like the one under discussion, is probably also the copy of a masterpiece which existed at Athens. This statuette is generally assigned to the fourth century B.C. And it looks as if the same circumstances which led to the one copy being made, may equally have led to the making and setting up in Patras of the other.

That the worship of Athene was popular in Patras we see from Pausanias (vii. 20), who mentions two sanctuaries and a statue of the goddess there. Beside the temple of Panachæan Athene, within the enclosure of Laphria, whose chryselephantine statue is probably identified on the coins, there was also an "image of Athene in the open air," near the grave of Patreus, within the market-place; and outside the market-place a sanctuary of Athene with a statue of the goddess in ivory and gold; it is conceivable that this last may have been a type borrowed from the statue by Pheidias at Athens.

CECIL SMITH.

[It is greatly to be hoped that the Greek Government may be induced to prosecute some further researches on the site where this statuette was found. In November, 1896, immediately after our discovery of it, I offered on behalf of the British School to make an excavation with the object of ascertaining whether, as is extremely possible, other fragments of it may not still be in the soil there. Mr. Cavvadias declined the proposal, on the excellent ground, as I understood, that the Government would itself undertake the task; it may be that they have already done so; but I fear that is not the case.]

* Found in the course of some drainage works by a French Company. See Rayet, *Mon. de l'Art*, text to Pl. 34.

ON THREE BRONZE STATUETTES.

(PLATE X.)

THE importance of the bronze statuette as a document for the reconstruction of early sculptural types and of the different phases through which Greek art passed is apt to be overlooked, but there is reason to suppose that the main lines of an antique conception are more likely to be preserved in it than on a marble adaptation made after a lapse of several centuries. Many of the most celebrated Greek statues were made for temples. A large proportion of the bronzes were votive offerings, and roughly reproduce a local cultus-statue, where any serious variation from the original design would not be tolerated; the difference consisting in the suppression of detail, not in the addition of it, as in a marble copy. Further, the mechanical method by which a bronze is reproduced effectually prevents the intrusion of the worker's personality, so that a second century cast from a fifth century mould is practically contemporary with the original design. The three bronzes which form the subject of the present article bear witness to the historical value of the class to which they belong. They represent three periods in the creation, the maturity, and the decadence of one particular class of figure, the nude male type of the "Argive" school.

The provenance of the Zeus* (Plate X., Fig. 1) is not known, but from the colour of the patina and the discovery of three similar figures during the excavations at Olympia, we may conjecture that it too was found there. In discussing the Olympian bronzes, Professor Furtwängler refers them to an original created circa B.C. 500,† and in another

* Collection of Monsieur Michel Cambanis, Athens. Height 0,126 m. Patina green.

† *Olympia*, vol. iv. pp. 18, 19. Nos. 43, 43A, and 45, and Plate.

connection* names as this original the Zeus Ithomatas of Hagelaïdas, the Argive master with whose name he connects the following canon† of attitude and proportions: "The body is supported on the left leg, the right leg is slightly bent at ease, but the foot is flat on the ground. The right arm hangs somewhat quietly down, the left is in action, the head is turned to the left and inclined, the body has a broad, firm pose, owing to the leg at ease being set well to the side." This canon undoubtedly contains the germ of our statuette type, but the great advance in vigour makes it difficult to assign both the creation and its development to one and the same artist. We have, however, some indirect evidence which tends to show that while the canon was the common property of the archaic Argive school, its development was the inspiration of Hagelaïdas. Further, it is still a disputed point whether his Zeus Ithomatas was a bearded or a beardless figure. The whole question turns on whether the coin type of a silver Messenian tetradrachm ‡ does or does not reproduce the Zeus of Hagelaïdas, and on the whole the balance of probability is against the attribution, because Hagelaïdas seems to have had a marked preference for youthful beardless figures.

Several coins of Aegion § bear a Zeus figure which differs only from our statuette in being *beardless* and in the pose of the eagle, and Pausanias || states that he saw there two cultus-statues of a youthful Zeus, the one a Zeus Soter (τὸ δὲ οὐκ ἔχον πω γένεια) and another the work of Hagelaïdas the Argive, near which stood a beardless Herakles by the same master (Ζεὺς τε ἠλικίαν παῖς, καὶ Ἡρακλῆς, οὐδὲ οὗτος ἔχων πω γένεια) and also a bearded Zeus which looked less archaic than the other.

The Aegion coin-type undoubtedly represents a cultus-statue, as it stands on a decorated plinth; one example bears the legend ΑΙΓΕΩΝ ΠΑΙΣ, another, ΖΕΥΣ followed by an illegible word. We therefore have to choose between the Zeus Soter and the Hagelaïdas Zeus, and the latter, as the work of a famous artist, was the more likely to be selected for a coin type under the Roman rule (coins dated B.C. 46-31 and 130 A.D.).

* 50th Berlin Winckelmannsfest-Programm, p. 130.

† *Masterpieces of Greek Sculpture*, p. 49.

‡ *Catalogue of Peloponnesian Coins in the British Museum*, Plate XXII., 7, p. 110; fourth century.

§ *Ibid.*, Pl. IV., 12, 14, 17.

|| *Paus.*, VII., 23, 9; 24, 4.

Pausanias* mentions the Zeus Ithomatas without comment, but refers to a Messenian legend about the youth and nurture of the god, which is in itself a strong argument that the local cultus-statue represented a youthful Zeus, and would explain the selection of Hagelaïdas to execute it. Thus, of three works assigned to this master, two are expressly stated to have been beardless, and the absence of any special comment on the third rather shows that it did not differ in this respect from the others.

It is also worthy of note that archaic coin types † of Poseidonia and Caulonia show beardless figures of Poseidon and Apollo, which in attitude and action exactly reproduce the Aegion type. Now our knowledge of the early work of Hagelaïdas is gained from the bases of three athlete statues, made by him for Olympian victors between B.C. 520-511. These were, of course, youthful beardless figures, and the footmarks prove that in attitude they conformed closely to the (so-called) canon of Hagelaïdas. A young sculptor would naturally require time to break away from the traditions of his school, but the bases present no argument against his having done so by B.C. 500, while his experience as a sculptor of epinikian statues, combined with the statements of Pausanias and the evidence of coin types, makes it possible that his great fame rested on his adaptation of an intensified athlete type, in vigorous motion, to the representation of the greater divinities. Such a type was certainly created about B.C. 500, and it is equally certain that though it had a brief *succès de scandale*, its lease of life was very short.

It seems unlikely that an artist who had evolved this novelty would consent to modify it by substituting a bearded for a beardless head. Such a variation is characteristic rather of a pupil; but the type exists, not only in our statuette and in the Messenian tetradrachm quoted above, but in a series of coins which prove that it was borrowed from a famous work, and which also approximately fix the date of its creation. The most perfect copy of the statuette is found in imperial coins belonging to the Carian cities of Tabae and Attuda,‡ which faithfully reproduce not only the slanting profile and archaically-dressed hair,

* *Ibid.*, IV. 33, 2.

† Head: *Guide to the Coins of the Ancients*, Pl. VII. Nos. 12, 13; VIII. 1, 17.

‡ *B. M. Cat., Coins of Caria*, Pl. XXV. 8; X. 16.

but the peculiar pose of the eagle. The type, slightly varied by the addition of a chlamys, is found on a coin from Zancle,* the importance of which to us lies in the legend **ZANKAON**, a name not applied to the city later than B.C. 476.† The last coin is a Roman denarius of B.C. 49, struck under the consulship of L. Cornelius Lentulus and C. Claudius Marcellus.‡ The special appositeness of the type would lie in the fact that an earlier Marcellus conquered Sicily, and that in B.C. 466 the Syracusans set up a statue of Zeus Eleutherios.§ The main conception is the same, but the left foot rests on an altar. These coin types prove that a bearded Zeus, differing only in that respect from the beardless one attributed to Hagelaïdas, was designed before B.C. 476, was still sufficiently novel to be used for an important Syracusan statue in B.C. 466, and famous enough to be chosen as a coin-type by two Carian townships in imperial times. I should, therefore, assign it to circa B.C. 480, about 25 years after the beardless type. The wide diffusion of the type shows that the original was erected in some place where it would enjoy more than a local celebrity, and the discovery of three replicas of the type at Olympia points to that place as its home. Pausanias || mentions a small statue of Zeus “τὴν ἑτέραν τῶν χειρῶν προτείνον,” but the reference is too vague to serve as the basis of a theory, while the colossal marble torso (a Roman copy of archaic work) which has been found at Olympia is too much damaged to throw any light on the subject. We cannot even conjecture to whom the adaptation should be ascribed. It seems unlikely that Hagelaïdas made the change, especially as by B.C. 480 he must have been at least 60 years of age, and we know that the Zeus of Dionysios, his most famous pupil, was beardless.¶

The vigorous realism of the type, as shown in the bronze, coupled though it is with anatomical and technical ignorance, is characteristic of a school which sought to convey by vigour what later sculptors suggested by beauty. This stage is represented by our second statuette** (Plate X., Fig. 2), a Hermes of fourth-century work, which illus-

* *Num. Chron.*, 1883, p. 168.

† See Head, *loc. cit.* and *Paus.*, vi. 2, 10.

‡ Head, *Guide*, lxvi. 16.

§ *Diod. Sic.*, xi. 72, 2; see also *Masterpieces*, p. 218.

|| *Paus.*, v. 24, 1.

¶ *Ibid.*, v. 24, 1; 26, 3.

** Misthos Collection, now in the Central Museum at Athens. Reg. No. 5,456; height 0.15 m.; patina, dark green.

trates the great tendency of that age, a striving after beauty for its own sake, which led on the one hand to the adoption of an ephebe type for Hermes, and on the other to eclecticism in style.

The archaic Hermes is very generally a bearded man, the herald of Zeus, swift as befits a diligent messenger, and therefore strong. His strength marked him out as a fitting protector for the palæstra, and in due course led to the universal adoption of the ephebe type, not merely for Hermes, but for all other presentments of him.

The Argive type, as amended by Polykleitos, underlies our bronze, especially in so far as concerns the attitude with its characteristic *dehanchement* and the powerful frame-work of the figure, but the face is of Attic type, full and fleshy, with a very small mouth, round chin, heavy eyelids, and eyes set close together. The hair is dressed in little curls, the drapery is Attic. Thus we have, not the undiluted canon of one school with all its strong and weak points, but a combination of the most admired features of two—Peloponnesian beauty of form, Attic beauty of expression. The combination is noted in a considerable number of works, *e.g.*, an Argive grave relief* belonging to the middle of the fourth century, but the most important is a life-sized marble Hermes found near Troezen, and now in the Central Museum at Athens.† The statue is of poor Roman workmanship, but shows the same ephebe Hermes type and mixture of schools as our bronze. It also suggests a restoration for the missing right arm. The bronze is sufficiently identified as Hermes by the petasos, the remains of the caduceus in the left hand, and the winged feet; but by the help of the statue and of the Radowitz bronze at Constantinople‡ we may more closely define the conception. Hermes Nomios, the protector of flocks and herds, is a divinity of whom little is known from literary sources, his importance being greater in a primitive state of society where wealth is reckoned in cattle, or in pastoral districts where the type, even in later times, would not easily find plastic expression. So far as I know, the creation of such a Hermes has not been connected either by ancient or by modern authorities with the name of any fourth century artist, but a suitable type exists in the two variations, the one repre-

* Furtwängler: *Ath. Mitth.*, iii., 1878, Pl. 13, p. 287.

† Legrand, *Bull. Corr. Hell.*, 1892, Pl. II. and XVII. p. 165; Reg. No. 243.

‡ Conze in *Jahrbuch*, 1887, Pl. IX., p. 133.

sented in the Troezen statue, the other in the Radowitz bronze. In the statue, Hermes holds by the horn a ram seated on its haunches, in the bronze he holds only the severed horn and ear. Even if the copyist has not ingeniously made a support for the statue by substituting the whole figure of the ram for the part of it, we cannot restore our bronze in that way, as there is no trace of any support by the right leg. On the other hand, the upper part of the right arm hangs just as in the Radowitz bronze, and the absence of tension in the muscles proves that the object held was light.

It may be argued that the duty of Hermes Nomios was to protect, not to slay, the animals under his charge. Unfortunately, neither the general tradition of the fourth century nor the local tradition of a Hermes Polygios at Troezen throw any light on the problem, but our type differs from that of the sacrificing Hermes as shown on coins, and cannot be a variation of it.

The Hermes illustrates a Greek combination of earlier Greek types—the Mercury* (Plate X., fig. 3) shows a farrago of Greek ideas made for the Roman market.

A self-conscious and theatrical element pervades the attitude. The face is not merely round, but childish, and every line of the body has been exaggerated and thickened. To the attributes of the ephebe type of Hermes the herald (caduceus, winged petasos and chlamys) are added the plume of the Muses, with whom Hermes the orator was closely connected by Hellenistic tradition, and the full purse of the Roman Mercury, the giver of material prosperity, and identified with Hermes Empolaios; wings have been added to the caduceus, and the chlamys is merely a piece of decorative drapery, the whole forming an excellent example of the bad taste which separates Roman from Greek work.

Nothing is more striking in the study of such minor monuments as bronze and terra-cotta figures of Greek workmanship, than the breadth of treatment and artistic good taste which they show. Both these qualities arise from the high level of excellence in *design* required of the craftsman, who was thus forced to use the designs of the great sculptors. The mechanical methods employed for reduction and

* From Thrace; black patina; height 0.14 m. Several similar statues in the Museum at Sofia. See example published by M. Salomon Reinach in *Rev. Arch.*, vol. xxxi., p. 230.

reproduction entail fixity of design when once the mould is made, and it is on this fixity that I wish to lay stress in claiming for bronze statuettes, even the roughest, a more important place than they have hitherto held.

In conclusion, I desire to express my warm thanks to M. Staïs for permission to publish the *Misthos* bronze in the Central Museum, and to M. Perdrizet, of the French school at Athens, for his kindness in making over to me the photographs of the other two statuettes.

C. A. HUTTON.

ARCHAISTIC RELIEFS.*

(PLATES XI.—XIII.)

On a bien voulu faire à ces quelques notes l'honneur de les insérer dans l'Annuaire de l'École anglaise. Je ne voudrais pas que l'on mesurât à la faiblesse de mes συμβολαί la gratitude que je dois et que je garde à l'hospitalière maison de Kolonaki. Puissent mes jeunes camarades de l'École française trouver à l'École anglaise des amitiés pareilles à celles que j'y ai faites ! Je ne puis former pour eux de meilleur vœu.

I SAW the four reliefs which form the subject of the present study in Turkey; three are in the Museum at Constantinople, and one at Aïdin (Tralles), at which latter place two of them are known to have been found. I publish them together in the hope that they may add some fresh information on the difficult question of Archaistic Reliefs.

About ten years ago M. Hauser discussed this subject, the result of his enquiries being that it was a mistake to relegate *all* Archaistic Reliefs to the time of Augustus and of Hadrian, and that this mannerism originated at a much earlier date. This theory is confirmed by two recently published monuments, firstly, the relief found at Delos† in a house belonging to the second century B.C., and secondly, the fine base from Epidaurus,‡ which shows a figure of the purest archaistic style side by side with others of a kind which might well have been sculptured about 300 B.C. How far back may we place the origin of this archaistic art? Perhaps as far as Callimachos,§ who was famed for

* The translation of this article has been most kindly undertaken by Miss Hutton, to whom the writer and editor owe their best thanks.

† *B. C. H.*, xix., p. 478.

‡ Defrasse and Lechat, *Epidaure*, p. 87. 'Εφ. 'Αρχ., 1895, Pl. 8.

§ Furtwängler, *Masterpieces*, p. 438.

his *λεπτότης* and for his *χάρις*, and whose *saltantes Lacaena* seem to have provided archaistic sculptors with one of their favourite designs. Further back than this it does not seem possible to go, nor to accept the suggestion of M. Salomon Reinach * that there is no break between archaic and archaistic art, that one ends and the other begins with Calamis, and that some monuments which are generally classed as archaistic (as for instance, the puteal of Corinth or the relief of Panticapaeum), should really be considered as the final efforts of Archaism.†

There is no doubt that the archaistic style is a hieratic style, especially used for altars, puteals, palladia, bases of candelabra, and, in a general way, for monuments erected in sanctuaries; subjects relating to Apollo, whether the Delian or the Delphic god, are frequent. Now it is a curious thing that neither in the Temenos of the Delian Apollo, nor at Delphi, have any archaistic remains been found. The probable explanation is that the Romans were particularly fond of monuments executed in this style, and that the marble candelabra in the sanctuary of Pythô were carried away by Sylla and Nero. Probably, however, the greater number of Archaistic Reliefs issued from Italian studios, and hence the interest of the four here described, all of which are undoubtedly Anatolian in origin.

I.

The fragment here reproduced (Plate XI.) is the left-hand upper corner of a white marble relief which in 1895 was in the possession of Dr. Apostolidis, Consular Agent for France at Aidin (Tralles), where I took an impression of it.‡ On the left is a bearded Dionysos facing to the right, holding the handle of a large cantharos in his right hand, and probably also supporting its foot with his left. On the right is a figure facing Dionysos, Ariadne or a Mænad (?), but of this personage nothing remains except the right hand holding a thyrsos, from the vertical position of which we may gather that the

* *Monuments et mémoires de la fondation Piot*, ii., p. 56.

† *B. C. H.*, xx., p. 451 (Pottier). *Revue des Études Grecques*, 1896, p. 278 (Lechat).

‡ Height 0·155 m., length 0·255 m., thickness 0·03 m. The drawing was made by Mr. F. Anderson from this impression.

wielder of it was not dancing, but standing motionless like Dionysos. The tablet which, when perfect, would be almost square (0.33 m. by 0.33 m.), contained only these two figures framed by a border in relief, and may have served as an ex-voto, or, on the other hand, it may have been merely a decorative panel.

The design is executed in such low relief that an impression of it could be taken with quite thin paper, and the outline of the figures is not incised, as in some of the loutrophoros reliefs; we may also note the excessive attention to detail shown in the rendering of the hair, which is as fine as if the artist were working in metal, and the studied elegance of the hand holding the vase, which is sufficient in itself to stamp the work as archaistic.

II.

The fine fragment depicted in Plate XII, *a*, also comes from Tralles (Aidin), where the late Baltazzi Bey, who secured it for the Museum at Tchimli-Kiosk, assured me that he had found it embedded in the wall of a djami,* and hence the beautiful white marble of which it is composed has weathered to a wonderful golden tone. The figure, which when complete must have been about 0.45 m. high, is probably a Dionysos. We can have no hesitation in describing the style as archaistic, for the mantle with its long pointed train, the undue slenderness of the proportions, the mincing walk on the tips of the toes, sufficiently proclaim the school to which it belongs. Though the treatment in this case is neither hard nor dry, the feet are so finely formed, the long slender hand resting on the bending thyrsos so graceful, the folds of the drapery are arranged and worked out with such a feeling for light and shade, that we can but regret the destruction of the rest of this decorative panel, which would certainly have been one of the finest and most charming extant specimens of archaistic art.

* Joubin, *Catalogue des Sculptures du Musée Impérial Ottoman* (Constantinople, 1893): "Male figure walking to the left, resting on a staff, dressed in a long floating Ionian chiton, the folds of which fall gracefully. Fine Hellenistic work." The reproduction on Plate XII, *a*, has been made from a very good photograph, taken at my request by the orders of H. E. Hamdy Bey. Dimensions: height, 0.31 m.; thickness, 0.04 m.

III.

The two large reliefs reproduced on Plate XIII. are now at Tchinli-Kiosk, and have apparently been for a long time in Constantinople, though Albert Dumont makes no mention of them in his article on the collection at St. Irene.* Where they came from is not known, for the tradition (mentioned by M. Joubin in his catalogue) which refers them to Salonica, does not rest, as the late Baltazzi Bey informed me, on reliable grounds. Both these reliefs are of white marble, which has been reddened in places by the action of fire,† and though it is not so stated in the catalogue of the Imperial Museum, we are tempted to believe that they come from the same monument, for they are of the same height and breadth, the figures are of the same size, so are the plinths, the degree of relief is the same in both, and in marble and style they are identical. What the monument was to which they belonged, it is difficult to say; I should be inclined to suggest that they are the short sides of a sarcophagus; for, owing to the absence of inscriptions, they cannot have been votive tablets.

RELIEF *a.*

The first relief has been thus described by two archæologists who evidently did not devote much time to it.

Reinach, *Cat. du Musée Impérial* (1882), No. 242: "Youth crowned by a victory holding a trophy; to the right a groom holding a horse." Joubin (*do.*), No. 122: "Ex-voto to the Dioscuri. In the middle a standing figure with long hair (presumably female), dressed in a short chiton belted round the waist and fastened on the shoulders. One hand possibly holds a weapon. To the left, one of the Dioscuri wearing a cuirass—a chlamys thrown over his shoulders—stands holding a horse by the bridle."

It is strange that it did not occur to either writer that the central figure is *Artemis*, for with her left hand she holds a bow, the string of

* *Rev. Arch.*, 1868, ii., p. 237; *Mélanges*, p. 256.

† The photographs here reproduced were made by order of the Museum authorities. The result would have been more satisfactory had the moss encrusting the reliefs been cleaned off. The white blotches are caused by it.

which, it is interesting to note, is given in relief, and with her right she is feeling for an arrow in the quiver, the top of which appears behind her neck. It is more difficult to give a name to the figure on the right. He wears a cuirass, therefore he is not one of the Dioscuri; moreover, on reliefs we hardly ever find one of the Dioscuri alone, and besides they are both figured on the other tablet. We have here to do with a god, because he is the same height as Artemis and Niké, and the temptation is strong to call him Ares. The Niké type facing to the right, with a trophy in the left hand and a crown held out in the uplifted right, is shown on a gem* (due allowance being made for the reversal of the design in printing). The gold coins of Pyrrhus† also show her moving to the right with trophy and crown, but the hand which holds the latter is lowered, not raised.

It is obvious that in this relief, as in the one from Epidaurus, we have an archaistic figure, the Niké, side by side with figures which have no such tendency. This archaistic mannerism is shown, not only in such details of costume as the long pointed train (*en queue d'hirondelle*) and the arrangement of the hair, the crobylos being a rather clumsy imitation of the archaic crobylos, but also in the details of execution, such as the affected and over-minute rendering of the hair, the wings, and the drapery.

IV.

Ὅταν δὲ κάμψῃς καὶ τελευτήσῃς βίον,
θεὸς κέκλήσῃ, καὶ Διοσκύρων μετὰ
σπονδῶν μεθέξεις· ξενία τ' ἀνθρώπων πάρα
ἔξεις μεθ' ἡμῶν· Ζεὺς γὰρ ἔδε βούλεται.

Eur. *Helena*, v. 1666—1669.

The corresponding relief has no traces of the archaistic manner, but the two evidently cannot be separated from one another.

RELIEF *b*.

Reinach (*op. cit.*), No. 240: "Woman standing between two men; on either side the protomè of a horse. Ex-voto to the Dioscuri."

* Gori, *Mus. Flor.*, ii., Pl. 71. Reinach, *Pierres gravées*, Pl. 65.

† *Cat. of Greek Coins, Thessaly, &c.*, Pl. XX.

Joubin, No. 121: Ex-voto to the Dioscuri; in the middle stands Helen, clothed in a long tunic, her head veiled by one corner of her mantle. Roman work.

The standing, full-face figure of Helen between her brothers, represented either as riding towards her or holding their horses by the bridle, appears on a certain number of monuments of very varied origin. I propose to enumerate them, and then to try to explain the religious meaning of the type.

1. *Sparta*.—The starting point of the inquiry is necessarily Sparta, for the type originated there in the home of the Tyndaridae. From a very early period Helen was worshipped* on Mount Menelaion (possibly the site of the Homeric Sparta), and the Dioscuri had a temple there.† On the other hand, it was Kastor and Polydeukes who brought the girl Helen back to Sparta from Aphidna or Athens, whither Theseus had carried her off. Further, at Sparta have been found the records of a society which, in the first century B.C., worshipped the Dioscuri and Helen by sacrifice and banquet (*σπιήσεις*); these records are the lists of the members of the society; they do not contain the actual names of the Tyndaridae, but the reliefs engraved at the head of the lists leave no doubt as to the individuality of the divinities worshipped by the *σπιηθέντες*, for they represent Helen between her brothers.‡ Further, it has been noticed that among the officials of this society figures a *γυναικονόμος*, who, like the same official at Andania, chose by lot the *ιεραί* and the *κοραί* who were to take part in the *πόμπη*, and saw that their costume was that prescribed by custom, &c. Hence it follows that women as well as men took part in the festivals of Helen and the Dioscuri—a natural enough custom, because it was in honour of the heroine as well as of the two heroes. Now we learn from Hesychius (*s. v. κάνναθρα*) that the Spartan maidens drove in procession, in a special kind of chariot, to the temple of Helen, doubtless to the one at Therapnè, which, Herodotus tells us, already existed in the sixth century.

* *Herod.*, vi. 61; *Laudatio Helenae*, 63. Cf. Curtius, *Peloponnesos*, ii., p. 316; Wide, *Lakonische Culte*, p. 340; *Rev. Arch.*, 1897, i., p. 9.

† *Stephan. Byz.*, s. v. *Θεράπνη*.

‡ *Annali*, 1861, pp. 38—40, Tav. d'Agg. D.; *Ath. Mitth.*, ii., pp. 201-3. I conclude it is owing to an oversight that Engelmann (*Roscher's Lexicon*, i., p. 1972) states that one of these reliefs was found at Gythion. Only one list of members is complete. The present description is based on M. Foucart's masterly study (*Inscrip. du Péloponnèse*, No. 163A).

This temple had a cultus-statue to which the Helen on one of the lists of the *σιτηθέντες* is certainly referable; she is depicted standing on a pedestal with *ταυρία* or *στέμματα* in her hands, like those held by the Artemis of Ephesus or shown on the Delphic omphalos, on tripods, altars, &c.* On her head she wears a polos, which recalls the headdress of the small leaden figures found in such quantities in this same temple at Therapnè, which either represent Helen herself or female worshippers engaged in celebrating her festival.†

2. *Tarentum*.—It is well known that the worship of the Dioscuri flourished at the great Lacedaemonian colony of Tarentum, but neither here nor in any of the Dorian cities of Magna Graecia, where the coin-types prove the existence of a deeply-rooted devotion to these heroes, does, so far as I know, the schema of the three Tyndaridae exist.

3. *Tyndaris*.—The worship of the Dioscuri flourished also in Messenia, and a Messenian colony in Sicily bore the name of Tyndaris. The coins of this city have for a reverse type one of the Dioscuri on horseback, or the two stars which were the emblems of the swan's sons; on the obverse, a female head with the inscription ΤΥΝΔΑΡΙΣ, representing the *ἡρώσσα* who gave her name to the colony, but Helen between her brothers does not appear as a coin type.‡

4. *Asia Minor*.—We must now travel far from Sparta to find a large series of monuments representing this type, namely to Pisidia and Milyas, where their presence has been accounted for by assuming the existence of local myths, analogous to the Spartan tales of the Tyndaridae, and that the Helen of Pisidian coins and reliefs is a local heroine;§ this is, however, a gratuitously unnecessary supposition, as the existence in Pisidia of monuments which bear the same design as the lists of the Spartan *σιτηθέντες* is more easily explained in the light of the following facts:—

* Furtwaengler, *Masterpieces*, p. 408. For the Artemis of Ephesus, cf. *Cat. of Gr. Coins, Ionia*, Pl. 13. For the altar, cf. Schreiber, *Reliefbilder*, Pl. LXVI. For the lyre of Apollo, cf. Schreiber, Pl. XXXIV.

† I published these figures in the *Rev. Arch.* (1897, p. 9, Pl. I., II.), and endeavoured to show the pre-Dorian origin of the religion the existence of which they prove. Two collections exist—one in the National Museum at Athens and one in Munich.

‡ *Zeitsch. für Num.*, iii. 27, Pl. I. (von Duhn).

§ Hill, *Catal. of Gr. Coins, Lycia*, p. lvii. M. Radet does not touch on these Lacedaemonian settlements in his remarkable essay (*Rev. Arch.*, 1893, i., p. 185).

Selgé, one of the most important cities in Pisidia, owed its second foundation to Lacedaemonian colonists. The testimony of Strabo (xii. 570) is confirmed by the evidence of coins, for we have one struck on the occasion of an alliance between Selgé and Lacedaemonia (Mionnet, iii. p. 525, No. 192).

Sagalassos, to the north of Selgé, is probably a colony from that town, for its name is formed by adding the termination *assos*, so frequent in names of Pisidian cities, to the word Selgé. The hero **ΛΑΚΕΔΑΙΜΩΝ** is represented on the coins of Sagalassos, as well as the Dioscuri and their twin altars.

Amblada, another Pisidian city, boasted also of its Lacedaemonian origin, as is shown by the inscription on its coins, **ΑΜΒΛΑΔΕΩΝ ΛΑΚΕΔΑΙΜΟΝΙΩΝ**. So far, we have no coin from these three towns, Selgé, Sagalassos and Amblada, representing Helen between the Dioscuri, but there is no doubt that it was from here that the worship of the Tyndaridae spread through Western Pisidia, where its existence is attested by the reliefs of *Alifaradin* and *Fazir* * in Milyas, and by the coins of *Termessos Major* † and *Codroura*, ‡ all of which monuments, whether coins or reliefs, date from Imperial times.

From Western Pisidia the type passed into Lycia, as is proved by a coin of *Acalissos*, § and a relief from *Telmessos* which M. Bérard describes as follows: "Bas-relief of poor workmanship representing two horsemen facing one another and a draped female statue, doubtless the Dioscuri and the Artemis of Telmessos." || While it is true that the inhabitants of this city worshipped Artemis, it is certain that the draped figure standing between the Dioscuri can be no other than their sister Helen.

5. *Attica*.—Reference has already been made to the story which connects the three Tyndaridae with Attica; but no Attic bas-relief representing Helen between her brothers has been found in Attica, save the sarcophagus at Kephisia. ¶ Perhaps this sarcophagus, which is not of particularly late workmanship, was made for a member of the great Kephisia family to which Mikion and Eurykleides belonged, the two brothers who were for some time at the head of affairs in

* *Reisen in Lykien*, ii., pp. 168—171.

† *Cat. of Gr. Coins, Lycia*, p. 270.

§ *Op. cit.*, p. 40, Pl. IX. 12.

¶ *Urlichs, Beiträge zur Kunstgeschichte*, Pl. XVI. = Roscher, i., 1591.

‡ *Op. cit.*, p. 211, Pl. XXXIX. 9.

|| *B. C. H.*, xiv., p. 176.

Athens and were poisoned by order of Philip V. of Macedonia. Tetradrachms which bear the names of Mikion and Eurykleides* have the Dioscuri as a magistrates' symbol; we know that they were worshipped in Attica, as the *μεγάλοι θεοί* in the deme of Kephale at the entrance to Laurion (Paus. I, 13, 1), as the *ἄνακες* at Athens (*ibid.* I, 18, 1). The priest of the *ἄνακες* had a special seat in the theatre of Dionysos (*C. I. A.* iii. 290) and their worship, which was of long standing (*τὸ δὲ ἱερὸν τῶν Διοσκούρων ἔστιν ἀρχαῖον*), is mentioned in inscriptions as early as the 5th century (*e.g.*, *C. I. A.* i. 34). It is quite possible that the great Kephisia family to which Mikion and Eurykleides belonged discharged the duties of priests of the *ἄνακες* at Athens; possibly, too, they boasted of having offered hospitality to the two heroes, or again, like the great Spartan family of Eurykles,† they may have claimed descent from them. The coincidence of the two names Eurykles and Eurykleides is at any rate curious.

Finally, in ending this account of the Athenian worship of the Dioscuri, it may be mentioned that, judging from Pausanias' account of the group in the *Ἀνακείων*, neither the type of Helen between her brothers, nor that of the Dioscuri by themselves on horseback, existed at Athens (*αὐτοὶ τε ἐστῶτες καὶ οἱ παῖδες καθήμενοι σφισὶν ἐφ' ἵππων*).

6. *Macedonia*.—At Stobi, in Macedonia, M. Heuzey found a bas-relief without any inscription, representing the Dioscuri and Helen.‡

7. *Epirus*.—Ampelius, in enumerating the *mirabilia mundi*, mentions a mural picture of Castor, Pollux, and Helen at Ambracia in Epirus. "*Ambraciæ in Epiro in pariete sunt picti Castor et Pollux et Helena, manus autochthonis, et nemo invenire potest quis pinxerit.*"

8. *Origin unknown*.

A votive relief of unknown origin in the Museum at Constantinople shows a group of Helen between her brothers § and bears the following inscription, ΑΓΑΘΩΝ · ΔΙΟΝΥΣΟΥ · ΔΙΟΣΚΟΡΟΙΣ || · ΚΑΤΕΥΧΗΝ

9. In the Lewis Collection is a carnelian which represents a female figure (Helen) standing between the equestrian figures of Castor and

* Head, *Attica*, p. 66, Pl. XI. 7; cf. Théodore Reinach, *Revue des Etudes Grecques*, i., p. 172.

† Weil, *Die Familie des C. Julius Eurycles* (*Ath. Mitth.*, vi., p. 10); *B. C. H.*, xxi., p. 209.

‡ *Rev. Arch.*, 1873, ii. p. 40, reproduced in the *Mission de Macédoine*.

§ Joubin, No. 123.

|| *Sic.* Joubin Διοσκούροις.

Pollux. Helen holds a sceptre in her hand and has the crescent above her head, as in the coin of Termessos Major.*

10. In the British Museum is a gold ring from the Hamilton collection, which has the Dioscuri on foot leaning on their lances, and between them Helen veiled, the lunar crescent on her head.

Monuments not referable to the motive.

11. It has been stated more than once that the type of Helen between the Dioscuri occurs as early as the chest of Cypselos. But Pausanias says: *Εἰσὶ δὲ ἐπὶ τῇ λάρνακι Διόσκουροι, ὁ ἕτερος οὐκ ἔχων πω γένεια, μέση δὲ αὐτῶν Ἑλένη. Αἶθρα δὲ ἢ Πιπθέως ὑπὸ τῆς Ἑλένης τοῖς ποσὶν ἐς ἔδαφος καταβεβλημένη.*† Thus a scene was described representing four people, Helen and Æthra between Castor and Polydeuces. This scene, the central group of which must have been in violent motion, was quite different from the hieratic *ἐπιφανεία* of the Tyndaridae on the monuments before enumerated.

It is curious that one of the twins on the chest was represented beardless, the other bearded, though this curious variation does occur on one extant monument, a sarcophagus at Arles,‡ on which, however, as the work belongs to a late period (possibly the 3rd century, A.D.), it is probably connected with the sepulchral nature of the monument, and with the symbolical ideas with which the designers of Roman sarcophagi were deeply imbued.§

12. No mention so far has been made of the numerous Etruscan mirrors, which are decorated with this design of Helen between her

* Described by Middleton as "a standing figure of the Oriental Artemis or Moon Goddess between Castor and Pollux." *The Lewis Collection at Corpus Christi Coll., Cambridge*, p. 68, No. 97.

† V., 19, 2. Cp. Dio Chrysostom, xi., p. 325 R. For the discussion cp. H. Stuart Jones, *Journal of Hellenic Studies*, 1894, p. 76.

‡ *Gaz. Arch.*, 1878, Pl. I.; Le Blant, *Sarcophages Chrétiens d'Arles*, p. 38.

§ Maurice Albert, *Le culte de Castor et Pollux en Italie*, describes a Roman lamp with only one figure and that one bearded, but it is impossible to discuss it without a personal examination, and I am tempted to believe that the figure is not one of the Dioscuri. The author further (*op. cit.*, Pl. III.) reproduces a lamp which exists in the Cabinet de France, which, as he states, bears *bearded* heads of Dioscuri (similar lamp in d'Agincourt, *Sculpture antique en terre cuite*, Pl. XXIV. 5); but these Dioscuri are really the Cabiri of Samothrace, who were assimilated to the Dioscuri. In proof of this assimilation, compare a lamp in the British Museum (Sloane Collection), which represents Dioscuri heads *beardless*, but surmounted in the same way by the four-pointed star. The vases quoted by Mr. Frazer (Paus., iii., 616) have no bearing on the question of the Dioscuri.

brothers,* and the reason for this omission is that the treatment of the subject on the mirrors is so entirely different from that on the monuments previously described, that we must carefully avoid confusing two types which differ so widely. On Etruscan mirrors Helen is nude or semi-nude; her brothers, without their horses, stand beside her in heroic nudity; and their meeting, at which others are often present, is treated in a spirit of gallantry quite in accordance with the object decorated. The Spartan reliefs and their derivatives show us a widely different scene. Helen is there fully draped like a sober matron, and her brothers join her, but not, as once at Aphidna, to take her back to the paternal roof. On the *σιτηθέντες* reliefs and on the one from Alifaradin she wears a polos; on the two from Constantinople (Relief *b*, Plate XIII., and No. 9 of our list) her head is veiled in her mantle; the Stobi relief gives her an aureole, and one of those from Sparta places her on a pedestal: hence it would seem as if the locality implied, so to say, in these reliefs, were the interior of the temple of Therapnè; we have the statue of Helen, and hither her brothers come or are coming, *ἐπιφανέστατοι θεοί*, to take part in *ξένια* in their sister's temple.

The Kephisia sarcophagus, on which the Dioscuri have no horses, offers no valid argument against this explanation, and from another point of view has an important bearing on it, for it proves the sepulchral appositeness of our type. It is well known that the two Dioscuri without their sister often appear on Roman sarcophagi; the two heroes, who had been cut off in the flower of their youth, appropriately symbolized sudden and premature death; on the other hand they were *the* heroes *par excellence*, patron saints, as it were, of the dead, who, like them, became *ἥρωες*; finally, being *θεοὶ σωτήρες*, saviours of men, they were helpful, not only to the sailor, but to the dead, and what Castor and Pollux did for *ἥρωες* Helen would naturally do for *ἥρώισσαι*. Helen, who had helped Hades to garner so rich a harvest, was no mere mortal, she was a daughter of Zeus—*Διὸς κόρη*—; at Sparta she was a goddess. In the same way, Phaedra at Troezen seems to have been the object of a cult. It is certainly she who appears to be referred to in a dedication in the local dialect found at Troezen by M. Legrand, *B. C. H.*, xvii., p. 94. In Italy, as in all Latin lands, the brothers of Helen were

* Gerhard, *Etrusk. Spiegel*, ii., 203; v., 71-81; Albert, *op. cit.*, p. 130.

represented without her on sepulchral monuments, but this was not the case in Greek countries.

It has already been suggested that the two Constantinople reliefs (*a* and *b*) are the short sides of a large sarcophagus. The Macedonian relief from Stobi is probably not a votive tablet, but a sepulchral relief; Helen seems to be carrying a torch, as if she were really an under-world divinity, another Persephoné or Hecaté. With this relief we may connect another Macedonian one, from Cerdylum near Amphipolis,* which is extremely important as proving the funereal character of the schema of Helen between the Dioscuri and its bearing on the study of the worship of the heroes. On a pedestal stands the statue of a woman (Calliopé), a draped full-face figure; this pedestal bears the inscription **XAIPE**, the farewell to the dead; the brothers of Calliope, two of whom have Thracian names, Zelmoutas, Dioscourides, Zeipyrrion, ride up at a hand gallop, two to the left, one to the right. The inscription styles them *ἡρώες*; if they had been only two not three in number, should we not call their tombstone an ex-voto to the Dioscuri? for the same idea which suggested this sepulchral monument is certainly the basis both of the Stobi and the *σιτιθέεντες* reliefs.

To return to these latter, it is very probable that the Spartan society regarded the Tyndaridae especially in the light of funereal divinities and protectors of the dead. The development of the beliefs relating to the heroization of the dead is a somewhat late one, and we saw that the lists of the *σιτιθέεντες* were not anterior to the 1st century B.C.

We may quote the words addressed by Horace to Vergil's ship—

"Sic te diva potens Cypri
Sic fratres Helenæ, lucida sidera," &c.

or by the Dioscuri themselves to their sister Helen in the lines of Euripides:†

[Σωτήρε δ' ἡμεῖς σὼ κασιγνήτω διπλῶ
πόντον παριπτεύοντε πέμψομεν πάτραν.

And we also know that the Pharos was dedicated to the "Saviours" (Θεοῖς σωτηήρσι), *i.e.*, quite as much to the Dioscuri as to Ptolemy Soter

* B. C. H., xviii., p. 436.

† *Helena*, v. 1664, 1665.

and Arsinoë. The Dioscuri were in fact the tutelary heroes, not of the dead only, but also of those "that go down to the sea in ships," and in both characters their sister Helen was associated with them, though, according to popular belief, they brought fine weather to the sailor and she brought storms.* The question therefore arises whether among the monuments which give all three Tyndaridae together there are any where their claim to representation is based on their seafaring character. It is possible that the relief of Agathon and the one found by M. Bérard in the seaport town of Telmessos (Makri) were offered by sailors, but there is absolutely no means of proving it. The greater part of the monuments which depict the three Tyndaridae come from inland towns and have no connection with the sea at all. A votive tablet offered to them because they were seafaring deities would be something new, and as far as our present knowledge goes we may affirm that the schema of the three Tyndaridae is purely heroic and funereal in meaning.

PAUL F. PERDRIZET.

[The sculpture represented in Pl. XII. *b*, is the fragment of an archaistic relief in the possession of M. E. Duval, of Morillon, Geneva, which is described by Von Duhn in *Arch. Anzeiger*, 1895, p. 54, fig. 10. The small text illustration there given led me to believe that this fragment must have formed part of, if it did not actually join on to, the Tralles relief on Pl. XII. *a*. The two fragments are unquestionably in the same style, and have certainly represented parts of the same subject.

M. Duval, with great courtesy, specially photographed his fragment for me, and gave me permission for its republication, furnishing me at the same time with fresh details which make it clear that the two fragments are from separate monuments. Thus the opinion of M. Perdrizet, who had almost from the outset contested the *rapprochement*, was absolutely confirmed; but he kindly agreed that the Duval fragment should appear on his plate, and allows me to add this note. The juxtaposition of the two, reduced to the same scale, is sufficiently suggestive to answer for itself; and I think it will be conceded that my supposition, though mistaken, was not unnatural.

M. Duval's account is as follows:—"This Bacchus, or priest of Bacchus, was procured for me in 1886 by the late M. Walter Fol, who was then at Rome. He never informed me of its provenance, but in a letter which he wrote to me at the time he stated that other less important fragments of the same altar accompanied the one sent me, and specified two heads of rams which in all probability bordered the composition on either side. The marble is Greek, of a very close grain and very hard; it is, however, not Parian. The dimensions are 0.256 m., greatest height; 0.19 m., greatest width. The thickness of the upper part is 0.022 m. for the whole width; the lower part on the right side is 0.015 m. thick, but only 0.005 m. on the left side (not including the reliefs). The two surfaces, although both plane, are not parallel, there being an in-

* Maurice Albert, *op. cit.* pp. 64, 65.

crease of 0.010 m. at the lower right-hand corner. The most salient part of the relief at the break measures (including the thickness of the slab) 0.032 m., and when this is compared with the thickness (0.04 m.) of the Tralles fragment at the same point, it seems scarcely probable that the two fragments can form part of the same relief; the more so, as the width of the Tralles fragment (0.31 m.), which is almost entirely occupied by the figure, would give a measurement altogether out of proportion to that of the upper part of the figure on the other fragment."

Though, therefore, it is fairly clear that the two fragments are from separate monuments, it seems to me equally clear that both, when complete, represented the same type of Dionysos. It is a variation of the type given in Hauser, *Neu-Attische Reliefs*, Pl. I., No. 10. The mention of rams' heads in M. Duval's letter makes it probable that his fragment is part of a three-sided base, such as is described in Hauser under type VII., *a*; on p. 135 he describes one such example (No. 47 of his list) which has rams' heads at the upper corners. This same base (*op. cit.*, p. 36) has a relief of Dionysos which must resemble ours very closely. The popularity it enjoyed among sculptors of archaistic works is referred to by Hauser, who mentions the fact that no less than four examples of it are known to him.

C. S.

A MARBLE RELIEF FROM THE AFRICAN TRIPOLIS.

(PLATE XIV.)

THE sculptured slab represented on Pl. XIV. was found recently somewhere in the hills about Tarhuna, namely, in the eastern section of the line of high ground which lies about a day's journey from the sea behind the coast desert between Oea (Tripoli) and Leptis Magna (Khoms or Lebda). It was seen in private possession at Khoms in 1896 by Mr. H. Swainson Cowper, has since been acquired by him, and is now in his house, Yew Field Castle, Outgate, Ambleside. He has figured and briefly described it already in his recent account of his journeys in the province of Tripoli;* but has kindly permitted the reproduction of it here, from a fresh photograph, and with a rather fuller commentary, in the preparation of which a number of valuable references and suggestions have been very kindly placed at the disposal of the writer by M. P. Perdrizet, Member of the French School of Archaeology in Athens.

The slab measures 3 ft. by 2 ft. 4 in., and is practically perfect. The upper and lower margins have an unornamented projecting band, which frames the relief; but the lateral margins, which are both entire, are free, making it probable that the figures represented upon this slab formed part of a larger scheme. There is indeed a small clear space between the extremities of the figures and the lateral edges of the slab, but the first and third figures clearly look away at something beyond its limits.

The group consists of three fully draped female figures, who advance to the left with a dancing step. The second and third grasp tightly

* *The Hill of the Graces*. London (Methuen), 1897, pp. 217, 218, Fig. 62.

with their left hands a fold of the mantle of the preceding figure, drawn tightly back over the left arms. The first figure looks straight before her, and her face is consequently in profile. Her wavy hair is confined closely to her head by a double band. Her right hand is raised almost to her chin, and is wholly enveloped in her mantle, one fold of which is drawn across the lower part of her face, barely leaving the lips exposed. Her left hand escapes from the mantle, and droops with the elbow somewhat bent, and the fingers loosely extended. Her left foot is in advance, and her right is almost wholly concealed by elaborate flowing drapery.

The second figure looks somewhat downwards and to her left: her head is represented in half-front, and her body in half-back view, with the right foot in advance, and the left almost off the ground. A handkerchief is tied over her head and behind her neck, but a loose stream of dishevelled hair escapes from it behind. Her left hand is posed like that of the first figure, whose mantle she grasps with her left, which is exposed.

The third figure looks downwards and backwards over her left shoulder, so that her face is turned almost fully to the front. Her wavy hair emerges, above her forehead, from a hood, perhaps formed of a fold of her mantle, which is seen again behind her neck on both sides. The upper part of her body is turned nearly half-front, with the right foot leading and the right hand enveloped, as in the second figure. A long fold of the mantle thrown over the left arm, and corresponding with that which in the other figures is grasped from behind, floats freely in deep folds below her waist.

Thus the group is a typical and most graceful example of a well-known Attic motive,* and reproduces with great detail the pose of the earliest-known example of it; namely, the small marble *ex-voto* from Eleusis, published by M. Pottier.† In this the three figures dance in a grotto, while Pan plays before them on his pipes, and, as M. Pottier has shown, there can be little doubt that the motive was originally appropriate to the Nymphs, who are expressly named in the later examples of this and closely allied schemes; rather than to the Charites or the Horae, whose claims M. Pottier has rightly dismissed

* Hauser, *Die Neu-attischen Reliefs*, Pl. III., No. 46.

† *B. C. H.* v. (1881), Pl. VII., pp. 349-57. Hauser, p. 140.

as unfounded, at all events for the period of the Eleusis relief. Whether at a later period this particular motive was transferred to other goddesses, is a question which in this instance rather needs further discussion.

Mr. Cowper remarks of the figures on this relief, that "it is possible that they are the three Graces,"* and brings this attribution into connection with the *Χαρίτων λόφος* of the Tripolis, the site of which he has endeavoured to identify. It would be interesting if, on an example from the same neighbourhood, the identity of the figures could be established in this sense; but at present the evidence seems to tend the other way.

It is true that the familiar and early motive appropriate to the Charites, best known from the Chiaramonti relief,† and, in highly archaistic guise, from the Borghese altar,‡ and traced back by Bendorff§ with great probability to the celebrated example by the younger Sokrates, is frequently used to represent the Nymphs in grotto scenes which in other respects resemble the relief from Eleusis: || even the male figure who heads the procession of the Charites,¶ and who originally represents Hermes, being sometimes reproduced, though without distinctive attribute, as in the *ex-voto* of Telephanes.**

But in every detail of pose and gesture the three *Charites* of the Chiaramonti or Sokratic motive differ throughout their career from the *Nymphs* of the motive of the relief from Eleusis; as the following principal examples of the latter will show.

(1.) The Eleusis relief, already cited†† clearly points to a distinct motive already in vogue at the end of the fifth century, and not improbably in existence even before the masterpiece of Sokrates. The absence of Hermes, the presence of Pan, and the indications of the Grotto all go to show, as M. Pottier has observed, that Nymphs are here clearly intended.

(2.) The Tarhuna relief agrees in detail with No. 1, and cannot be separated from it by more than a century, to judge by the great delicacy

* *L. c.*, p. 218 n.

† *Arch. Zeit.*, 1869, Pl. 22.

‡ Müller-Wieseler, *Denkmäler d. a. Kunst*, i. 43.

§ *Arch. Zeit.*, l. c.

|| Furtwängler, *Coll. Sabouroff*, Pl. XXVIII. Millin, *M. G.*, 326, 328.

¶ *e. g.*, on the "Corinthian Puteal." *J. H. S.*, vi. p. 48.

** *Ann. d' Inst.*, 1863, Tav. d' Agg., L. 3 = 'Εθν. Μουσ. 1448, cf. *ibid.* 1447.

†† *B. C. H.* v., Pl. VII. = 'Εθν. Μουσ. 1445.

and freshness of the work, and by its vivid suggestion of the modelling of the presumably contemporary figurines.

(3.) The Albani altar* presents, as Hauser has remarked, even closer analogies of detail than the drawing of Zoega would suggest to Nos. 1 and 2 above. It is true that, as in No. 2, the cave is absent, and the motive of the three figures is here transferred to another context. The motives, however, with which it is associated on the Albani altar† are themselves of very uncertain interpretation, and very unskilfully and loosely correlated. In particular there is nothing either in the composition as a whole or in the minute variations of detail in the motive of the three figures, to justify the assumption that anything but Nymphs is intended.

(4.) The Verona altar‡ shows again the same group, preceded by Pan, a slight variation being introduced by making the first of the three figures seize with her free left-hand a corner of his cloak of skin; emphasising however, even so, the essential distinction between the Eleusinian motive and the Sokratic motive, that in the former the garment is seized of a figure which precedes; in the latter the figures stand in echelon,§ or as in the Telephanes relief|| almost abreast, and extend, not left hand to left, but right to left in direct series.

(5.) The Megalopolis relief¶ gives the same three figures dancing in the reverse direction, to the right; and the pose of all the figures is slightly modified. The first figure has borrowed, from the third of the normal arrangement, the carriage of her head, and her right hand the gesture of the left hand, in Nos. 1, 2, and 4. The second looks up, instead of down; and the third has taken over the intent forward gaze of the first figure of Nos. 1—4, and holds a pomegranate and three ears of corn in her disengaged left hand. But the Pan and Grotto are both represented, and Hermes is absent; and there is no more reason for doubting the attribution to the Nymphs in this instance than in the preceding.

* Zoega, *Bassi-rilievi*, Pl. 96 = Hauser, p. 32, and Pl. III., No. 44-6 = Helbig, *Führer*, ii. p. 4.

† Hauser's No. 44, 45.

‡ Hauser, *l. c.*, p. 21.

§ *e.g.*, the two examples from the *Coll. Sabouroff*, Pl. XXVIII, already quoted; cf. 'Eθv. Μουσ. 1446-7.

|| v. note †† on p. 172.

¶ *Ann. d' Inst.*, 1863, Tav. d'Agg., L. 2 = 'Eθv. Μουσ. 1449.

It results, therefore, that in no clear instance is the Eleusinian motive explicitly ascribed to the Charites, or even probably attributable to them: whereas in later Greek and Graeco-Roman art the Sokratic motive, which is originally appropriate to the Charites, is repeatedly used to represent the Nymphs. And this is exactly what is to be expected; namely, that the motive appropriate to the superior and more specialised of two ranks of deities would impose itself upon the inferior; but that the intrusion of the lower motive into the province of the higher would not readily suggest itself, or be tolerated in practice.

JOHN L. MYRES.

REMARKS ON THREE SECTILE PAVEMENTS IN GREECE.

(PLATE XV.)

A COMPLETE, or nearly complete, pavement of *opus sectile*, that is, a pavement of variously shaped slabs of ornamental marbles laid in a pattern, is one of the rarest remains of classical antiquity. In the whole of Italy not a single complete pavement of that description is believed to exist, with the exception, of course, of the pavement of the Pantheon in Rome, and one or two insignificant examples at Pompeii; so that we have to judge of the extent to which the beauties of pattern, colour, and execution were carried in this class of decoration from remains seldom containing more than a few superficial feet, and consider ourselves fortunate that so much is left. A large and very fine piece has, it is true, been recently uncovered in the Forum of Nerva; but as it is at present unprotected from the weather and, moreover, used (with the permission of the municipality of Rome) as an asylum for stray cats, it will not be long before it is disintegrated by damp and frost.

The reason for this general destruction is to be found in the great value of the material of which the pavements were composed.

No one who has had occasion to examine Italian works on classical archæology and topography, published during the seventeenth and eighteenth centuries, can have failed to note the frequency with which they record the complete spoliation, if not destruction, of buildings practically intact at the time of their discovery. With the exception of statues and busts—and not always of these—every piece of marble discovered seems either to have gone into the kiln, or to have been carried away to be re-cut and re-used for ornamental purposes. The rare

marbles which so profusely adorn the seventeenth and eighteenth century churches, chapels, and altars of Rome are derived from the wall-linings and pavements of ancient temples, palaces and baths.

Thus it has happened that in Italy hardly a morsel of the costly and varied pavements and wall-linings, which added such beauty of rich colour and varied ornament to the structures of ancient Rome, is still in existence; though in one or two places, it may be noted, where the floor-covering itself has disappeared, we can trace the pattern formed by the slabs from the marks of their joints left on the concrete bed on which they were laid.

In Greece, however, the exploitation of ancient materials has not taken place to the same extent, and it is thus that, while such pavements must have been infinitely rarer there than in Italy, there are still comparatively perfect examples left in sites from which, had they been in Italy, they would long since have disappeared. These pavements are:—in the pavement of the Theatre of Dionysos at Athens; the large fragment of Roman pavement at the entrance to the Temple of Zeus at Olympia; and the pavement of the Odeum of Herodes Atticus at Athens.

As these pavements do not seem to have attracted much attention owing, no doubt, to the superior attraction—from the point of view of purely Greek archæology—of the buildings in which they are placed, I venture to think that the publication here of a measured drawing of that of the Theatre of Dionysos (Plate XV.), together with a few remarks upon the subject of sectile pavements in general, may be of interest. And I particularly wish to say that as, in measuring, I made a note of what slabs were missing or badly damaged, I hope this drawing may be of interest as a record of the state of preservation of this pavement early in the year 1897.*

I.—PAVEMENT OF THEATRE OF DIONYSOS.

This pavement of the Theatre of Dionysos is probably, with the exception of that of the Pantheon (and also, it must be added, that of

* Dörpfeld, *Gr. Theater*, p. 91, refers to a coloured drawing by A. Winkler of this pavement published by Chr. Kirchhoff in a *Programm* of the Altona Christianeum for 1885. This publication is not in the library of the British Museum, and is practically inaccessible to English readers.

the Odeum of Herodes Atticus, which is merely a plain chequered pavement), the best specimen of a sectile pavement which has come down to us.

Some of the slabs and smaller pieces are missing, however, and where the largest gaps have been left, the empty places have at one time or another been filled up with tiles and broken pieces of white marble slabs, or merely with tiles alone (see A & B on plan). Besides the fact that a number of slabs have disappeared, I cannot help fancying that at one point, C on plan, a tract of the central portion, which is formed of small lozenges (called by Vitruvius *scutulae*), must, at some time or another, have been taken up and carelessly re-laid, as—though none of the lozenges are actually missing at this point—white lozenges are found where coloured ones should be, and one or two coloured lozenges are out of place. Possibly a gap has been filled up with loose lozenges from other parts of the pavement. There are still a few loose ones lying about.

The coloured marbles, it should be noticed, have been very much bleached by the action of the weather, and this makes it very difficult to distinguish between the different marbles when actually standing on the pavement itself, as one must perforce in measuring it. From the higher seats of the theatre, the pattern shows out distinctly enough; and while I was engaged in measuring, a chance shower of rain brought out the colours quite clearly for a while.

The marbles used are—plain white marble; a bluish-veined marble, Hymettian, so far as I could ascertain; splendidly marked cipollino, green-veined bands on a yellowish ground; a red-veined (on white) marble, which I cannot identify; and four small triangular pieces of affricano, which occur near the corners of the great central lozenge.

The great central lozenge, or rhombus, of the pattern is entirely filled with small lozenges of white, blue-veined, and red-veined marble and cipollino, there being thirty-one lozenges to each side of the great central lozenge; the blue-veined marble and the cipollino seem to be used indifferently in the coloured bands, and must, consequently, I suppose, have been of much the same "value" as regards tone, though they differ in tint. Now, as has already been remarked, they are so bleached that it is a matter of difficulty to distinguish between them. In the

centre, the lozenges are replaced by slabs of white marble, five in number, namely, four triangular pieces and an oblong piece in the middle forming an inner rhombus with sides about 4 feet long. This central oblong slab has a circular sinking in it 20 inches in diameter.

The total number of lozenges forming the great rhombus was originally 936, and they are so laid as to form a kind of fret pattern on a white ground. It is worthy of remark that almost this identical fret is to be found in an *opus signinum* pavement at Pompeii, which has just been published by Mr. J. C. Watt in his *Examples of Greek and Pompeian Decorative Work*, the upper figure of Plate XL.

It will be noticed, on looking at the plan, that the transverse lines of the pavement are not quite parallel with the front wall of the stage, and that on one side (the east), the slabs which run at right angles to the transverse bands become narrower as they approach the stage.

The cipollino, as has already been said, is remarkable for the splendour of its colour and markings; and, indeed, the marbles employed in this pavement, and the richer marbles at Olympia, are extraordinary in this respect. They are remarkable also for their thickness; a very desirable quality in marble or alabaster slabs, as, if the slabs are used thin, the colour of the marble is apt to be affected by that of the ground on which it is laid. It is not easy, of course, to tell what thicknesses were generally used in marble pavements, as those of which any fragments are left generally have their edges made up solid with other materials in order to preserve them if *in situ*, or, in some cases, have been re-laid in the floors of museums; while, where the slabs have been taken away altogether, and there is nothing left but the bed on which they were laid, their thickness can only be ascertained if the slabs happen to have left a mark against a wall or plinth, or unless some step or border remains which shows their former thickness. Of course, where slabs were of great extent, as, for instance, in the Pantheon, where there are discs 10 feet in diameter in the portico, and 7 feet in diameter in the interior, and many oblong slabs 2 feet 9 inches by 4 feet 10 inches, a certain thickness is necessary to make the slabs portable with some degree of safety; but in this pavement a large proportion of the slabs average 3 feet by 2 feet. In the Calidarium of the Baths of Caracalla a few discs of grey granite exist *in situ*, and a

fragment of one of these, which is lying loose, is 3 inches thick. In Hadrian's villa, on the other hand, where there was at one time a vast extent of porticoes, courts, and apartments paved with choice marbles, such remains as are left show us that the slabs, not many of which are more than 2 feet 2 inches square, and many of which are much smaller, can hardly have exceeded $\frac{5}{8}$ inch to $\frac{3}{4}$ inch in thickness. In the Theatre of Dionysos, however, one of the blue-veined slabs (to which I have drawn attention on the plan), which is only 3 feet 2 inches by 2 feet 6 inches, is from 6 inches to 8 inches thick, the under side being left very rough, while those of Hadrian's villa are quite smooth. Other slabs I noticed about 5 inches thick, and a loose lozenge which I measured was of the same thickness.

II.—TEMPLE OF ZEUS AT OLYMPIA.

The pavement here is very incomplete, but still a large piece remains in fairly good condition; it is very remarkable for the costly nature and magnificent quality of the materials and their lavish application. It is, of course, very accurately given in Curtius and Adler's *Olympia*, *Tafelband* i., Pl. 8.; a certain number of slabs have disappeared since their drawing was made. The hexagons (*favi*) are of oriental alabaster, the rare *alabastrò dorato a nuvole*, white and yellow, like cream and honey mixed, beautifully waved, and though only $9\frac{1}{2}$ inches in diameter, are from 3 inches to 5 inches thick. Nearly the whole of the east entrance to the temple, at least within the colonnade and between the columns *in antis*, up to the cella wall, must have been covered with this honeycomb pattern in alabaster, bordered on the side towards the steps by bands formed of splendidly marked pavonazzetto, black marble (of a shaly texture), and rosso antico. These slabs are now very much broken; their average thickness is $2\frac{1}{2}$ inches to 3 inches.

The triangular spaces left between the hexagons where they abut against the black edging were not filled in, it should be remarked, with triangles of similar alabaster, but with pieces of rosso antico; two tiny fragments alone remain to attest this.

As the pavement approaches the columns *in antis* the hexagons are replaced by squares (*abaci*) of alabaster, about $7\frac{1}{4}$ inches square; these

are carried right up to the columns, and cut to fit into the flutes. As the slabs are missing between the point where the hexagons leave off and the squares appear, and as no marks are here left on the bed to show the form of the slabs, it is impossible to ascertain how they were joined, or if a border came between them. It is to be presumed, however that they were divided by a strip of marble of some kind, since between the columns *in antis*, close to that on the north side, the floor seems to have been laid with lozenges (*scutulæ*) of pavonazzo, of which two only now remain *in situ*, though there are marks of the border, $3\frac{1}{2}$ inches wide, which divided these lozenges from the alabaster squares.

A great number of hexagons and one or two half-hexagons of alabaster; of lozenges of pavonazzetto, and some fragments of fine cipollino—the place of which in this pavement I have not been able to ascertain—are lying about loose, chiefly on the south side of the temple near the east end.

It is worthy of note, while speaking of the Roman coloured pavement, that the cella of the temple contains the remains of the original pavement of black marble with its raised border of white marble; probably the only example of a Greek temple paved with any other material than white marble or plain stone. This is the pavement in front of the chryselephantine statue, which Pausanias tells us was kept flooded with oil; the effect of this must have been to give it the appearance of being very highly polished, and to make it reflect the image like a looking-glass.

III.—THE ODEUM OF HERODES ATTICUS AT ATHENS.

This pavement is in a very complete state of preservation, but is not very remarkable either for its materials or its pattern. I saw it at a great disadvantage, as at the time of my visit it was covered with a thin layer of half-dry mud. The pavement consists entirely of 2-foot square diamonds of cipollino and white marble alternated; the slabs are well cut and closely laid. Where I was able to measure them they were $1\frac{3}{4}$ inches to 2 inches thick.

A note may be added here on the advisability of measuring Roman pavements, whether mosaic or sectile, in English feet and inches.

The Roman foot so nearly coincides with the modern English, that the various dimensions of the parts of such pavements will be found to coincide surprisingly with our measure. This greatly facilitates the work of measurement, especially when time is an object, by providing an easy multiple; it also helps the analysis of the various patterns and the detection of any correspondence between their various parts.

AMBROSE M. POYNTER.

PANATHENAIC AMPHORAE.

(PLATE XVI.)

SINCE the article by De Witte in *Annali dell' Inst.* 1877, p. 294, this subject has not received much attention from archæologists, although the material has in the interval sensibly increased. In publishing here three documents of a somewhat new interest to the study of Panathenaic amphorae, I propose merely to offer some suggestions which may be worth consideration when the subject comes to be once more comprehensively worked out.

I.

The mosaic of which an illustration is given in Plate XVI. *a*, was discovered in a house in Delos, excavated in 1894 by M. Louis Couve,* to whose kindness I am indebted for the permission to publish it here. The illustration has been made by Mr. F. Anderson, from a pen-and-ink drawing of M. Couve, supplemented by a small photograph which M. Homolle was good enough to send me. Pending a fuller publication in colour, it seemed desirable that a monument of such importance should appear as soon as possible, even in this provisional form.

Its importance is twofold, inasmuch as on the one hand it represents one of the earliest dateable Greek mosaics yet known; and on the other, it gives us the latest date yet known at which a painted Panathenaic amphora (or a picture of one) can be proved to have existed in antiquity.

* See *Bull. de Corr. Hell.* 1896, p. 460 foll.; a very minute illustration of the mosaic is given in the general plan on Pl. V. *g*, *ibid.*; for M. Couve's description, see p. 502.

The houses, in one of which this mosaic was found, belong to a series of which the date has been determined, first by M. Paris, and afterwards by M. Couve, to fall within the second and first centuries B.C.; or, if we may take the evidence offered by the Athenian tetradrachms found among them by M. Couve* as giving a more precise limit of time, between 186—87 B.C. One thing at any rate is positive, that they belong to a date prior to 86 B.C., the date of the destruction of Delos by Archelaos. The importance of this evidence will be seen later; but first let me give the description of the mosaic supplementary to that of the *Bulletin*, from notes with which M. Couve has kindly furnished me.

The frame of the picture consists of a band of maeander ("grecque") between two lines, the outer of which, measuring 1.90 m. by 1.70 m., is black, the inner is bright red. The maeander is for the most part black on white; but in the centre of each square, at the point of intersection, are smaller squares, which in Plate XVI *a* are shown in black silhouette; these are occupied with varying patterns in red and black, with occasional addition of white, thus:—



FIG. I.

(The hatched lines indicate red colour.)

Within the inner square is the amphora, resting on a base. The base is in red and brown mosaic; the palm is green and black, the ribbon attached to it, red: the wreath placed beside the amphora is polychrome, consisting of black, green, blue, brown, red, and yellow. The vase is rendered in red and black, with the evident intention of imitating a painted Panathenaic amphora; thus the figures on the body are black on a red ground, and on the neck and shoulder are two red panels, the whole of the remainder being left black, in imitation of the black glaze of the original vase. The side chosen for representation is the reverse of the vase, showing a charioteer driving a chariot to r., and indicating that the original vase was given as a prize in the most

* *Loc. cit.*, p. 462.

important of all the gymnastic contests, the chariot race. The height of the amphora, as given by M. Couve, is '60 m. (roughly 2 feet) or slightly less than the height usually attained by the actual examples of Panathenaic amphorae which have come down to us, the average for such vases (without the lid) being between 2 feet and 2 feet 8 inches.

The singular simplicity in design of our mosaic, and the style of the pattern surrounding it, are features which are characteristic of an early date in the history of mosaic. The picture before us, as well as the two others belonging to the same pavement* (the one representing a trident with a ribbon tied in a bow on the handle, black on a white ground, the other a black dolphin twined head downwards around a red anchor, also on white, each set diagonally across a square of 0·72 m.), resemble the framed pictures which formed the chief decoration in the earlier wall paintings; they may perhaps be compared with the mosaic pictures which, according to the treasure lists, figured among the offerings in the Delian temple,† *πίνακες ἐμβλητοῦς γραφὰς ἔχοντες*.

It is probable that the earliest Greek mosaics were constructed in pebbles, such as we have for instance in the pronaos of the temple of Zeus at Olympia. In the German excavations near the Enneakrounos a series of houses were found with floors composed of a kind of pebble mosaic, some of which probably date back at least as far as the fifth century B.C. A similar mosaic (to which M. Bosanquet has kindly called my attention) is preserved in the King's Garden at Athens;‡ it is executed in pebbles an inch long, and represents a kind of honeysuckle pattern. Even if it belongs to a comparatively late date, as the adjoining mosaics seem to indicate, it shows what were regarded as the limitations of this class of mosaic, as compared with the work in fine cut cubes. Such a process as pebble-mosaic admitted only of the simplest

* M. Couve has kindly furnished me with the following notes of other mosaics in the same series of houses at Delos: "*B. C. H.* 1895, p. 501, Salle *h*. La mosaïque est très mutilée. Les motifs qui subsistent sont des ornements en forme de boucle, et des grecques entremêlées, multicolores. J'y ai noté les suivants, qui sont conservés avec un éclat extraordinaire; blanc, noir, rouge, jaune, vert, bleu, violet. Le motif le plus original est celui-ci: cercles divisés en quatre segments, deux rouges et deux noirs, sur fond blanc. *Ibid.* p. 502, Salle J. Le sol de cette petite pièce est dallé d'une mosaïque. Le motif central est encadré dans un cadre de mosaïque noire (1 m. by 1·40 m.); puis un second cadre, intérieur, également noire; dans l'intervalle, mosaïque blanche; puis un bandeau de *postes*, en noir, sur fond blanc. Puis, au centre encadré par un bandeau jaune, un motif géométrique consistant en cubes (noirs, rouges, blancs)."

† Homolle in *Mon. Grecs*, No. 7 (1878), p. 48.

‡ Published by Barnsley in *Archit. Assoc. Sketchbook*, vol. ix.

forms of design, such as geometric or floral devices: Athenæus tells us (xii. p. 522, O.) that Demetrius of Phaleron had mosaic floors *ἐν τοῖς ἀνδράσι* which represented *ἄνθινα πολλά*, and this description would apply to the floral patterns of the Olympia temple; it is true that that mosaic has also a figure-subject in pebbles, but it is scarcely likely that the example would be often followed in pebble mosaics of less importance. With the increased facility afforded by the new system of cut cubes, more ambition would naturally be displayed in the choice of design; it must have been some time before the artists recognised the limitations of their art; and in the meantime elaborate pictorial subjects like the Battle of Issos were not considered as being outside the scope of the mosaic-worker. So that *a priori* we may consider that simplicity of design is generally an indication of early date for mosaics.

The Olympia mosaic cannot be earlier than the first half of the fourth century B.C.*; but on the other hand it is hardly likely that it can be long subsequent to the date when cube-mosaic was introduced into Greece, for a shrine so important and so frequented from all countries would certainly have had the best that could be done at the time. Now the few notices which have come down to us all combine in showing that by the middle of the third century cube-mosaic was in full swing in Greece. At the same time, a device like that at Olympia could hardly have originated where cube-mosaic was absolutely unheard of. Probably the true sequence of events is somewhat as follows:—Pebble mosaic in simple patterns grew up spontaneously in Greece at an early date; the opening up of the East under the Diadochi brought in an improved method, with cut cubes in a greater variety of colours; the middle of the third century marks the culmination of the new art, whereof the records of Sosos of Pergamon and the great ship of Hieron of Syracuse are witnesses; the Olympia mosaic represents the transition from the old to the new style, probably in the early part of the third century; after this doubtless pebble mosaic must have dropped out of use, except as a cheap and handy substitute for the other.

In the earlier cube-mosaics of the less pretentious kind, skill in the rendering of actual subjects must have developed but slowly;

* *Arch. Zeit.*, 1879, p. 153.

probably borders and simple conventional patterns played the most important part for a long period. One of the earliest mosaics from a Greek site is that found in the Sanctuary of the Stranger Divinities at Delos, and published in *B. C. H.*, vi., Pl. XI., Fig. 4. The only design of this mosaic consists of a simple border of wave pattern, and a development of the maeander between lines, containing elements which recur in the Olympia mosaic; and yet this work is considered sufficiently important to carry the name of the mosaicist in the inscription which is worked into it, Ἀνταῖος Διοχρίωνος ἐποίησεν. It is evident, therefore, that the decorative patterns of this class of mosaics deserve a certain amount of consideration. How far this may be taken as more than a general indication of date is another question; such patterns in vase painting often supply a useful chronological test; but it is obvious that vase painting was susceptible of a more rapid and even development than mosaic, which covered so wide an area, and was (in the early stages of its existence in Greece at any rate) so scantily employed.

Under the circumstances, then, we can hardly press the deduction suggested by the fact that our mosaic has identically the same rather unusual pattern of maeander (with the same interpolated square at the points of intersection) as occurs in the Olympia mosaic. The evidence collected by the French excavators does not apparently enable us to establish a *terminus ante quem* for the group of private houses in which the mosaic was found; but it seems unlikely that they can be at any rate earlier than the beginning of the second century B.C. We can only suppose that mosaic in its earlier stages in Greece proper was but little influenced by the advances made by artists in outlying places like Pergamon or Syracuse, and developed but little there during the third and second centuries B.C. We shall probably not be far wrong if we assign the mosaic before us to the early part of the second century B.C. It is thus, at any rate, the earliest example of cube-mosaic which has yet come down to us from a Greek site.

The colours used in the principal designs of the Delos mosaics are black, red, and white, with white or yellow for the ground. It is perhaps worth noting that these are precisely the colours given by the later painted vases. With the choice of coloured marbles which must have been available in Greece, this can hardly be a mere coincidence:

possibly at the outset artists accustomed to vase paintings may have adapted from them the colours, as they did the patterns, for mosaic; both arts having in reality a similar function, the decoration of a tectonically defined space.

The latest of the series of dated Panathenaic amphorae at present known belongs to the year 313 B.C.; and it has usually been supposed that the fabric must have come to an end somewhere about this date. Those seeking for an historical reason to account for this lapse of so cherished a tradition have been accustomed to regard 307 B.C. as the *terminus post quem*, when Demetrius became master of Athens, and when doubtless the old order underwent considerable change. That the end was not far off, we see from the exceeding decadence of style exhibited by the latest specimens.

How, then, if this is so, are we to account for our mosaic? We have seen that the house for which it was made can hardly be assigned to a date earlier than 186 B.C. Are we to imagine that vases fashioned and painted in the traditional scheme were still at this date given as prizes in the Panathenaic games; that this mosaic represents, in fact, as M. Couve remarks (p. 503), "le trophée des victoires agonistiques du maître"?

If this be so, and we are to suppose that the painted amphora of our mosaic was won in the second century B.C., the inference naturally follows that the series of painted Panathenaic amphorae was not broken off, as hitherto supposed, in or near 313 B.C., but continued to be issued annually down to the second century. We are then confronted with the fact that of all the prize vases thus given during nearly one and a half centuries, not one has survived to modern times. Surely a very unlikely coincidence!

It seems to me more reasonable to accept the fact that the amphora of our mosaic could not have figured as a prize in Panathenaic Games for many generations preceding the date of the mosaic; and to suppose that it was won by an ancestor of the owner, and was preserved in his family as a cherished tradition; just as, for example, the alabaster vase inscribed with the name of Xerxes was probably preserved in the family of Hekatomnos at Halicarnassos.* The fact that the prize had

* Newton, *Travels*, ii., p. 100.

been won for a race of chariots—the “blue ribbon” of the stadion, a competition which the greatest in the land regarded as worthy of their ambition—would be an additional reason for hereditary pride in the achievement and for choosing the reverse side of the amphora for representation. The fact, moreover, that Panathenaic painted amphorae belonged to a fashion long gone by, and were no longer procurable, would give an added point to the subject of this mosaic.

But a further question now arises: If no Panathenaic amphorae were painted after the fourth century B.C., how is it that in literature we have references to these vases, and on certain monuments (especially coins of Athens) we have them actually represented at dates long subsequent to the fourth century?

A passage in Athenæus, s. v. *Panathenaiikon* (xi., p. 495, a), seems to throw light on this question; Poseidonios, he says, in the 36th book of his history, mentions certain vases as termed Panathenaic; and there were also skyphi* of onyx, and *συνθέσεις* (*συνδέσεις*) *τούτων, μέχρι δικοτύλων· καὶ Παραθηναικὰ μέγιστα, τὰ μὲν δίχρα, τὰ δὲ καὶ μείζονα.*

It is generally accepted that Poseidonios flourished about 100 B.C.; at this date, therefore, it is clear that the name Panathenaic was still applied to a certain class of vases. A quotation from Krates (circa 210 B.C.), given *ibid.*, makes it probable that the name was in his time characteristic of a certain form, rather than as referring to any decoration painted upon it. “The pelikè,” he says, “was a name formerly given to a form of vase” resembling the Panathenaic, but afterwards it had the appearance of an oinochoè, like those set out at the (Panathenaic) festival. That the Panathenaic form of vase existed even so late as Imperial times, we see from the Athenian coins of that period. But it is probable that had they still continued to bear the characteristic paintings, one or other of the authors quoted would have made some reference to the fact. It seems likely that towards the end of the fourth century B.C. the vase had lost its decoration, but still retained its form and name.

It is possible that when once the old tradition of a painted

* On the authority of this passage it has been assumed that there were in antiquity Panathenaic skyphi, and the same has been identified with a class of skyphi bearing the device of an owl within a laurel wreath (Birch, *Anc. Pottery*, 2, p. 379). It is evident, however, that the passage gives no authority for this assumption.

terracotta vase as the prize had been abandoned, its place may have been taken by a vase of metal. In the pompè of Ptolemy Philopator (222-204 B.C.) there figured, we are told,* sixteen Panathenaic amphorae of silver. De Witte (*Ann. dell' Inst.* 1877, p. 305) considers that these were imitations in metal of the true terracotta prize vases; but surely this is improbable: either these vases represented prizes which had been won at Athens, in which case they would not be imitations at all; or, they were intended to be presently competed for, like the Delphic tripods mentioned earlier (v. p. 198, c) as ἀθλα τοῖς τῶν ἀθλητῶν χορηγοῖς; or, they merely formed items in the general display of magnificent plate, together with the 26 hydriae and 160 psykters mentioned with them; in both these last alternatives the name Panathenaic clearly has no reference to the Games at Athens, but merely indicates a particular shape of amphora.

The mention of the word *amphoreis* in the above passage strengthens the probability (which on other grounds† can be shown to exist) that at this date, at any rate, other forms of vases besides the amphora were given as prizes in the Panathenaic games. Probably when once the traditional rule of decoration and material was broken through, other shapes may have been introduced, though the amphora still continued to be the most usual form of prize vase.

The few representations of Panathenaic amphorae that have come down to us from later times certainly suggest that these vases were then of metal. The amphorae which are found on the later coinage of Attica‡ have a strongly metallic character; and in the relief on the marble seat found at Athens (Stuart and Revett, *Antiq. of Athens*, iii., pp. 20, 29) and which is probably the official chair of an agonothetes of the Panathenaia, this is still more marked; on the side of the chair is sculptured a table,§ on which are wreaths and an amphora; beside it is an olive-tree, and below the table a palm. The amphora in this case has a ring in relief around the neck and base, as well as a lid and handles of a form which certainly are most unsuitable to terracotta, and could hardly be rendered except in metal.

* Athenaeus, v. p. 199, d.

† Cf. e.g., the Krates passage quoted on p. 188 above.

‡ That these are prize vases, and not merely, as has been suggested, emblematic of the oil trade, is probable from the fact that on one specimen (*Num. Zeitschr.*, 1871, p. 34, No. 99) Nike crowns the amphora.

§ Cf. B. M. Cat. Coins, *Attica*, Pl. XVII., 5, 7.

The Delos mosaic represents a single amphora ; but if the ordinary theory be accepted, this must be taken as representing a large number of such amphorae which in reality constituted the prize. This theory is based on the fact that in the Panathenaic prize-lists which have come down to us the prizes are estimated at so many amphorae of oil. The amphorae here referred to must clearly all have been of one standard capacity ; but a difficulty at once arises from the fact that the prize amphorae in our museums (like those mentioned in the Poseidonios passage already quoted from Athenaeus) are of varying sizes and capacities. Various ingenious attempts* have been made to explain away this difficulty, but none, so far as I am aware, is completely satisfactory, except the simple explanation of De Witte (*loc. cit.* p. 298) ; after remarking that in the prize-lists the victors receive from 6 to 140 amphorae of oil, he remarks :—“ On doit entendre sans doute par là que les vainqueurs recevaient de 6-140 mesures d’huile : mais le prix honorifique ne devait consister qu’en une couronne et une seule amphore de terre peinte.”

That is certainly the most natural and obvious explanation. The amphoreus of the prize-lists is a measure of capacity : in that singular “conspiracy of silence” as regards the mention of painted vases to which Greek literature almost universally adhered, the painted Panathenaic amphora is not alluded to, even in the prize-lists. But it does not follow that they were not given, any more than that the *argumentum a silentio* proves the non-existence in antiquity of all the painted vases known to us. To each winner of a prize entailing so many measures of the sacred oil, a painted vase would be given, in manifest of the honour he had achieved, and which, as the æsthetic symbol of his victory, he would preserve, and his heirs or his grave after him, long after the oil had been consumed. Such a proceeding could easily be paralleled, for instance, in the modern practice of providing a silver cup as the subsidiary prize for competitions of which the formal reward is a sum of money.

In the *Ἀθηναίων Πολιτεία*, ch. 60, some light is thrown on the proceedings in connection with the oil presented to winners in the Panathenaic Games. The athlothetae are to arrange the procession, the

* The latest is Heinze in *Bonner Studien*, p. 40 : cf. Stephani in *Compte Rendu*, 1876, p. 35 ; Urlichs, *Beitr. zur Kunstgesch.*, p. 54.

musical contest, the gymnastic contest, and the horse-racing; they are to arrange for the making of the peplos, and for the making of the amphorae (this in concert with the Boule), and to give out the oil for the competitors. This oil, from the *μορίαι*, is kept in the Acropolis in charge of the *ταμίαι*; at the Panathenaia they measure it out to the athlothetae, and the athlothetae measure it (*i.e.*, the prescribed number of measures) to the victors. Only the victors in the gymnastics and horse-racing receive oil: for the other contests other prizes are prescribed. Hence it is that (on the undoubted Panathenaic amphorae, at any rate) only gymnastics and horse-racing are represented.

From the above passage it seems to me clear that the measuring out of the oil is a separate duty from the making of the amphorae: the latter is in the same category with the preparation of the peplos: the same officials are to give instruction to the *ἀρρήφοροι* and *ἐργαστίνας* for the peplos, and to the vase-painters, whose duty it is to make the painted Panathenaic vases. The phrase *μετὰ τῆς βουλῆς* in this connection doubtless refers to a preceding passage in ch. 49, *καὶ τῆς ποιήσεως τῶν νικῶν καὶ τῶν ἄθλων τῶν εἰς τὰ Παναθήναια συνεπιμελείται (sc. ἡ βουλή) μετὰ τοῦ ταμίου τῶν στρατιωτικῶν*: where the term *ἄθλα* includes, no doubt, the painted amphorae with their inscription *τῶν Ἀθήνεθεν ἄθλων εἶμί*.

The Panathenaic amphorae of our museums, then, were never intended to serve a practical, but only a festal and symbolical, purpose: one such being given to each winner as representative of the measures of oil which, together with it, comprised his *ἄθλα*. This is surely more reasonable than to suppose that so many duplicate vases were presented to the victor, each bearing the same decoration and the same inscription, until he had sufficient to stow all the oil to which he was entitled.

Of course it is not necessary to suppose that the painted vases were given away empty: they would probably contain at least some of the oil; and thus Pindar's reference to the *καρπὸς ἐλαίας ἐν ἀγγέων ἔρκεσιν παμποικίλοις* is as accurate as poetical usage requires.

An interesting comparison with the mosaic on Plate XVI. *a* is offered by a mosaic, also from Delos, of which a cut is given from a drawing by M. Salomon Reinach, in *B. C. H.* viii. (1884), p. 177. This mosaic represents almost identically the same subject as ours; that is to say,

an amphora upon a square pedestal, with a wreath lying beside and a palm-branch behind it; on the left is an object which M. Reinach describes as "tablettes" (?). Judging from the inscription upon it and from the style of the border, the design must be considerably later than ours; but I cannot help thinking that certain inexplicable details are due less to the lateness of style than to the copy. Probably the mosaic was none too clear, and if M. Reinach had realised that the amphora is a Panathenaic amphora, and the "tablettes" a victor's tainia, his copy might have been modified to some extent. In any case, it looks as if the artist employed by Publius Satricianus had taken a hint from the much earlier design here published.

II.

In two cases which have come down to us, Panathenaic vases bear the signature of an artist (Sikelos, Klein, *Meistersig.*², p. 86, and Kittos, *Brit. Mus. Cat.* ii., B 604). This fact has led some authorities* to suppose that these vases could not have been given away with the sacred oil. But does it follow? The Kittos amphora was found at Teucheira, in the corner of the cemetery which yielded all the other specimens obtained by Mr. Dennis from this site, and which he considered to be a kind of "victors' corner," a plot reserved for those illustrious dead who had won honours at the Games.† It bears the usual inscription recording that it is one of the prizes from Athens; and I cannot see that it is more inappropriate for a vase-painter to sign a Panathenaic prize or even to put on one the kalos name of Euphiletos (*Brit. Mus. Cat.* B 134), or on another that of Hippokles (among the Acropolis fragments), than it was, for instance, for Pheidias to put Pantarkes kalos on the thumb of his Olympian cult-statue, or for any lesser artist to sign one of the thousands of ex-voto statuettes which stood in the temples of antiquity.

To the number of signed Panathenaic vases, I am now able to add a third example, of which Plate XVI. *c* is an illustration (in two-thirds actual size). It is, unfortunately, only the fragment of one side of an

* So von Rohde in Baumeister, *Denkm.* p. 1974.

† Dennis in *Trans. Roy. Soc. Lit.*, Ser. 2, ix., pt. i., p. 170.

amphora of the average Panathenaic size, but sufficient of the original is preserved to render its identification certain. It was found at Eleusis, in 1888, in excavating the earth which contained the Byzantine ruins ("εἰς τὸ χῶματι τῶν Βυζαντινῶν χαλασμάτων"), and lies, with a series of fragments of other Panathenaic vases, in a table case in the Eleusis Museum. I am indebted to Mr. Philios and the authorities of the Central Museum for the permission to publish it here.

The fragment forms part of the upper right-hand side of the obverse design of the vase. On the r. is seen the upper part of the column, with engraved lines indicating perhaps the volutes of an Ionic capital, and the prolonged abacus which no doubt had supported some object, of which, however, no part is preserved. On the l. is a part of one of the pteryges of the himation of Athenè, which was probably hanging from her uplifted r. arm. Between it and the column is the inscription, the letters of which are arranged kionedon ος ἐπόησε. The folds of the drapery are indicated by engraved lines, and a white border runs along the lower edge.

It is a great pity that the fracture was not so arranged as to give us at least one more letter of the artist's name. As it is, it is difficult to decide whether the fragment belongs to a second vase by Kitt]os, or is the work of some other artist. A comparison with the Kittos amphora makes it probable, for reasons of style, that the latter is the case. The character of the drawing in our fragment is much more accurate and careful than that of Kittos; and the Athenè of Kittos does not wear an himation.

The form of verb used by Kittos is ἐποίησεν; in our fragment it is ἐπόησε[ν];* and though the shapes of the letters in the two vases appear generally to correspond, the superiority in glaze and technical finish of the new fragment mark it as slightly the earlier of the two, though the difference of date cannot be much. De Witte (*Annali*, 1877, p. 310) distinguishes between those amphorae which have the inscription parallel to the columns and those in which it is kionedon; the Kittos vases, by this test, would be subsequent to B.C. 347; I am inclined to doubt, however, whether we have sufficient evidence to warrant us in

* For this form, see Kretschmer, *Gr. Vasenschr.*, p. 130; Meisterhans, *Gramm. d. Att. Inschr.*, pp. 44—5. It is found already in the sixth, but is especially frequent in the fourth century B.C.

accepting this test; on technical grounds it would seem more natural to assign the Kittos vases and our fragment to an earlier date.

There is one feature in the Eleusis fragment which is, so far as I know, unexampled; that is, the position of the inscription. In all other Panathenaic vases the inscriptions, whether parallel or kionedon, start from a point below the abacus of the column. But here the level of the abacus comes between the two final letters of the first word, which must have started from nearly the top border of the design. Possibly the artist in this case added his ethnic Ἀθηναῖος and started in this unusual way in order to leave himself room.

III.

Plate XVI. *b*, contributes a new and interesting variation of the formula usually found in the official inscriptions on Panathenaic amphorae. It represents (also in two-third scale) a fragment of one of these vases, which was picked up by Mr. Bosanquet in 1896, in Melos, on the site marked in the plan of old Melos (*Brit. School Annual*, ii., p. 64) as Graves, and I am indebted to him for kindly allowing me to publish it. It is now in the Museum of the British School at Athens. Of the correctness of its attribution to a Panathenaic amphora there can be no doubt; the size and character of the pottery, and the kionedon arrangement of the large letters, beside what appears to be undoubtedly part of one of the usual columns, combine to render this a matter of almost absolute certainty.

In place, however, of the inscription recording the name of the archon, we have here θετοντο At first sight it would appear that the letters must form parts of two words, the second of which is τούτο; but as it is highly improbable that a word should end in θε, it seems much more likely that we have here part of a single word, and that a present participle, θετοῦ(ν)το[ς]. The omission of the ν is by no means an unusual phenomenon, especially in Attic orthography. The disappearance of ν before τ is one of the most common instances of the dropping out of a nasal before a consonant; thus, in the François vase we have Ἀταλά(ν)τη; on a vase in

Palermo (*C. I. G.*, 7657), Δῖα(ν)τος; and on an Attic inscribed stone (*C. I. A.* i., 472), θανό(ν)τοι(ν).*

Of verbs ending in *θετέω* there is not a large selection, and as we are justified in assuming that the inscription has reference to some public official at Athens associated with the Games, our choice is practically limited to two alternatives,

Ἄγωνο]θετοῦντος τοῦ δεινός or ἀθλο]θετοῦντος τοῦ δεινός. As regards the second of these alternatives, a difficulty arises from the fact that the athlothetae were ten in number,† and it is unlikely that one only of the ten should have been selected for a purpose such as this. Moreover, it is not easy to predicate any historical circumstance which would account for the substitution of the name of one of the athlothetae for that of the archon eponymos. We are therefore led to the conclusion that the inscription must refer to some occasion when either (i.) special circumstances connected with the games in which the prize was given made it essential that the name of the agonothetes should be given; or (ii.) the name of the archon eponymos had been replaced in Panathenaic vases by that of other officials.

The above reading is rendered the more likely from the fact that one of the fragments of Panathenaic vases from the Acropolis, of which Dr. Zahn has been good enough to send me a drawing, has beside the column an inscription of which parts of four letters are preserved, . : —NOΘ The upper part of the first letter is broken away; from its position it must be either Ε or Ω. As it is on the level of the centre of Athena's helmet, there cannot be room for many letters before it; and I think we are justified in restoring the inscription as Ἄγ]ωνο-θ[ετοῦντος τοῦ δεινός. The style of lettering and drawing mark it as very late in the fourth century.

How, then, are we to account for the appearance of a new formula in a series of vases in which, as we know, hieratic tradition had played so important a part for upwards of two centuries? Two alternatives present themselves in explanation.

* Cf. Kretschmer, *Gr. Vasenschr.*, p. 161. As further examples, the following may be quoted: Μελα(ν)θίφ in *J. H. S.*, ix, 261; Ἐπρέκε(ν)θος in *Bull. Corr. Hell.*, 1898, p. 124; and lastly, as an instance in which I have a certain personal interest, Ἀπολλῶνος Ζμιθέως on a coin of Alexandria Troas of the second century B.C. (*B. M. Cat., Coins, Troas*, p. 11), to which M. Perdrizet has kindly called my attention.

† See e.g., Ἄθ. Πολ., ch. 60.

(i.) There is good reason to believe that the Panathenaic festival was in some cases celebrated elsewhere than in Athens itself. Athenæus (xii., 533) tells us that Themistocles established the Panathenaia in Magnesia; and the distinctive mention in *C. I. G.* 1068 of Παναθηναῖα ἐν Ἀθήναις certainly points to the same conclusion. Considering how closely the Athenian colonists seem to have identified themselves with the mother-state, and that the recurrent Panathenaic festival was, in a sense, the very festival of these patriotic traditions, nothing is more likely than that the cleruchi, who could not themselves go to Athens, should celebrate the Panathenaia in the homes of their adoption. But as most of these communities were poor, and the provision for games worthy to be called Panathenaia entailed great expense, it would have been seldom attempted, and that is probably why antiquity has left us so little record of such institutions. It needed that some citizen rich and patriotic should come forward—as Themistocles in Magnesia—to play the Averoff and defray the expenses of the Games, and in fact become the agonotheses for the time.

On such rare occasions it would doubtless be a point of honour with the *λειτουργός* to follow as closely as possible the Athenian model, and, that being so, Panathenaic prize vases for the Games would be one of the first necessities. These might or might not be made in Athens; but the familiar inscriptions would have to be altered; what is more natural than that the archon's name, unsuitable as a date-mark in the colonies,* should be replaced by the name of the agonotheses to whom alone the celebration was due?

Granting then that an agonotheses inscription may have the significance suggested, how does this explanation suit the fragment before us? Are we to regard it as part of a prize given in local Melian Panathenaia? I think not, for this reason: we have as yet no evidence of this usage of such inscriptions earlier than the fourth century B.C., and, in any case, the lettering and general character of our fragment would point to a date rather after than before the fourth century. Now we know that by 403 B.C., the Athenian domination of Melos had practically come to an end; and although it may be true that the

* It is true that the cleruchi sometimes had their own archon eponymos, as, for instance, at Delos (*C. I. G.*, 2270); but there can scarcely have been a large enough community of them in Melos in the fourth and third centuries to make this probable there.

Ionian stock continued to be an important element in the island,* it is hardly likely that a function so aggressively Athenian as the Panathenaic festival would be held in Melos after 403 B.C. We are thus brought to the consideration of our second alternative.

(ii.) The history of Athenian institutions shows us that in later times the charge of the Panathenaic Games was no longer in the hands of athlothetae chosen by the tribes, but was committed to a single agonothes. The evidence of inscriptions† goes to show that the offices of agonothes of the Dionysia and of the Panathenaia respectively were instituted in the last years of the fourth century B.C. It is thought that the latter office was instituted somewhat later than the former, because there are inscriptions about this period which speak of the agonothes of the Dionysia merely as ὁ ἀγωνοθέτης (*C. I. A.* iv., 2, p. 112): the inference, however, does not appear certain, because it is conceivable that in these cases the same person may have filled both offices. However this may be, we know that in *Ol.* 117, 4 (309-8 B.C.) Demetrius Phalereus both filled the office of archon eponymus at Athens and also presided over the Dionysia: it is quite possible that he may have joined to these functions that of agonothes of the Panathenaia; as archon eponymus, he would have the right of putting his name on the amphorae; but it is conceivable that in a matter connected with the Games, he would prefer to figure as the representative of the newly created office; we know that the ἐπιμελεία of the agonothes lasted for a year; and thus it may be that the custom originated for the agonothes, rather than the archon eponymus, to appear on the Panathenaic amphorae.

The change which is suggested for the Panathenaic amphorae will be more comprehensible if we bear in mind the parallel case of the Athenian coinage. Towards the end of the fourth century B.C., the coinage of Athens, which, like the amphorae, had continued to reproduce a uniform type for more than two centuries, comes suddenly to an end, and only revives after a century of absence. The reason ordinarily assigned‡ for this is the action of Antipater, who after the Lamian War

* See Homolle, *Bull. Corr. Hell.*, i. p. 48.

† *C. I. A.*, iv. (suppl.), 2, No. 421; ii., 3, No. 1289.

‡ Head in *Br. Mus. Cat., Attica*, p. xxxi.

(B.C. 322) enforced measures which were aimed against the democratic constitution of Athens, and which may have deprived her of the right of coining money in her own name. The substitution in the Panathenaia of the agonothetes for the athlothetae elected by the tribes would appear to be equally referable to this anti-democratic tendency; and it seems at first sight highly probable that the change would be marked by the inscription of the new official's name on the vase in place of that of the archon eponymos. But on the other hand we have evidence which proves that after the time of Antipater, Panathenaic amphorae were still being inscribed with the name of the archon: there exists in the Louvre collection an amphora bearing the name of Theophrastos, who was archon in 313 B.C. So that it is evident that we must assign a later date to the new departure; in any case, if we have to account for so marked a change in hieratic tradition, no epoch of Athenian history seems more likely than the rule of Demetrius Phalereus.

The Melos fragment naturally recalls another example, which offers an interesting parallel to it, that is, the fragment of a Panathenaic amphora published by Benndorf, *Gr. und Sic. Vasenb.*, Pl. 10. This fragment, found upon the Acropolis, gives on the right part of one of the usual columns, surmounted by a figure in short girt chiton, long laced boots and helmet (?) with staff or spear on l. arm, resting l. foot on a shield. Beside it is part of an inscription kionedon, which has been restored as Κοσμη]τεύοντος Εὐρυκλείδου. I have to thank Dr. Zahn for kindly sending me a new transcript of the inscription, which leaves no doubt as to the correctness of the restoration. Dr. Wolters has been good enough to add the following note: "Es ist sicher eine panathenäische Scherbe; der Zipfel des Gewandes der Athena ist erhalten (auf der Abbildung links unten, nur in Umrisslinien)." He also tells me that there is no Panathenaic fragment in the Acropolis series which can with certainty be placed at a later date than 313 B.C.

Judging, however, from the style of the Benndorf fragment, there is no reason why it should not be assigned to much the same period as our Melos example. We thus have at the close of the fourth century yet another official, the kosmetes, replacing the archon eponymos upon a Panathenaic vase.

The growing importance of the kosmetes in matters connected with

the Games is testified in numerous inscriptions of the third century.* In the Ephebic inscriptions he is often named immediately after the archon: and cases are known in which the agonothesia of different festivals was entrusted to the kosmetes.† It is therefore not surprising that when once the name of the agonothetes was allowed to appear on the prize vase, that of the kosmetes should also be found. Possibly the example before us may represent an occasion on which Eurykleides, whose real function was that of kosmetes, had undertaken the agonothesia of the Panathenaic Games.

It is clear that more than one of the annual magistrates at Athens, during the fourth century, at any rate, was officially concerned in the making of the prize vases: and the question arises, whether any indication of this is traceable on the vases themselves. The symbols which are placed on the columns on either side of the figure of Athene, and which in the fourth century offer such a variety of types, have never been satisfactorily explained.‡ Is it possible that these may be magistrates' symbols? A natural point of comparison is suggested by the symbols on the coins of Athens. Unfortunately neither symbols nor names occur on the coins before 220 B.C.; and though the general opinion is that they undoubtedly represent the 'emblème parlant' of magistrates, there is no general agreement as to which magistrates are thus referred to, nor as to the system employed.§

So long as the figure of Athene on the amphorae was turned to the left (*i. e.* before 336 B.C.) such symbols might be found on either of the columns or upon the shield. Thus on B. 605 in the British Museum (probably an early example of the fourth century) the group of Harmodios and Aristogeiton is placed upon the shield; it would probably have been found difficult to set it upon the narrow space of the columns, which consequently bear only the traditional cocks. Possibly the system was only gradually organised; and the change in the direction

* Dumont, *Eph. Att.*, i., p. 170. Foucart in *Rev. de Phil.*, 1894, p. 244, quotes an inscription from Rhamnus of the middle of the fourth century B.C., as giving the earliest mention known of a kosmetes; he considers that it confirms the reading *κοσμήτην* in Aristotle, *Ἄθ. Πολ.*, ch. 42.

† Dittenberger, *De Eph. Att.*, p. 31.

‡ Cecil Torr (*Rev. Arch.*, 1895, ii. p. 1) proposes to identify the figure on the column in the amphora of 313 B.C. as the orator Lycurgus. But this type must stand with the others, and it would be difficult to find a similar historical explanation of any other instance.

§ Cf. Head, *Br. Mus. Cat., Attica*, p. lviii; and Th. Reinach in *Rev. des Ét. Gr.*, i. p. 163.

of the figure of Athene may be due to this. At any rate, when once the figure turns to the right, a symbol closely recalling the magistrates' emblem of the coins, and sometimes two separate symbols, are found upon the columns.

It is a curious fact that, except on the Acropolis, very few Panathenaic amphorae, especially of the later class, have been found in Athens itself,* and yet there must have been many Athenians who won prize vases and had them in the ordinary course buried with them. In *B. C. H.*, i. p. 173, an interesting letter of Burgon is published, describing the circumstances of his discovery of the prize vase known by his name. From this it would appear that no less than four others were found in the same excavation, but unfortunately destroyed in ignorance. It looks very much as if the Panathenaic victors in Athens, as in Cyrene, had a special part of the cemetery reserved for them. Perhaps one day the Athenian "Victors' corner" of the fourth century may yet be discovered.

CECIL SMITH.

* At Delphi, one fragment of a Panathenaic vase was found in 1896, in the enceinte of the Pythian Apollo. M. Perdrizet has kindly given me the following description of it: "Il reste une partie du bras droit d'Athéna, et une partie de la colonne placée à droite de la déesse. Aucune inscription."

THE CRUCIFIXION ON A GREEK GEM.



THE gem of which an engraving (in twice the actual size) is here given is a carnelian intaglio, which I found in a private collection in London in 1895. The owner, a Greek lady, resident in London, brought it to me with a bagful of similar gems, all of which had been in her possession from childhood. It appears that as a child she lived with her family at Constanza (Kustendje), and that the children playing on the beach there used frequently to find and make collections of Greek gems washed up by the sea or lying among the sand and pebbles. Her collection comprised some thirty or forty, all of which undoubtedly date from the first to the third century A.D.; but this was the only one of real importance; it was bought on my representation by Sir A. W. Franks and presented to the British Museum, where it is now exhibited among the Christian antiquities.

The engraving above is reproduced from an impression, so that to anyone looking at the actual stone the relative positions of the figures are reversed and the inscription reads direct. The right-hand side (as seen in the engraving) has been partly chipped away, and a small fragment is missing from below and above the central figure.

In the centre is the figure of Christ crucified, his head turned to the right; the body stands rigidly *en face*, excepting the feet, which the artist, wishing doubtless to avoid a difficult foreshortening, has inclined to the right; they rest on an exergual line, which supports on

either side six figures of the apostles; these are of diminutive size, and each is draped in a short himation or pallium wound closely around the body. Over the whole design has run the usual Christian inscription * **IXΘVC**, the mystical fish-name composed out of the initials of the titles of Christ. Of the cross, only the two lateral arms are visible and a part of the upright between the legs of the figure: most unfortunately the absence of the fragment chipped away above the head leaves it uncertain whether or no the upright was continued higher than the arms. From a close inspection of the fracture, I am inclined to think it was not, and that the form is **T**. The lateral arms of the cross are not represented in one continuous straight line, but appear to be made in two pieces overlapping each other; this however may be an accidental effect merely due to the want of skill of the artist. In order that these parts of the cross may be clearly seen, the arms of the figure are not represented in the ordinary way as lying along the wood, but are extended at their full length below, as if fastened to the cross by the wrists.

Before proceeding to a brief discussion of the details of this scene, let us consider what other representations of the crucifixion are already known which offer any points of comparison with this. The two usually quoted as the earliest are the scene on the doors of S. Sabina in Rome,† and the relief on a panel of an ivory casket from the Maskell Collection, now in the British Museum.

In the S. Sabina rendering three men, nearly nude, wearing only a very small shirt, are represented in the attitude of crucifixion, the hands nailed, but not the feet: the central figure of Christ is represented as much the largest in size: in the background is architecture, representing probably Jerusalem. The lateral arms of the cross may possibly be indicated by cross-pieces at the ends, but as to this authorities differ. The cross has certainly no fourth limb indicated at the back of the head.

The Maskell ivory panel has a **T**-shaped cross, with splayed extremities; the hands are nailed and apparently the feet (which are not crossed) also: the figure has a very narrow loin-cloth and a nimbus;

* The apex of one limb of the I is visible on the gem, but is not shown in the engraving.

† Dobbert, *Zur Entstehungsgesch. d. Crucif.* p. 2.

immediately above the head is a label inscribed **REX IUD**. The figure is raised nearly half its height off the ground. On the left is Judas hanging from a tree, then Mary, and next the cross John; on the right of the cross Longinus. The casket to which this panel belongs is now conclusively proved to be not later than the sixth, and is probably of the fifth century A.D.

The three Monza relics,* which are probably all earlier than 599 A.D., all represent the figure of Christ wearing a sort of colobium, and evidently show a considerable advance towards the formulation of the type. The cross, however, is still T-shaped, but the lateral limbs are not always discernible; in all of these there is a label above the head.

Kraus (*loc. cit.*) refers to a gem which he says is in the British Museum; he describes it as very rough, but as representing the figure of the crucified without the cross, the head encircled with the nimbus; beside him two figures, and above an inscription which is illegible. The writer is probably wrong in his statement that this gem is in the British Museum; I have failed to trace it in any of the Museum collections.

The closest parallel to our gem is one which is figured in Garrucci, *Storia*, vi., Pl. 479, fig. 16. On p. 124 he describes it as a "bellissima corniola . . . stata già del Dottore Nott, noto collectore in Roma." It represents Christ apparently quite nude, on a narrow pedestal with abacus, like a column, with arms extended on either side, and nimbus around head. On either side, six small figures representing the apostles standing on an exergual line. Below the arms the letters (retrograde in the impression) **EHCOXPECT**; in the exergue **OC**, and between them a lamb to 1. The inscription stands for *Ἰησοῦς Χριστός*. This gem evidently represents a slightly developed form of our type, and, judging from the style and forms of the letters, must be of very nearly the same date.

If we now examine the details represented in the above list, we see at once that there are certain points which are characteristics common to the whole of these earliest representations of the crucifixion.

The first and most noticeable feature is the T-shaped cross. That

* See Kraus, *Real-Encycl. s. v.* "Kreuzigung."

this was the earliest form in which the cross was represented we see also from other evidence; Clemens of Alexandria, *Stromat.*, vi., 11, describes the **T** as τοῦ κυριακοῦ σημείου τύπον: in this form, the *crux commissa*, it is also found in some of the earlier Christian inscriptions; thus the inscription of S. Callisto and that of Irene (*Bull. Crist.*, 1863, 35) both have it.* In the representations of the crucifixion, however, especially in those of minute dimensions, difficulty was experienced in indicating the lateral arms of the cross, as well as the arms of the figure; in our gem we have seen that a compromise was effected; this method, however, was probably not felt to be successful, for in subsequent examples the artists are content to leave them unrepresented, so that the arms of the cross are suggested merely by the position of the arms of the figure. It is probable that the **T**-formed cross did not continue as the recognised type much later than the middle of the fifth century, for the coins of Galla Placidia (A.D. 450) have the fully developed four-limbed cross: those struck at Ravenna have the monogram of Christ formed of a St. Andrew's cross laid upon the stem of a **P**: and those struck at Constantinople have the figure of Victory or an angel holding a cross *potent* with elongated stem in her hand. The same form of cross occurs further in the intaglio on a bronze ring, published by Mr. Drury Fortnum;† a draped figure of Christ (?) with nimbus stands looking at the cross which rests on or springs from a bunch of grapes; this ring comes from Athens, and can hardly be much later than the coin of Placidia. Probably when the custom arose in art of representing the superscription, it was found necessary to add a fourth limb on which this could be fastened; the transition stage is shown in the Monza relics and in the Maskell ivory, where the superscription is represented immediately above the head of the figure, but attached to nothing. The addition of the fourth limb had this further advantage, that it assimilated the form of the cross to that of the **X**, the initial letter of *Christos*.

In most of the above instances the figure of Christ is nude or almost so. I am inclined to believe that the tendency to drape the crucified

* The same form of cross occurs also in the Alexamenos graffito of the Palatine: it is noticeable that there also the arms of the figure are drawn *under* the lateral arms of the cross, and the feet of the figure rest on the ground, as in our gem.

† *Arch. Journal*, xxvi., p. 137, No. 26.

figure came in only at a later stage. After all, to the Christians of the first centuries, with their semi-classical traditions of art, there was nothing revolting or unseemly in 'heroic' nudity, and there was on the other hand the actual narrative of their own gospels, which certainly leave no room for doubt on the point. "They parted my raiment among them, and for my vesture they did cast lots." Possibly the draped type may have arisen in Byzantine art, with its less classical and more Oriental notions. At any rate it is certain that in our gem and the Nott gem the figure is nude; and that this is intentional is shown by the fact that the subsidiary figures in the scene, though on a smaller scale, are clearly represented as draped.

In our gem the figure of Christ is indicated on a much larger scale than that of the apostles: this may be partly the result of a kind of atavism of the decadent art reverting to the rudimentary device of early Egyptian and Greek art, in which relative importance is expressed in terms of relative size. But I think there is also another reason; the earliest Christian art has not yet learnt to formulate the type in which the crucified one is 'lifted up' on the cross. In our gem the feet of Christ are on the same level with those of the apostles; and in order to distinguish his figure from theirs it is necessary that it should be increased in scale. The S. Sabina relief adheres to the same principle; but in the Nott gem a transition stage is shown: here the figure of Christ, only slightly larger than that of the apostles, is distinguished by being raised on a kind of column; subsequently the column is absorbed into the stem of the cross itself, and its abacus becomes the *suppedaneum*, the support on which the feet rest.

Writers on Christian art of a certain class have been in the habit of asserting that representations of Christ, in any form, and especially in that of the crucifixion, are unknown in the early centuries of our era. The above list of examples is sufficient evidence in refutation of this error, which probably arose from the fulminations of the early fathers against the practice; Justin Martyr, Clemens, Origen, Tertullian, and many others have left abundant evidence of the prejudice felt by the orthodox mind against any materialisation of the Divine: so much so that the Council of Elvira (between 310-324 A.D.) expressly forbade that what is worshipped should be depicted on the walls. Possibly the good fathers felt the danger of the seductive influences of Pagan art;

in any case, they were for the most part themselves influenced by their Eastern surroundings, where the tradition voiced in the second commandment has always lingered: "thou shalt not make thee any graven image, or any likeness of anything that is in heaven above." But the mere fact that the Church authorities in the fourth century raised such an outcry against the representation of the divine image shows that the evil (if evil it was) was very prevalent; and when we consider that the apostles in their teaching gloried in the crucifixion we may be sure that this would be an appropriate subject in early Christian art.

From the detailed analysis above made of the instances given, it is clear, I think, that our gem represents an earlier stage of the crucifixion than any of the others mentioned. Judging from the style of the gems found with it, it can hardly be later than the third century of our era. As I have already pointed out, the nearest analogy to it is offered by the Alexamenos graffito of the Palatine; this graffito is usually assigned to the second century, and I see no reason why the gem should be much later in date. In any case, I think we may fairly claim for it the distinction of being the earliest rendering of the crucifixion that has yet come down to us.

CECIL SMITH.

MACEDONIAN CUSTOMS.*

NO one who visits any corner of Turkish Greece can fail to be struck with the closeness of the links which bind it to free Hellas; he will find not only that the language and religion are the same, but that an identity of manners and customs exists, both in society at large, and also among those families which have happily survived the Turkish domination. A strange point is that certain ancient customs, which are to-day represented in no part of free Hellas, are still kept up and flourish in Macedonia.

As to the general subject of Macedonian customs, I am not aware that any book has yet appeared dealing with it; and I have, therefore, undertaken this short study, with the desire of doing what lies in my power to make known the customs of my own country. The undertaking has been hampered with two unforeseen difficulties; first, the fact that, so far as I am aware, there exists no literature of the subject, either Hellenic or otherwise, of which I could avail myself; and secondly, because, for obvious reasons, I was unable to enter Macedonia, and was therefore unable to prosecute those researches on the spot which were absolutely necessary for my study. Nay, more, such was the disturbed state of affairs, that even the inquiries I addressed in writing to correspondents who could have thrown light on doubtful points failed to elicit any response.

[*The task of collecting and recording remarkable instances of modern Greek folk-lore and customs appears to be an object which may usefully occupy the attention of members of the foreign schools at Athens.

The writer of this article is a Greek lady who was attached, during the past season, to the British School, and who, by her attainments, no less than by the circumstances of her nationality, is peculiarly fitted for the work she has here undertaken. I hope that this may be the beginning of many valuable studies of the same kind.

The only assistance which I met with in my work has been the valuable information which my mother placed at my disposal out of the rich stores of her memory, and the suggestions she has offered whenever it happened that a Macedonian custom seemed to offer a similarity or analogy to a custom which was general in antiquity.

Begging, therefore, the indulgence of those who may read these few lines, I pass to a description of the more important customs bearing on that critical period of human life, birth.

The arrival of an infant into the world is the occasion for manifold precautions and curious customs, which, with slight variations, are observed in every part of Macedonia. Some days prior to the birth, the mother that is to be takes a votive candle, and (if she is well-to-do) some other gift, and goes to the church of St. Eleutherios, in order to procure from the Saint a safe delivery. The cult of St. Eleutherios in most, if not in all parts of Greece, has taken the place of that of Eileithyia. At Athens certainly the little Byzantine church of this Saint beside the Metropolitan Church lies close to, if not actually on, the site where lay, according to Pausanias (I., xviii.), the temple of Eileithyia. When the danger is past, she testifies her gratitude once more by a dedication, bringing herself, or (if her health does not permit of her going out) sending a gift proportionate to her means and social position. These gifts, termed *Τάμματα*, are hung upon the eikon of the Saint, so that the interior of the church reminds one of the aspect which temples of Eileithyia and other deities must have presented in antiquity. The material of which such offerings consist is various. As in the case of other Saints, so with this one, the custom obtains that women having need of the saintly protection pass a night in the church, it not infrequently happens that history repeats itself, and that scenes are enacted which recall the amusing description in the *Plutus* of Aristophanes.

The memory of St. Eleutherios is most carefully observed by those who are about to become mothers; the vigil is reverently kept, as is also the service appointed for the day consecrated to his memory (December 15/27), on which day they refrain from all work.

Another Saint, whose protection is sought after by the more superstitious matrons, is St. Symeon (*Συμεών*). According to popular idea, the name of St. Symeon has curiously enough been connected with

the word *σημείον*, although, of course, there is obviously no connection between the two words, as the orthography shows; but the result is an unshakeable popular belief that those women who do not suitably keep St. Symeon's day (February 3/15) may expect to bring into the world blemished children (*παιδιά σημαδευμένα*), that is to say, crippled, hunch-backed, six-fingered, and the like.

As soon as the child is born a red sash is fastened up on the outside of the house door, to distinguish it from other houses. A ribbon of the same colour is tied round the thumb of the right hand, and on the head-dress of the mother, as a protection against witchcraft. The reason is that it is thought that the incomer will be attracted by the gaudy colours and the other decorations which she bears on her head, and not to her sight. For the same reason the more cautious folks will fasten upon the veil (*κρήδεμνον*) of the mother and on the baby's cap (*σκούφιας*) a sprig of garlic, which is regarded as an infallible remedy against witchcraft; so much importance is popularly attached to this, that almost every ailment of the mother or of the child, of whatever nature it may be, is at once attributed to witchcraft of the eye. Thus it happens that there is no question of enquiry into the nature of the disease affecting the mother or child; and in this simple but unshakeable faith one cannot but be reminded of that faith which led our ancestors to attribute all cases of sudden death to the shafts of Apollo and Artemis.

It is considered a precautionary measure against witchcraft that anyone visiting the patient should spit thrice in the direction of the mother and child, and that anyone who is afraid of witchcraft of the eye should spit into his lap: that this precaution has survived from very early times we see, for instance, from Theocritus vi., 39.

“ὡς μὴ βασκανθῶ, τρὶς εἰς ἐμὸν ἔπτυσσα κόλπον.”

If, however, in spite of all these precautions, the mother or the child should nevertheless be subjected to witchcraft, there exist numerous methods potent for its cure. First of all, the priest of the district is called in, to read the proper prayer ordained for this purpose by the Church: but the efficacy of the prayer is strengthened by supplementary measures; thus, it is essential that a fragment should be procured of the apparel, or something analogous, belonging to the supposed enchanter: and when this is burnt the spell likewise

turns to smoke. In other cases it is important that, if possible, some spittle from the mouth of the enchanter should be conveyed to that of the enchanted.

The first bath of the infant, which is given immediately after birth, must above all things contain a quantity of salt, in order that the child may become a “νόστιμος ἄνθρωπος,” that is to say, an agreeable person. To this custom is owed the origin of the proverbial expression “saltless” (ἀνάλατος), as applied to an individual, signifying that he is not pleasing or good-natured. Whether this custom existed or not in antiquity I am unable to ascertain; it is highly probable that it did, seeing that to-day it is a general custom throughout the whole of Greece. Mr. D. Kampouroglou, in his important work “Ἱστορία τῶν Ἀθηναίων,” refers to it as existing so far back as the fourteenth century.

Into the bath it is customary to throw gold and silver coins as presents for the person giving the bath. Afterwards the child is rolled tightly up in swaddling clothes, just as were its ancestors twenty centuries ago. On a well-known sepulchral relief in the Central Museum, for instance, a swaddled infant is represented as being brought by the nurse to its dying mother to say farewell to it; this might be taken as an exact illustration of the modern method of wrapping an infant.

Every mother preserves the umbilical cords of her children after they are cut off, putting them all carefully away in the same place, in the belief that by this means harmony and affection will be established among the children.

The first sustenance taken by the mother is very sparing and not as nourishing as it should be. For from five to six days she is given a kind of milk-rice, into which, in place of milk, there is poured the juice of boiled almonds. To the child, before it is allowed to taste its mother's milk, is given a drink of boiled water with ἀνηθόσπορον; this beverage is prepared generally by the mother, who is not allowed to drink water for the first two weeks.

After sunset no one is allowed to enter the house where the birth has taken place, for fear lest Nereids (Νεραΐδες) should come in with him, those sprites of evil so much feared by the people. For the same reason it is not permissible to leave out, during the night in the open air, any clothing belonging to the mother or child; if through carelessness

such a thing should occur, some misfortune is bound to happen to the owner of the clothes. A special precaution against the Nereids consists in arranging that the child should be put early to bed, and should on no account remain awake later than nine at night, because the Nereids are probably lying in wait to take its life. To neglect of this precaution by the mother or nurse are attributed most of the sudden deaths occurring among infants.

The third day after the birth is regarded as highly important, as having the greatest influence on the child's future, because during this day—or rather usually during the night of it—there takes place the visit of the Fates (*Μοῖραι*). The Fates, as in ancient times, are three in number; they visit the babe in order to bring it gifts, which are beneficial or the reverse, according to the good or bad disposition of the giver. From daybreak there is an unwonted stir in the house, caused by the arrangements for a friendly reception of the Fates. First of all comes the preparation of the famous *τηγγανίται*, a sort of cake, compounded of flour, butter (or oil), honey, and cinnamon, of which it is necessary that all the household and visitors should partake. Beside the child's pillow is placed a plateful of these cakes for the expected Fates, who it is hoped will prove friendly if they find the *τηγγανίται*. The child is dressed in its Sunday clothes, with gold coins and small decorations on its cap; and the mother herself binds around her head her most costly head-dress (*κρήθεμνον*), on which are fastened various decorations, such as rings, little brooches, crosses (the child must wear no cross until it is baptised), gold coins, the so-called *φλωριά*, &c.: without omitting the red ribbon and the garlic mentioned above.

In the evening all these decorations are placed under the pillow of the child and that of the mother. Mothers of weaker nerves and lively imagination are apt to assert that they have seen with their own eyes enter the bedchamber about midnight three stately women, who stood beside the bed of the infant. At this critical moment it behoves the mother to remain absolutely silent, otherwise she runs the risk of altogether losing the power of speech.

The above custom is very analogous to one which obtained in Athens, and which Phintikles, in the "*Μνημεία*" of Kampouroglou, records under the title, "Preparation for the Reception of the Fates," as having taken place in Athens about A.D. 1450. He says:—

“In the evening of the third day after the birth of the child the household prepare in the middle of the house a table for three persons, placing on it a jar of Hymettus honey, three almonds, an entire loaf, and a glass of water : they also lay out valuable ornaments of all kinds, a small pearl, and the husband’s purse ; and fasten up the house-dog. If the infant be a boy, they add a book and a knife (in order that he may become well educated and manly) ; if a girl, a ball of wool and a distaff. And around the table, which is purposely low, three cushions are placed, in order that the three Fates may be seated. The woman is attired in a golden wrap, and the babe is placed near her. The reason is, that on this night they think the Fates come, to assign to the child its fortune, and the mother remains all the night in fear and trembling. On the following day they sprinkle water in the four corners of the house.”

Until the third day the removal of any object out of the house where the birth has taken place is to be avoided ; and a lighted lamp or candle must not be brought into or out of the room. During the same period on no account must the mother and child be allowed to remain alone in the room ; if the necessity should arise, they can travel together, even when the child is in its infancy. What the reason is for this superstition I have not been able to ascertain ; it appears, however, to have some connection with the visit of the Fates. On the third day the nurse takes the mother, under whose arms she has placed a loaf of bread, salt, and three onions—these the mother must hold tight—and, covering her face with a white linen cloth, leads her around the rooms of the floor on which she happens to be walking herself with her face turned towards the mother, and whispering various prayers, while at the same time she sprinkles the floor with water which she carries in a jug. After this ceremony the mother returns to her bed, and can henceforth safely remain alone with her infant.

This curious formula does not take place in cases where it happens that for reasons of health the child has to be baptised on the day of its birth.

The mother must not look into a mirror until the fortieth day ; equally she must avoid looking, even from a distance, upon another woman recently confined. Neither must the infant be placed before a mirror until it be a year old, because the belief exists that in the

event of such a contretemps occurring the infant will have a younger brother within the year.

According to a curious and injurious custom, women are allowed to visit the mother a few hours and sometimes immediately after the birth has taken place; such visitors at their departure must leave a part of their dress, if it be only a thread thereof, upon the bed, accompanied with a wish on behalf of the mother for "milk," on behalf of the child for "sleep."

It is proper that all the relations, neighbours, friends, and acquaintances of the family should send, within the first forty days, cakes, a portion of which are offered to the visitors.

Baptism ought, above all things, to take place within the first few days, and on no account later than the fortieth; this urgency is due to reasons of religion. At the ceremony the mother must not be present, but must remain at home; or, if the baptism takes place in the house, she must stay in another room, where they hasten to announce to her the child's name. When the baptism takes place in the church, the announcement of the name becomes a more formal function, for then numerous children wait in front of the church until the ceremony is concluded and they have heard what name is given, and immediately run to the house with shouts, striving which shall be the first to make the name known to the mother; in return for which she gives them small silver coins. Similar coins fastened on ribbons, or others specially prepared for the occasion, with a representation on one side of the birth, and on the other the baptism, of Christ, are distributed to all the invited guests by the sponsor, in remembrance of the event, and are called "*μαρτυριάτικα*."

On the fortieth day the mother goes with her child to the church, where the priest reads a special prayer on their behalf. This custom is performed in memory and in imitation of the visit of Mary and Christ to the Temple, which took place, according to the orthodox church, on the 2nd February, or forty days after Christmas.

After the prayer of the fortieth day, which serves so to speak as a leave of exit for the mother, she, accompanied by the nurse bearing the infant, visits the more intimate relations and friends, who offer to the child bread, an egg, and a quantity of sugar, or some sugared object, accompanying these gifts with suitable good wishes.

The above notes are such as I have been able up to the present to collect as concerning the first stages of childhood; most of the customs which are commonly found among all Greeks I have omitted, as being known from other sources. I hardly dare hope that this humble contribution may be of use, but I trust it may serve as a very small recognition of the good work of the British Archæological School in Athens.

H. TRIANTAPHYLIDES.

PROF. JANNARIS' HISTORICAL GREEK GRAMMAR.

OF the writing of Greek grammars there is no end, and the reading of them is a weariness to the flesh. Most of them are unpractical enough, and give the student imaginary things for real. How many a boy has been persuaded to accept as good Greek the whole of dear old *τύπτω*, as set forth in the paradigms ever since the first book printed in Greek—the Grammar of Lascaris—was constructed for the torment of the young! How often do rules piled upon rules obscure our sense of a living and real language! It is not, therefore, easy to persuade men that have a long and daily habit of reading Greek to turn back to a grammar, unless they are obliged to look for that most idle of all knowledge—theoretical rules to set down upon examination papers. Yet Prof. Jannaris has overcome this strong repugnance in me, and I labour at his very voluminous and intricate book with profit, and with an interest I never before felt in such a book. Not that he persuades me of all his theories—far from it; but he attacks and strives to solve the standing problems which recur perpetually to the honest student of classical Greek, and which ought, we imagine, to have been long since solved. Yet the very length of the life of a problem may be evidence that it will never be solved, for it seems absurd to think that men could have been found to take opposite sides upon it for centuries without adequate grounds for each side, and the man who offers a final solution after many generations may find himself ranked with the honest proconsul, who called together the heads of the Greek schools of philosophy at Corinth, and advised them to settle their disputes in one final conference, at which he himself proposed to act as umpire.

On the other hand, there are such things as controversies which

do not last for ever. No one now contends for what was once hotly maintained, that Schliemann's discoveries have not determined the site of Homeric Troy; no one—except Mr. Gladstone—now maintains that one poet composed the whole Iliad and Odyssey, as we have them. We are not, therefore, wholly without hope that the question, for instance, of old Greek pronunciation, though long under dispute, may find its gradual settlement by the acquiescence of the majority of scholars in the arguments on one side. And this is the first question we are disposed to investigate in a book which professes to give us the historical development of old Greek into new. We could have guessed, *a priori*, which side Prof. Jannaris would take. A Greek of to-day who denied the direct filiation of anything now universal in Greece from classical ancestry would be indeed a *rara avis*, for never was patriotism so ingrained in any people. But we must confess that he sustains his ingrained prejudice with many sound arguments, and despite the fact that he reckons among his opponents so great an authority as Prof. F. Blass, of Halle, I cannot but think that he has made good his case. He does not, perhaps, lay stress enough upon some obvious arguments; for example, that the Romans, in the second century B.C., when they came to transliterate Greek proper names, wrote *Æschylus*, and not as R. Browning—who was fond of wonderful jargon—*Aischulos*, and so Phidias, *Æneas*, *Lycurgus*, &c., all of which approximate closely to the present Greek pronunciation. But Prof. Jannaris' arguments are far more elaborate. He shows from the enormous variations in the every-day spelling of Greek in inscriptions and early papyri that the correct style introduced (he maintains) by grammarians is artificial, and does not represent the actual speech of the people at any epoch. And he finds in authors, from Plato (in his *Cratylus*) downward, allusions which corroborate the view that, though not so old as accent, pronunciation, as it existed when Greek was brought into the West by the Renaissance (or along with the Renaissance, or to create the Renaissance), has a respectable antiquity, and had already been established in classical days. These are the general conclusions to be drawn from a forest of facts, especially drawn from the Greek of inscriptions, which might, perhaps, have been better co-ordinated; but then the reader would have lost the peculiar pleasure of seeking the proper inferences for himself. There is no need for me to crowd this

paper with special references to the pages of the book, as it is well indexed, and any serious reader can find for himself what he wants. But I do think it a pity that the whole apparatus of our ordinary Greek grammars should have been included in a book of which the importance depends upon special and peculiar views supported by special investigations. It is upon these, and the admirable analysis of the growth of the present Greek accent and syntax out of the Hellenistic idiom, that the book must stand or fall.

Let us return to the special questions which here interest us. The next great problem on which this book is well worth consulting is that of accent. In the first place, the at first incredible statement of old Greek grammarians that the proparoxytone is a natural limit determined by physical necessity—that is to say, that if a speaker of Greek put on the stress four syllables from the end of his word he would not have breath to finish it—this statement is justified by maintaining, and apparently with reason, that in Greek all syllables have an appreciable length and require some effort from the speaker, unlike English, where short syllables often drop their vowel altogether in pronunciation. We may say *centenary*; but also *cētenary*, which is nearly *centnary*, the second syllable being merely indicated. But a people pronouncing each syllable distinctly must find a difficulty in a series of more than two unaccented syllables after the word-accent. I think that is the case in German, except that grammatical flexions do not count in pronunciation so far as to disturb the word-accent, whereas in the more deliberate Greek pronunciation they do. We say in German *älterend*, and also *älterenden*, but I cannot remember an uninflected word which has fixed accent with three unaccented syllables following. Such words as *unbehülflich* are really in accent - ˘ - ˘ - ˘, not - ˘ ˘ ˘ ˘. But I am not discussing German accent further than to show how, even in modern speech, there may be more deliberation in the pronunciation of one tongue than another.

These things being so, Prof. Jannaris proceeds to declare unto us the most comforting doctrine that it is only pedantic scrupulosity of the grammarians to write several kinds of accents; that really circumflex and acute are one, and mean stress, not musical pitch. I think his arguments against the advocates of musical pitch are perfectly sound, and I might add to his arguments (1) that any attempt to read by

pitch which I have ever heard was a complete failure; (2) that the extant remains of old Greek music, with the words attached, show no fixed disposition to raise the note of the tune when the word-accent occurs, which they might be expected to do had the accent really been pitch-accent.

But the real "stress" of the question is its bearing upon Greek metre. If, as seems now certain, the accents put on our Greek texts by the Alexandrians, when Greek became a world language, and foreigners were at a loss how to pronounce it—a sensible device which, if copied by the English, would make their tongue flourish over the world—if, I say, these accents represent a most ancient pronunciation, which goes back to prehistoric times, how is it that our oldest metrical Greek (the Homeric) poems are composed in complete disregard of accent, and on a different principle, that of quantity? Under any supposition we can make, this conflict of accent and quantity is the greatest puzzle bequeathed to us by Greek literature. All the accents are persistent, and people seem always to have put them on their words where we find them. But turn to any Greek poet, from Homer to Nonnus, and you find accents totally disregarded. This metrical contempt is most completely shown by the fact that there are in almost any page of Homer lines where the accents and the long syllables do coincide. Such cases must have plainly suggested to the poets what the effect of such agreement would be, and yet even with these examples before them nine out of every ten lines violate the accentual stress.

It used to be thought one way of escape to make the accent a pitch accent, while putting the stress on the long syllables, but I have already said that I never heard any such attempt without complete failure; either the metre was lost, or the accent obscured. Thus we are driven back upon the old difficulty. How can the Greeks, who spoke by accent, have possibly hit upon a national system of metre which distinctly violated their ordinary pronunciation at every turn, and how can there have existed from the beginning another system of pronouncing, that by long and short syllables, which seems to have been preserved to us at first by metre, afterwards by orthography (long vowels, diphthongs, position)?

This is the problem which Prof. Jannaris attacks, and for which he offers us a new and startling solution. The reader who desires to

find its clearest statement will find it in section 9 of Appendix II. (pp. 528-9), and I request him to compare it with what I say, for an author should be judged at first hand, and not from the mirror of any critic. According to Prof. Jannaris, what we call quantity is not original to Greek, which in its earliest literature knew only metre and accent. When grammarians came to set down in writing, and for educational purposes, their old national poetry, they found such strong variations and conflicts between the spoken words and their treatment in metre that they devised various methods of marking the syllables long in metre, which were not habitually accented in ordinary speech, either by doubling the adjoining consonant, so as to produce what is called length by position, or by adding a vertical stroke after the vowel, which latter device actually gave birth to the diphthongs *αι ει οι υι*! and also by the long vowels **Η** and **Ω**, which, as is well known, do not appear in old inscriptions. Thus the so-called quantities, which tormented our youth when we were striving to write Greek verses at school and college, are, after all, a late and artificial invention of grammarians in the fourth century B.C., who sought by this means to teach and interpret the metre of the traditional epics. But whence or why did the epics hit upon a metrical system in violation of the accents, especially when they were not bound by tradition to recognise any syllable as long, apart from its position? To this vital question I have found no direct answer in the book before us. The indirect answer seems to be that the origin of Greek epic poetry belongs to a long past, indeed a prehistoric age, which we can no longer interrogate, but which evidently contained conditions quite foreign to those of the historical Greeks. And this answer postulates a far greater antiquity for the Homeric poems than I am disposed to admit. This conclusion seems to follow from the assumption that writing is very old in Greece, for which the eight arguments produced (pp. 22-3) are all very weak. By some curious oversight it is even alleged that the great Gortyn inscription comes from the seventh century B.C. There is no clear proof that writing, at least fluent writing, was of early use in Greece, and the Homeric poems do not seem to me divided by any great gap from Archilochus and the earliest lyric poets. Consequently it is difficult to understand how the metric of Homer should have been so strange as to require an artificial rehandling of Greek orthography, and an artificial establishing of long syllables,

which had meantime been recognised and adopted in all the lyric metres.

But it is quite possible that Prof. Jannaris may yet give us full explanations of these difficulties.

Let me repeat in conclusion that in explaining modern Greek forms the book is most ingenious and instructive, and here the author speaks with an authority which few of us can gainsay. This feature, in any case, should secure for him a distinctive place among Greek grammarians. But he takes liberties with our language which a foreigner should hardly take. He coins a crowd of new and strange terms, some of them very ugly, and yet his English, though marvellously good for one not a native, is not above criticism. Thus he often uses *relegate* in the sense of *bequeath*. But these trifles are of no moment to the sort of reader for whom the book is intended. A second edition might usefully be abridged in one direction, and expanded in another; but this latter the author will be required to do in any case when he comes to defend himself against the onslaughts which the champions of conservative views are likely to make upon him.

J. P. MAHAFFY.

ANNUAL MEETING OF SUBSCRIBERS.

THE Annual Meeting of Subscribers to the BRITISH SCHOOL AT ATHENS was held at 22, Albemarle Street, on July 15th, 1897, Sir EDWARD POYNTER, P.R.A., in the Chair. The following Report was read by the Hon. Secretary (Mr. GEORGE MACMILLAN) on behalf of the Managing Committee.

IN spite of the political disturbances, culminating in disastrous war, which have concentrated public attention on Greece during the last few months, the School has had a very satisfactory Session. The number of Students has been considerably above the average, and good work has been done both at home and in the field. Of the thirteen Students admitted, Mr. R. Carr Bosanquet, Craven Student of the University of Cambridge, went out for the fourth time, but unfortunately contracted malarial fever early in the Session, and was ultimately obliged to come home; Mr. Charles Clark went out for a second Session as Architectural Student; Mr. C. C. Edgar, Craven Travelling Fellow of the University of Oxford, and Mr. Duncan Mackenzie, of the Universities of Edinburgh and Vienna, were also admitted for the second time. The eight new Students were Mr. J. G. C. Anderson, of Christ Church, Oxford; Mr. J. W. Crowfoot, Hulmean Exhibitioner, of Brasenose College, Oxford, appointed by his University to the Studentship offered by the Committee; Mr. F. R. Earp, Scholar of King's College, Cambridge, appointed by his University to the Studentship offered by the Committee, but unfortunately prevented by illness from availing himself of the opportunity of going out to Athens; Miss C. A. Hutton, of Girton College; Mr. F. A. R. Morrison, Scholar of Jesus College, Cambridge, and Prendergast Student; Mr. W. W. Reid, holder of the Blackie Travelling Scholarship from the University of Edinburgh; Mr. Pieter Rodeck, holder of the Architectural Travelling Studentship of the Royal Academy; Mr. H. H. West, formerly Scholar of Trinity College, Cambridge; and Miss Helené Triantaphyllides, a graduate of the Arsakeion of Athens. Particulars of the work done by the several Students will be given in the Director's Report.

Mr. J. E. Brooks, a former Student of the School; Mr. J. L. Myres, formerly

Fellow of Magdalen College and now Student of Christchurch, Oxford; and Mr. Ambrose Poynter were admitted as Associates of the School.

The Students' Hostel, to which reference was made in last year's Report, has now become an accomplished fact. When upwards of £700 had been raised by private subscription, the Committee felt themselves justified in putting the work in hand. The foundation stone having been graciously laid by Her Majesty the Queen of Greece about the middle of January, the building was at once begun, and, under the active supervision of the Director, assisted by the local experience of Mr. Arthur Hill (who has thus once more rendered invaluable service to the School), and by the technical knowledge of Mr. Charles Clark (who has devoted much time and attention to the matter), the work has been pushed steadily forward, and the Hostel is now practically complete. During Mr. Clark's absence another Student, Mr. Pieter Rodeck, has also assisted in details of the building. It was hoped that, even with the furnishing, the total cost of the building would not exceed £1,200, but it now seems probable that as much as £1,500 will be required. The subscriptions to the Building Fund amount to rather more than £1,000, and the Committee invite further aid in order that, if possible, the scheme may be carried through without trenching upon the ordinary funds of the School. They are satisfied that this Hostel, the plan and arrangements of which have been very carefully considered, will add not only to the comfort and convenience of Students, but also to the efficiency of the School. A Sub-Committee has now been appointed to draw up regulations for the Hostel, in which it is hoped that Students will find better accommodation than has hitherto been available for them, and at a more moderate cost. The Hostel will be lighted with gas and the opportunity has been taken to introduce it also for the first time into the School building, which has hitherto been lighted with oil lamps. The gas will be at once more satisfactory and more economical. The Committee had hoped to light both houses by electricity, but the cost was found to be prohibitive.

In the winter and spring the excavations begun last season on the supposed site of the gymnasium of Kynosarges in Athens were carried to completion, with results which the Director will describe. The cost of this undertaking, it will be remembered, has been met by funds kindly placed at the disposal of the Director by private friends. After various difficulties and delays, work was resumed in Melos on the site of Phylakopi early in May, and carried on energetically for four or five weeks. There is now no doubt that the remains of an important prehistoric city have been discovered, the complete excavation of which, in a subsequent Session, may lead to results of first-rate interest. Particulars of the discoveries made in the past Session will be given by the Director.

The School being now in a position to plan its work in advance, the Committee have had under consideration several schemes for further excavation. It would be premature to make any definite announcement at present, but the Committee would wish subscribers to understand that in their judgment this is one of the most, if not the most, important branch of the School's operations. Not only is the actual work of surpassing value and interest to those who take part in it, but the material

thus collected affords abundant opportunity for subsequent research. Thus already the discoveries made in excavating the site of Kynosarges, and in Melos, have yielded enough to occupy students of pottery, of sculpture, and of inscriptions for some time to come, while the site of Phylakopi offers in itself a fascinating problem for the student of prehistoric civilisation in the Levant.

This subject leads naturally to that of the School Annual. Last year's issue, which was admittedly tentative, contained, besides the usual reports and accounts, only a few papers on travel and research of a slighter character than would be admitted into the "Journal of Hellenic Studies." The number recently issued, however, contains also certain papers which may be regarded as permanent contributions to archæology or to history. Two of these were contributed by well-known scholars who became Associates of the School and were good enough to make this acknowledgment of the privilege. Others were first-fruits of the abundant material supplied by the recent excavations in Melos. The fuller results of these and other excavations will be published, as opportunity offers, in the "Journal of Hellenic Studies." Thus the next number of the Journal will contain an article by the Director on Inscriptions from Melos, and another by Mr. Mackenzie on what is known as the "Three Churches" site; while articles on the Inscriptions, and on the Stelæ found at Kynosarges, are being prepared respectively by Mr. Anderson and Mr. Edgar. Mr. Bosanquet will describe the beautiful mosaic pavement found in Melos last year, with illustrations from the drawings made by Mr. Clark.

It is evident from this statement that so long as the School has excavations in hand there will be material enough for short preliminary papers in the Annual, and for more elaborate illustrated papers, such as members of the Hellenic Society expect to find in their Journal. In a word, the relation of the two periodicals seems likely, in the natural course of things, to become, *mutatis mutandis*, that which exists between the *Mittheilungen* of the German School at Athens, and the *Jahrbuch* published by the Institute in Berlin. That it should be possible to suggest such a comparison is in itself a very encouraging sign of the progress of archæology in this country.

The School has been able to procure in exchange for the Annual some important periodicals to which it had previously been necessary to subscribe. Among these may be mentioned the *Bulletin* of the French, the *Mittheilungen* of the German School, and the *American Journal of Archaeology*. The first number of the Annual was distributed gratuitously alike to subscribers and to others likely to be interested. This year, after reserving a certain number for subscribers, the balance has been offered to the public. As it becomes more generally recognised as the organ of the School, there is every reason to expect a steady demand for it, both from libraries and from individual archæologists, so that at least a part of the cost will be recovered. When it is remembered that every other foreign school in Athens has its own publication, and that this is, after all, a conspicuous sign of the School's vitality, the production of the Annual should be regarded as one legitimate charge upon the income of the School.

In the course of the Session considerable additions have been made to the Library, especially in the department of travel, which is intended to form the special feature of the collection. The sale of the library of the late Professor Overbeck enabled the Committee to acquire some books of special value and interest. Among books presented during the year may be mentioned the first three volumes of their great work on Ionian Antiquities, generously granted by the Society of Dilettanti, and the last instalment of the Illustrated Catalogues published by the Trustees of the British Museum.

New bookshelves have been added, and the library has been entirely rearranged by Mr. Edgar under the Director's supervision. The printing of the Catalogue is now nearly complete, and it is hoped that those of the other Schools in Athens will also be printed before long, greatly to the advantage of students. Before leaving the question of the Library, it should be added that the Committee have been in negotiation with the executors of the late Mr. George Finlay for the purchase of at least a part of his valuable library, and it is to be hoped that in next year's Report a successful issue may be announced. It may be necessary to raise a special fund for this purpose.

The special leave of absence granted by the Trustees of the British Museum to Mr. Cecil Smith, to enable him to act as Director of the School for two Sessions, has now unhappily expired, to the regret of all friends of the School. It has therefore been necessary to look for a new Director. The Committee have been fortunate enough to secure, for three years at any rate, the services of Mr. D. G. Hogarth, Fellow of Magdalen College, Oxford, a former Student of the School, and well known as an explorer in Asia Minor and Egypt. On his retirement from the post which he has filled with so much energy and success the Committee desire to tender their best thanks to Mr. Smith for his devoted service. The experience he has gained in Athens will still be turned to account for the good of the School, if, as is hoped, Mr. Smith resumes the seat on the Committee which he resigned in order to take up the Directorship. The Committee venture also to hope that the Trustees of the British Museum will find that their kindness in allowing Mr. Smith to absent himself for this purpose is justified by the larger knowledge and experience which he will bring to his duties as Assistant Keeper of his Department.

The Committee have to regret the loss of one of their number, Mr. Theodore Bent, whose recent death is a severe blow to the cause of archæological exploration. To the seat thus left vacant Professor Ernest Gardner, formerly Director of the School, has consented to accept nomination.

Mr. George Macmillan, who has acted as Honorary Secretary of the School since it was first opened in 1886, has found himself reluctantly obliged, by increasing engagements, to resign the office at the end of the current Session. The Committee have accepted his resignation with the utmost regret; but they feel that his labours throughout the twelve years of the active existence of the School have been so continuously and so unstintedly given that they cannot grudge him the relief for which he asks. They find it difficult to express their sense of the

debt of gratitude due to him by all supporters of the School. Only those who have worked with him through the early years of struggle and difficulty can carefully appreciate the extent of his services, the value of his untiring devotion and wise advice, and the eminent place he has taken in bringing the School to its present well-being. It is a satisfaction to the Committee to think that they will not lose the advantage of his presence among them, as he has allowed himself to be nominated for election to-day. Mr. William Loring, one of the most distinguished Students of the School, and also a member of the Committee since 1895, has consented to take up the work, and is to-day nominated for election as Hon. Secretary for the ensuing Session.

Turning to the financial position, the Committee has first to announce that the Government grant of £500 a year for five years was duly ratified by the House of Commons before the end of last Session, and the first instalment having been received, the finances may now be regarded as on their normal basis. The Hellenic Society have renewed for a further period of three years their annual grant of £100 a year. The total result of the year has been an addition to the funds of nearly £220; but this surplus is more apparent than real. The subscriptions to the Building Fund reached the sum of £1,074. This, though less than what was asked for, was sufficient to justify the Committee in proceeding with the building, and has been already spent, within a few pounds, in payments on account of the contract.* The final amount due on this head cannot be yet ascertained, but it is anticipated that, with the inevitable "extras," the surplus of £220 will be fully swallowed up, so that this addition to the funds is merely temporary. There will still remain the cost of furnishing to be provided out of the existing funds next year, unless special donations for the purpose are forthcoming. On the other hand, something will come back from the rent paid by students for the use of their rooms. The illness of the Cambridge Student for the year, Mr. Earp, prevented him availing himself of the £50 offered by the Committee; but this studentship has to be reckoned as a permanent charge on the income of the School. It is thus clear that the present resources of the School are barely sufficient to carry on the work on the present scale. As, however, it is difficult to see how any great reduction in expenditure can be made without some loss in efficiency, it is much to be hoped that new subscribers will come forward in order that the School may not be obliged to lose any part of the ground which its improved resources have enabled it to gain during the last two years.

As matters stand the Committee see no reason to be dissatisfied with the results of the past Session. Under circumstances of exceptional difficulty in Greece itself, the Director and Students have a good record to show of work accomplished or initiated. Indeed, it may be doubted whether during this particular year any other foreign school in Athens has got through so much. It is, of course, unfortunate that another change of Directorship should have had to come so soon, but in taking up the office Mr. Hogarth has the great advantage of previous familiarity with work of the kind both in Greece and elsewhere, and

* A further sum of £150 has been paid since the accounts were made up.

the Committee have every confidence in his zeal and ability. The main difficulty is still on the financial side. So long as the School has no permanent endowment it cannot enjoy entire freedom of action; the question of ways and means must continually interfere with its operations. For three years, at any rate, it can hold its own, though even during that period it could make good use of another two or three hundred pounds a year. But it must not be forgotten that the outlook beyond that period is uncertain, and that there is still an opening for the generous benefactor or benefactors who might, by a substantial gift, place the managers of an institution which has far more than justified its existence beyond any fear of financial anxiety. It behoves, therefore, all friends of the School, while rejoicing in the work that has been done, to keep its claims and requirements continually before the public, so that it may be understood how largely the study of classical archæology in this country depends, not merely upon the existence, but upon the increasing prosperity of the British School at Athens.

The adoption of the Report was moved by the Chairman in the following terms:—

Ladies and Gentlemen,—It is now my duty to move the adoption of the Report of the Managing Committee, which I do with great pleasure, but in doing so I cannot but make some apology for having undertaken to preside at this meeting. I assented to Mr. Macmillan's request that I should undertake this duty a long time ago, when I thought it would be an easy task for me to prepare an interesting and appropriate address for this occasion; but a greater pressure of work has fallen upon me than I could have anticipated, through the necessity of preparing the National Gallery of British Art, which Mr. Tate has presented to the Nation, for the opening ceremony by the Prince of Wales on Wednesday next. The hanging of the pictures in this gallery and other matters to which I am bound to attend have occupied my time of late so exclusively, that I have been prevented from turning my attention to the subject of this meeting, and this must be my excuse for coming before you very unprepared. Indeed, I ought to apologize for occupying this chair at all on an occasion when there are present so many archæologists and scholars, with a profound and extensive knowledge of Greek archæology and Greek literature: in no branch of which can I pretend to more than the merest smattering. My only excuse must be that I was asked to come here for this purpose, and that the interest which I take as an artist in the purely artistic side of Greek archæology leads me to give what little help may be gained from my presence here towards the support of this British School at Athens, whose growing success is evidenced by the Report of the Managing Committee, which you have just heard read. It is evident, however, from this Report that the School still stands in need of considerable further assistance, if the work which it is formed to do is to be efficiently carried out, and if it is to be further developed in the direction of usefulness, which its founders and well-wishers intend that it should pursue; namely, that of a school for research in Greek art and archæology, not so much as competing with as co-operating with the schools of other nations now established at Athens, and so liberally endowed by their respective governments.

An important step in this development has been the establishment, through the initiation of Mr. Cecil Smith, to whom we are now, to our great regret, obliged to refer as the late Director of the School, of the Hostel for students. This establishment, which he has had so much at heart, has now been built, and will be ready to receive the students when they go out to Athens next season. Mr. Cecil Smith and the Committee have succeeded by continuous efforts in raising nearly £1,000 towards the £1,200 which was required to complete the building; the £300 necessary for furnishing it and otherwise making it ready against the ensuing winter he hopes to be able to provide from the School funds; but it is evident that the provision for this purpose will hamper the School in some of the objects for which it was instituted, and you will learn with regret that it is hoped to save this money on excavations; my hope would be that some liberal person might be induced to save this cost to the School. Excavations are the very life of archæology, and when we learn that our School at Athens has, in spite of the recent war, carried on its excavations during the winter, with the results that the Director will describe to you in his Report, and that it is the only one of the four schools at Athens that has followed this important part of their work, you will feel, I am sure, that such energy is deserving of the best support that can be given, and that any liberality bestowed in specially providing for the furnishing of the Hostel will not be wasted. It will easily be seen of what advantage the Hostel will be to students going out to Athens, not only by saving them the heavy cost of living in hotels, or the discomfort of lodgings which are not easily to be got, and frequently when found are wretched places, according to English ideas, but in the facilities it will afford by the life in common of the students for intercommunication of ideas and comparison of results. From every point of view, therefore, I venture to say that Mr. Cecil Smith's Hostel is deserving of the assistance which is required to complete it.

The good work which the School is achieving will be seen from the Director's Report. I learn that an excavation in the immediate neighbourhood of Athens has settled a point of topography, the position of the Kynosarges, which has hitherto been doubtful, and which has been decided, as is usual, on the loose literary evidence available, in different ways, according to the views of the learned interpreters. The question may not in itself be of great importance, but it points to the value of excavations under the guidance of scholars. The Report has shown you what is desired in this direction, but excavating is expensive, and without further assistance in money work of this kind must necessarily be limited. It is difficult to resist a hope that at some future time the funds of the School may be in such a flourishing state as to place it in a position to purchase ground in the modern city, where who knows what exquisite works of art may be concealed under gardens and buildings? Such a hope is more perhaps in the nature of a dream; and when we look at the balance-sheet, and see that the annual income from investments amounts to £48 18s. 9d., such a dream seems very far from realization. The Government grant of £500 a year which the School obtained through the liberality of Sir William Harcourt is a most valuable support, and it is sincerely to be hoped that the end of the five years for which it is promised will

not see the termination of the grant. The rest of the income is derived from the annual subscriptions, amounting to over £860; the well-wishers of the School must see to it that this rather precarious source of income not only does not diminish, but grows in amount. As long, however, as the School continues in the excellent course which it has pursued up to now, there is every reason to hope that it will receive public acknowledgment in the form which is most useful to it. Independently of excavations, the highest results are to be hoped for from the facilities which are given to its students to attend the lectures not only of their own, but of the other archaeological schools which flourish in Athens, leading perhaps to the establishment of that university for archæology which it is hoped by the Committee may be created in the near future, and for which Athens, which saw the birth and culmination of Art and Literature, is the appropriate centre. Ladies and gentlemen, I apologize again for the brevity and inadequacy of this address, which is due to the reasons which I explained at the beginning; and I propose the adoption of the Report of the Managing Committee.

The motion was seconded by Professor PERCY GARDNER, who took occasion to dwell upon the importance of excavation to archæology, and spoke warmly of the work done by the School. The Report was unanimously adopted.

The following Resolution was then put from the Chair, supported by Dr. LEAF, and carried unanimously:—

“That the hearty thanks of the meeting be offered to Mr. G. A. MACMILLAN, on his retirement from the office of Honorary Secretary, for his invaluable service, in that capacity, and for his unfailing devotion to the interests of the School.”

Mr. MACMILLAN having acknowledged the vote, the following Resolution, moved by Professor WALDSTEIN and seconded by Mr. H. H. STATHAM, was carried unanimously:—

“That Professor ERNEST GARDNER, Miss JANE HARRISON, Mr. GEORGE MACMILLAN, and Mr. CECIL SMITH be elected members of the Managing Committee; and that Mr. WALTER LEAF be re-elected Treasurer, and Mr. WILLIAM LORING be elected Hon. Secretary of the School for the ensuing session.”

The Director of the School, Mr. CECIL SMITH, read parts of the following Report on the work of the Session.

REPORT OF THE DIRECTOR FOR THE SESSION 1896-7.

It is perhaps superfluous to remark that circumstances have been somewhat adverse to the prospects of the School work during the past session. The political troubles of Greece could not but affect in some measure the efficiency of all the foreign Schools which enjoy Greek hospitality, and although we may fairly claim to have struggled successfully against this difficulty, there is no denying the fact that it has hampered us considerably. But this was only one of our troubles: a still more serious drawback has been caused by illness, which has totally disabled one of our Students and partially incapacitated two others. The loss of Mr.

Bosanquet's services, under circumstances already referred to by the Honorary Secretary, has been a grave misfortune not only for the School, but for me personally, who had relied on a continuance of the material support which his previous experience afforded me during last session. So that, whatever measure of success we have achieved—and I think we may claim a distinct success—it has been rather in the teeth of adverse circumstances. With the unusually large number of Students attached this year to the British School—considerably larger than those of any other School in Athens—we had good reason to expect a season of unusual prosperity and usefulness.

Early in November we arrived at Patras, having been joined on the journey out by Messrs. Bosanquet and Clark. During a short stay here we were fortunate in discovering the statuette of Athena Parthenos, of which an account is given on p. 121 of this volume.*

We were also enabled to study an interesting mosaic recently discovered in the town (see p. 122), of part of which Mr. Clark subsequently made a coloured rubbing.

It is highly probable that a small and inexpensive excavation on the site at Psilalonia would result in the discovery of further fragments of this important figure; on behalf of the School I offered M. Cavvadias to undertake the necessary researches: the offer was declined, M. Cavvadias alleging as his reason that the Greek Government would itself carry out the work. Up to the time when we left Greece, nothing had yet been done, and the statuette so far as I know still remains in the Demarcheion at Patras, subject to the handling of officials who, if not wantonly careless, are at least wholly inexperienced in the proper treatment of delicate works of art. Fortunately the Greek Government have at last been persuaded to have the statuette moulded; and a cast has been presented by M. Cavvadias to the British Museum, and is now exhibited in the Elgin Room.

The Honorary Secretary has already mentioned the names of the Students who formed the School during this season. Most of them joined us before Christmas, and remained until the end of the season. During this time they were occupied in the usual way in studying the antiquities of Athens, in attending the several courses of lectures delivered in connection with the different Schools, and attending the open meetings; in making expeditions to interesting ancient sites; and in library work at the School. Under this last heading I may mention that considerable progress has been made in the compilation of the topographical *Schriftquellen* commenced last year. I had hoped it might have been still further advanced, but it was always understood that this work was intended to supply a general occupation for the leisure spared from private studies. Each Student has had this year an individual subject of study or research on which he has been primarily engaged, and of which the results will eventually be published, either in a separate form, or in the *Journal of Hellenic Studies*, or in the Annual of the School. It is an obviously sensible principle that the excavations of one season should furnish material for the

* By the courtesy of the Secretaries I was permitted to make a preliminary statement on the subject at the opening meeting of the German Institute in Athens.

study of the succeeding season. The publication of the results of last year's excavations in Melos and Athens occupied a good deal of the time of Mr. Mackenzie and myself. Mr. Mackenzie had spent a good part of the summer very usefully in making an archæological survey of the island of Melos; the results of this work form the subject of an interesting paper read at one of the open meetings of the School (see p. 71). The antiquities of the islands are in many instances still comparatively unexplored, and are subject to the caprice, or even the trafficking, of the ignorant peasantry, and it is therefore highly desirable that, before it is too late, everything that can be done should be done to place on record their valuable but steadily disappearing remains of art and history. Mr. Mackenzie is this year making a tour of the other islands of the Cyclades: he has visited Kimolos, Pholegandros, Siphnos, Paros, and Antiparos, and is going on to Naxos, Ios, Sikinos, and Amorgos.

Mr. Bosanquet early in November undertook at the desire of the Committee a journey to Pylos, in order, if possible, to clear up some of the points at issue between Messrs. Grundy and Burrows, and of which the controversy has been carried on in the *J. H. S.* It was in returning from this expedition that Mr. Bosanquet unfortunately contracted the fever which totally disabled him for more than four months, and ended in his being invalided home; the results of his work will appear in a forthcoming number of the Journal referred to.* Miss Hutton, whose stay in Greece lasted from October to March, gave me most valuable assistance in the arrangement and preparation for publication of the pottery which we had discovered during 1896: a specimen of Miss Hutton's skill is the upper part of a vase of the class known as Melian, which has been put together by her from a great many fragments, and will shortly be published: it represents an important addition to a class of painted vases of which very few examples are as yet known. I may here add that the fragments from one of the graves opened in Melos last year on being put together prove to make up a vase of undoubted Melian fabric, but of a type which was hitherto entirely unknown. Miss Hutton's principal work was devoted to the study of the terra-cottas of the Athens Museums: the first-fruits of her work—the publication of some highly interesting reliefs from the Acropolis—will shortly appear in the *Journal*.†

A detailed description of the individual work of each of the twelve Students would occupy too much time; I will therefore merely refer to the epigraphical and topographical work of Mr. Anderson; to the philological studies of Mr. West; Mr. Morrison was occupied in the preparation of materials for a study of polychromy in Greek sculpture; Mr. Edgar, in a study of Greek stelæ in the light they throw upon the history of art; Mr. Crowfoot, in a work on Greek portraiture; and Mr. Rodeck, in a study of the principles of Ionic architecture and of the Byzantine churches of Attica and Mount Athos. Mr. Ambrose Poynter, though unfortunately he was only able to remain a short time in Greece, made good use of his time in the collection of material for the work on mosaics which he has in preparation.

* *J. H. S.* xviii. (1898), p. 155.

† *J. H. S.* xvii. (1897), p. 306.

Among the many Students who made regular use of the Library I may mention Miss Triantaphyllides, an English-speaking Greek lady who attached herself to the work of the School. At my suggestion she has undertaken to collect materials for a study of modern Greek folk-lore: for this highly important study Miss Triantaphyllides has exceptional opportunities, and some results of her work may be seen in this volume (p. 207).

I think it will be agreed that this list shows a fair record of varied and useful work: varied though it is, it really gives no idea of the enormous mass of interesting and important work which lies within the scope of the School, which presses itself on the attention of visitors to Athens, and which should, if the School is properly supported, attract more and more the classical scholars of England to Athens.

Thanks to the generosity of private donors, and to the liberal purchases made by the Committee during the past two seasons, the Library is gradually assuming dimensions more worthy of the British School. In the laborious duty of rearrangement of the books, and of the preparation of the Catalogue, I have had the greatest assistance from Mr. Edgar, who has most kindly performed most of the duties of librarian: the printed catalogue, which is mainly due to him, will be ready for issue in a short time.

Mr. Charles Clark, who came out as School architect for the second year in succession, and who gave us his time from the middle of November until the end of June, was occupied with the preparation of the drawings necessary for the publication of the results of our excavations of last year and this year. Some of the results of this work have already been published, but careful and elaborate as these are, they must be taken as representing only to an infinitesimal degree the labour and care which their preparation has entailed. In addition to this work, there has fallen upon Mr. Clark a large proportion of the extra labour connected with the building of the Hostel; it was scarcely to be expected that a Greek architect and Greek contractors would realise, without some trouble, the requirements of an English hostel; as a matter of fact there is scarcely a detail which has not at one time or another undergone modification or alteration at the hands of Mr. Clark and myself, and we may claim to have personally superintended the placing, I may almost say, of every stone. In some instances details of the architecture and fittings have been designed by Mr. Clark, and in one case by Mr. Rodeck, who during our absence in Melos kindly undertook the personal superintendence of the work. Throughout the whole matter we have had the great advantage of the assistance and advice of Mr. Arthur Hill, who has once more devoted himself with untiring zeal to the interests of the School.

The original site chosen for the Hostel was near the lower wall of the School temenos; for various reasons it was found necessary to alter this to a site higher up the slope, and nearer the present School building; it was then found that the sloping roof originally designed would partially block the view from the American School. After considerable difficulty a compromise was arranged, whereby the roof now consists partly of a low-pitched gable, and partly of a flat, railed-in

space, accessible from below. This *patio*, commanding superb views of the Saronic Gulf and the valley to Pentelicus, will provide an excellent place of retreat for the hot summer evenings, and may be regarded as fully compensating for the somewhat squat appearance caused by the modification of the original design.

The first sod was cut on the first day of the year, and shortly afterwards the foundation-stone was laid by Her Majesty the Queen of the Hellenes, who has continued to show the most gracious interest in the affairs of the School. By the beginning of June, when I left Athens, the construction was almost entirely finished, and there remained only a few details of the interior arrangement which Mr. Clark, who remained in Athens for this purpose, was able to see executed; and shortly afterwards the keys were handed over to Mr. Hill as the representative of the School.

The Hostel as it stands represents two-thirds of the original plan submitted to the Committee; and provision has been made in order that, if the necessity should arise, and funds be forthcoming, the remaining one-third can be added with the least possible cost. The building already erected consists of a basement, ground floor, and first floor, covering an area of rather more than 19 metres by 21 metres. Besides a large common room (which can, if necessary, be used as an additional library) it provides ten bedrooms, two bath-rooms and all the usual offices, a photographic room, and two store-rooms for general purposes. The building is orientated in such a way that full advantage can be taken of the sun in winter and the cool in summer. The waste places of the *temenos* having thus been partially filled, it is to be hoped that, as time goes on, the present School garden may be continued down to and around the Hostel.

The School building has hitherto been lit with oil lamps, a system which in Athens is peculiarly costly and inadequate. The construction of the Hostel gave me the opportunity for opening up the question of lighting our buildings by some less antiquated method. The town of Athens is well supplied with electric light; but unfortunately the circuit is not yet extended to any point near the School; and even if it were, the available plant would not be strong enough for any further extension. Owing to these circumstances, the estimated cost of an electric supply from the city company proved quite prohibitive. I then obtained estimates of the cost of setting up and working a private gas-engine with dynamos capable of providing sufficient electric light for our purpose. In this I had hoped to have the co-operation of the American School; for a comparatively small outlay (which would have soon repaid itself) this might have been accomplished, but, unfortunately, the committee of the American School did not see their way to the necessary expenditure. I was, therefore, obliged to have recourse to the city gas company, and they have, for a very moderate cost, laid on a capital gas supply to every room in our two buildings.

The excavation on the site of Kynosarges, commenced by me in the spring of 1896 with funds provided by two personal friends, was continued in the winter and spring of 1896-7, and brought to a satisfactory conclusion. The ground-

plan of the large building, which is now generally accepted* as that of the historic gymnasium, has been as far as possible recovered, and a mass of new material procured, some of which affords valuable confirmation of the proposed identification of the building.† The close supervision of the excavation was kindly undertaken by all the students in turn, and although this work necessarily absorbed a considerable amount of their time, I think this sacrifice is fully warranted by the experience so gained and the result achieved. The excavation, with plans drawn up by Mr. Clark, will form the subject of a publication in a forthcoming number of the *Hellenic Journal*. A preliminary statement has already been made in an open meeting of the School at Athens.

During the spring the usual open meetings were held, and were well attended by residents of all nationalities in Athens; and I gave a course of ten lectures on the history of vase-painting.

The unfortunate war, which put a stop to so many undertakings, prevented the celebration of the fêtes of the French School and the archæological congress which had been proposed in connection with them for the spring of 1897; several meetings, however, were held of the Committee, on which I had the honour to serve, and discussions took place which may prove to be useful in paving the way for the closer co-ordination of the work of the different foreign schools in Athens. In this connection I may remark that an advance was made in the direction of concerting a plan as regards the various libraries, suggested by me in last year's Report.‡ On April 12th the principal representatives of the different institutions met at the British School to discuss (i.) a unified scheme of catalogues; and (ii.) the systematising of purchases of books. As regards (i.) it was agreed that the forthcoming catalogue of the library of the German School in Rome should be taken as the basis, as being the most complete archæological library in existence, and that copies should be prepared with an initial marked against each book, showing in which library a copy of that book is to be found. As yet this catalogue is not ready for issue, but Dr. Wolters undertook to represent the scheme in Berlin as an additional reason for pressing forward the printing of the Roman catalogue. In case of any considerable delay, the Directors gave an undertaking to have hectograph copies of their catalogues made and one copy placed in each of the libraries.

As regards (ii.) some difficulty was felt as to the selection of the special line to be followed by each library. It was decided that each nationality should endeavour to develop as a principle the class of archæological or classical books published by that nation, and that the more expensive works should be purchased by only one library on a preconcerted plan. For this purpose it was agreed that similar meetings of Directors should in future be regularly held as occasion demands.

It will thus be seen that a principle of co-operation has been established, which may be of great importance in the future on matters even outside the range of the School libraries.

* See *Ath. Mitt.*, 1896, p. 463.

† See the articles by Mr. Rodeck, p. 89, and Mr. Anderson, p. 112, of this volume

‡ See *B. S. A.*, ii. p. 19.

The principal excavation work of the session was, of course, the continuation of the undertaking in Melos, of which a full account is given on pp. 1 foll. of this volume.

In bringing to a close my term of Directorship, I wish to offer sincere thanks to the Committee of the School for the generous measure of confidence they have reposed in me ; to the students of the School, who have one and all done their utmost to make our residence in Athens pleasant and (I hope) useful ; to the Directors and Members of the other Schools, and to the Greek authorities who have always been ready with help and encouragement ; and to the many residents in Athens who have helped to make the recollection of our two years' stay there a *καλὸν κτήμα ἐς αἰεί.*

CECIL SMITH.

INCOME AND EXPENDITURE, 4TH JULY, 1896, TO 3RD JULY, 1897.

	£	s.	d.		£	s.	d.
Subscriptions as per list . . .	869	14	0	Director's salary	500	0	0
„ for 1895-6	20	0	0	Studentship, Mr. Clark (Architect)	150	0	0
Government Grant	500	0	0	Mr. Crowfoot	50	0	0
Interest on Investment	58	0	0	Mr. Mackenzie	50	0	0
„ Deposit	8	6	4	House maintenance	63	17	0
				Printing and postage	24	10	3
				Publication of School Annual . . .	158	2	8
				Excavations at Melos	130	13	0
				Sundries	15	19	9
				Balance	312	17	8
	<u>£1,456</u>	<u>0</u>	<u>4</u>		<u>£1,456</u>	<u>0</u>	<u>4</u>

BUILDING FUND.

	£	s.	d.		£	s.	d.
Donations, as per list	1,074	18	6	Paid Builders	1,065	0	0
				Balance	9	18	6
	<u>£1,074</u>	<u>18</u>	<u>6</u>		<u>£1,074</u>	<u>18</u>	<u>6</u>

BYZANTINE FUND.

	£	s.	d.		£	s.	d.
Balance from last account	118	9	5	Insurance	0	15	0
				Balance	117	14	5
	<u>£118</u>	<u>9</u>	<u>5</u>		<u>£118</u>	<u>9</u>	<u>5</u>

CAPITAL ACCOUNT.

	£	s.	d.		£	s.	d.
Balance from last account	2,457	14	3	Library	117	14	3
Donations, General, as per list	23	12	0	Balance down	2,676	9	8
Balance of Income	312	17	8				
	<u>£2,794</u>	<u>3</u>	<u>11</u>				
					<u>£2,794</u>	<u>3</u>	<u>11</u>

BALANCE ACCOUNT.

	£	s.	d.		£	s.	d.
General Balance	2,676	9	8	India 3% Stock, at par	2,000	0	0
Building Fund Balance	9	18	6	Deposit Account	500	0	0
Byzantine Fund ,,	117	14	5	Balance at Bank	304	2	7
	<u>£2,804</u>	<u>2</u>	<u>7</u>				
					<u>£2,804</u>	<u>2</u>	<u>7</u>

Examined and found correct, 17th Nov., 1897.

LINGEN.
F. POLLOCK.

GENERAL DONATIONS—1896-7

	£	s.	d.
Cates, A.	10	10	0
Johnston, C. E.	10	0	0
Kennedy, Sir W. R.	2	2	0
Elliot, F. (Sofia)	1	0	0
	<u>£23</u>	<u>12</u>	<u>0</u>

ANNUAL SUBSCRIPTIONS—1896-7.

	£	s.	d.
H.R.H. THE PRINCE OF WALES	25	0	0
The University of Oxford	100	0	0
The University of Cambridge	100	0	0
McGill University, Montreal	5	5	0
The Hellenic Society	100	0	0
The Society of Antiquaries	5	5	0
Brasenose College, Oxford	5	0	0
Christ Church, Oxford	20	0	0
Corpus Christi College, Oxford	5	0	0
King's College, Cambridge	10	0	0
Magdalen College, Oxford	10	0	0
	£	s.	d.
Agnew, Sir W.	2	2	0
Allbutt, Professor T. C.	1	1	0
Austen Leigh, E. C.	1	1	0
Awdry, H.	1	1	0
Bailey, J. C.	5	0	0
Barlow, Dr. T.	1	1	0
Bond, E. A., C.B.	1	1	0
Brinton, H.	1	1	0
Brooke, Rev. Stopford	1	1	0
Butcher, Prof.	2	2	0
Butler, Dr.	2	0	0
Buxton, H. E.	1	0	0
Bury, Prof. J. B.	1	1	0
Campbell, Prof. L.	1	1	0
Carlisle, Miss	1	1	0
Carr, Rev. A.	1	1	0
Chawner, W.	2	2	0
Colchester, Lord	5	0	0
Cole, A. C.	2	2	0
Cust, Miss A. M.	1	1	0
Davey, Lord	5	0	0
Davidson, H. O. D.	1	1	0
Donaldson, Rev. S. A.	1	1	0
Earl, A. G.	1	1	0
Egerton of Tatton, Lord	10	10	0
Elliot, Rev. F.	1	1	0
Fumoropoulos, A.	1	1	0
Evans, A. J.	10	0	0
Evans, Sir J.	5	0	0
Ewart, Miss.	5	0	0
Flower, Mrs. Wickham	1	1	0
	£	s.	d.
Fort, J. A.	1	0	0
Fowler, W. W.	1	1	0
Freshfield, D. W.	10	0	0
Gardner, Prof. Percy	2	2	0
Haigh, A. E.	1	0	0
Hawes, Miss	1	1	0
Hay, C. A.	5	5	0
Heberden, C. B.	2	2	0
Hereford, Bishop of	1	1	0
Herschell, Lord	5	0	0
Hill, G. F.	1	1	0
Hillingdon, Lord	10	0	0
Hogarth, D. G.	2	0	0
Howard de Walden, Lady	20	0	0
Jones, H. Stuart	1	1	0
L. J. E.	1	0	0
Lawson, Sir E.	5	0	0
Leaf, C. J.	5	5	0
Leaf, Mrs. C. J.	5	5	0
Leaf, Walter	20	0	0
Lewis, Mrs. A. S.	2	2	0
Lingen, Lord	2	2	0
Loring, W.	5	0	0
Loring, Miss	1	1	0
Lloyd, Miss	1	1	0
Lynch, H. F.	2	2	0
Macan, R. W.	1	1	0
Macmillan, G. A.	10	10	0
Macmillan & Co.	20	0	0
Carried forward	606	9	0

LIST OF SUBSCRIBERS.

NOTE. Under No. V. of the Rules and Regulations, "the following shall be considered as Subscribers to the School :—

- (1) Donors of £10 and upwards.
- (2) Annual Subscribers of £1 and upwards during the period of their subscription.
- (3) Corporate bodies subscribing £50 at one time, or £5 annually."

In making out the following list, donations of less than £10 have been regarded as aggregate annual subscriptions of £1, and are spread over a corresponding number of years.

The Treasurer would be glad to be informed of any changes of address or errors in this list.

H.R.H. THE PRINCE OF WALES, K.G., &c., &c., Marlborough House, S.W.

THE UNIVERSITY OF OXFORD.

THE UNIVERSITY OF CAMBRIDGE.

MCGILL UNIVERSITY, Montreal.

THE SOCIETY FOR THE PROMOTION OF HELLENIC STUDIES, 22, Albemarle Street, W.

THE SOCIETY OF ANTIQUARIES, Burlington House, Piccadilly, W.

BRASENOSE COLLEGE, Oxford.

CHRIST CHURCH, Oxford.

CORPUS CHRISTI COLLEGE, Oxford.

KING'S COLLEGE, Cambridge.

MAGDALEN COLLEGE, Oxford.

THE GREEK PLAY COMMITTEE (per J. W. Clark, Esq., Scroop House), Cambridge.

THE HON. COMPANY OF CLOTHWORKERS, Mincing Lane, E.C.

Abbott, Evelyn, Esq., Balliol College, Oxford.

Abercrombie, J., Esq., M.D., 23, Upper Wimpole Street, W.

Adam, J., Esq., Emmanuel College, Cambridge.

Agnew, Sir William, Bart., 11, Great Stanhope Street, Park Lane.

Alexander, W. C., Esq., 24, Lombard Street, E.C.

Allbutt, Prof. T. Clifford, F.R.S., St. Rhadegund's, Cambridge.

Austen-Leigh, E. C., Esq., Eton College.

Awdry, H., Esq., Wellington College, Wokingham.

Bailey, J. C., Esq., 2, Tanfield Court, The Temple, E.C.

Baker, The Rev. Sir Talbot, Bart., Ranston, Blandford.

Balfour, The Right Hon. G. W., M.P., 24, Addison Road, W.

Barlow, T., Esq., M.D., 10, Wimpole Street, W.

Bather, Rev. A. G., The College, Winchester.

Blomfield, Sir A. W., A.R.A., 28, Montagu Square, W.

Bosanquet, C. B. P., Esq., Rock Hall, Alnwick.

Bosanquet, R. C., Esq., 11, Upper Porchester Street, W.

Brassey, The Right Hon. Lord, 4, Great George Street, W.

Brinton, Hubert, Esq., Eton College.

Brooke, Miss E., Northgate House, Honley, near Huddersfield.

Brooke, The Rev. Stopford, 1, Manchester Square, W.

- Brooks, E. W., Esq., 28, Great Ormond Street, W.
 Burdett-Coutts, The Baroness, Holly Lodge, Hampstead.
 Bury, Prof. J. B., Trinity College, Dublin.
 Butcher, Professor, The University, Edinburgh.
 Bute, The Most Hon. Marquis of, K.T., St. John's Lodge, Regent's Park, N.W.
 Butler, The Very Rev. Dr., Master of Trinity College, Cambridge.
 Buxton, A. F., Esq., 50, Cornhill, E.C.
 Buxton, F. W., Esq., 50, Cornhill, E.C.
 Buxton, H. E., Esq., Fritton, Great Yarmouth.
 Bywater, Mrs., 93, Onslow Square, S.W.
 Bywater, Prof. Ingram, Christchurch, Oxford.
- Campbell, The Rev. Prof. L., 33, Campden House Chambers, W.
 Carlisle, Miss Helen, High Lawn, Bowdon, Cheshire.
 Carr, The Rev. A., Addington Vicarage, Croydon.
 Cates, Arthur, Esq., 12, York Terrace, Regent's Park, N.W.
 Chamberlain, The Right Hon. J., M.P., 40, Prince's Gardens, S.W.
 Chamberlain, J. Austen, Esq., M.P., 40, Prince's Gardens, S.W.
 Chambers, Colonel O., E. I. United Service Club, 16, St. James's Square, W.
 Chawner, W., Esq., Master of Emmanuel College, Cambridge.
 Colchester, The Right Hon. Lord, 25, Portman Square, W.
 Cole, A. C., Esq., 64, Portland Place, W.
 Colvin, Sidney, Esq., British Museum, W.C.
 Cook, Sir F., Bart., 22, St. Paul's Churchyard, E.C.
 Corbett, V., Esq., British Legation, Athens.
 Cowper, The Right Hon. Earl, Panshanger, Hertford.
 Cruddas, Miss, Haughton Castle, Humshaugh-on-Tyne, Northumberland.
 Cust, Lionel, Esq., 9, Bryanston Square, W.
 Cust, Miss A. M., 63, Elm Park Gardens, S.W.
- Dabis, Miss, Royal Holloway College, Egham.
 Dakyns, H. G., Esq., Higher Coombe, Haslemere.
 Darwin, Prof. G. H., F.R.S., Cambridge.
 Davey, The Right Hon. Lord, 86, Brook Street, W.
 Davidson, H. O. D., Esq., Harrow.
 Davies, The Rev. G. S., Charterhouse, Godalming.
 Deacon, W. S., Esq., Pointers, Cobham, Surrey.
 Dilke, The Right Hon. Sir C. W., Bart., M.P., 76, Sloane Street, S.W.
 Donaldson, The Rev. S. A., Eton College.
 Durham, The Right Hon. The Earl of, 4, Cavendish Square, W.
 Durnford, Walter, Esq., Eton College.
- Earl, A. G., Esq., Ferox Hall, Tonbridge.
 Egerton, Sir E. H., K.C.B., H.B.M. Minister, British Legation, Athens.
- Egerton, The Right Hon. Earl, 7, St. James's Square, S.W.
 Elliot, Francis E. H., Esq., British Agency, Sofia.
 Elliott, The Rev. F. R., British Legation, Athens.
 Emerson, W., Esq., 8, The Sanctuary, Westminster, S.W.
 Eumorfopoulo, N., Esq., 1, Kensington Park Gardens, W.
 Evans, Arthur J., Esq., Ashmolean Museum, Oxford.
 Evans, Sir John, K.C.B., D.C.L., F.R.S., Nash Mills, Hemel Hempstead.
 Ewart, Miss, 68, Albert Hall Mansions, S.W.
- Farrer, Sir W. J., Sandhurst Lodge, Wellington College Station, Berks.
 Fitzmaurice, Lady E., 2, Green Street, W.
 Fitz-Patrick, Thos., Esq., M.D., 30, Sussex Gardens, W.
 Fletcher, H. M., Esq., 9, Stanhope Street, Hyde Park, W.
 Fletcher, John M., Esq., 9, Stanhope Street, Hyde Park, W.
 Flower, Mrs. Wickham, Old Swan House, Chelsea Embankment, S.W.
 Fort, J. A., Esq., 27, Kingsgate Street, Winchester.
 Fowler, W. W., Esq., Lincoln College, Oxford.
 Fox, M. D., Esq., 1, Airlie Gardens, W.
 Fox, M. D., Esq., Bank Buildings, E.C.
 Fry, The Right Hon. Sir E., LL.D., F.R.S., Fairfield House, Fairland, near Bristol.
 Furley, J. S., Esq., Chernocke House, Winchester.
- Gardner, J. T. Agg., Esq., Carlton Club, Pall Mall, S.W.
 Gardner, Prof. Percy, Litt.D., 12, Canterbury Road, Oxford.
 George, Ernest, Esq., 18, Maddox Street, W.
 Gibson, John, Esq., 11, Westbourne Square, W.
 Gilliat, Rev. E., Harrow.
 Gow, James, Esq., Litt.D., High School, Nottingham.
 Graham, Alex., Esq., Carlton Chambers, 4, Regent Street, S.W.
 Graham, E., Esq., Harrow.
 Gurney, Miss A., 69, Ennismore Gardens, S.W.
 Gurney, Miss M., 69, Ennismore Gardens, S.W.
- Haigh, A. E., Esq., 2, Crick Road, Oxford.
 Hallam, G. H., Esq., The Park, Harrow.
 Hardie, Prof. W. R., 4, Chalmers Crescent, Edinburgh.
 Hardy, Mrs., 1, Cadogan Square, S.W.
 Harris, A., Esq., Lunefield, Kirkby Lonsdale.
 Harrison, Miss, LL.D., 13, Barkston Mansions, Earl's Court, S.W.
 Hawes, Miss, 89, Oxford Terrace, W.
 Haworth, Jesse, Esq., Woodside, Bowdon.
 Hay, Charles Anderson, Esq., 127, Harley Street W.

- Headlam, Walter, Esq., King's College, Cambridge.
- Heberden, C. B., Esq., Principal of Brasenose College, Oxford.
- Herbert, The Hon. Auberon, The Old House, Ringwood.
- Hereford, The Right Rev. The Bishop of, The Palace, Hereford.
- Herschell, The Right Hon. Lord, 46, Grosvenor Gardens, W.
- Hill, G. F., Esq., British Museum, W.C.
- Hogarth, D. G., Esq., Magdalen College, Oxford.
- Hornby, The Rev. Dr., Provost of Eton College.
- Howard de Walden, The Dowager Lady, 35, Portland Place, W.
- Howson, E. W., Esq., Harrow.
- Ingelow, Benjamin, Esq., Carlton Chambers, 4, Regent Street, S.W.
- Ionides, Const., Esq., 23, Second Avenue, West Brighton.
- Irving, Sir Henry, Lyceum Theatre, W.C.
- Iveagh, The Right Hon. Lord, 5, Grosvenor Place, S.W.
- James, The Rev. H. A., D.D., School House, Rugby.
- Jebb, Prof. R. C., Litt.D., M.P., Springfield, Cambridge.
- Jenner, Miss, 39, Addison Road, W.
- Johnston, C. E., Esq., 23, Queen's Gate Terrace, S.W.
- Jones, H. Stuart, Esq., Trinity College, Oxford.
- Kennedy, The Hon. Sir W. R., 94, Westbourne Terrace, W.
- Keser, J., Esq., M.D., 11, Harley Street, W.
- King, Miss Catherine, Oxton, Birkenhead.
- Knowles, James, Esq., Queen Anne's Lodge, St. James's Park, S.W.
- L. J. E., c/o the Rev. Brooke Lambert, Greenwich.
- Lascelles, B. P., Esq., Harrow.
- Lawrence, Edwin, Esq., M.P., 13, Carlton House Terrace, S.W.
- Lawrence, The Misses, 18, Whitehall Place, S.W.
- Lawson, Sir E., Bart., *Daily Telegraph*, Fleet Street, E.C.
- Leaf, Mrs. C. J., Beechwood, Tunbridge Wells.
- Leaf, Walter, Esq., Litt.D., 6, Sussex Place, Regent's Park, N.W.
- Lecky, Mrs., 38, Onslow Gardens, S.W.
- Lewis, Mrs. S. S., Castle-brae, Cambridge.
- Lewis, T. Hayter, Esq., 12, Kensington Gardens Square, W.
- Lindley, Miss Julia, 74, Shooter's Hill Road, Blackheath, S.E.
- Lindley, W., Esq., M.Inst.C.E., 10, Kidbrook Terrace, Blackheath, S.E.
- Lingen, The Right Hon. Lord, K.C.B., 13, Wetherby Gardens, S.W.
- Lister, The Right Hon. Lord, P.R.S., 12, Park Crescent, Portland Place, W.
- Llangattock, The Right Hon. Lord, The Hendre, Monmouth.
- Lloyd, Miss A. M., Caythorpe Hall, Grantham.
- Loch, The Right Hon. Lord, G.C.B., G.C.M.G., 44, Elm Park Gardens, S.W.
- Loring, Miss, 14, Montagu Street, Portman Square, W.
- Loring, W., Esq., 2, Hare Court, Temple, E.C.
- Lowry, C., Esq., Eton College.
- Lubbock, The Right Hon. Sir John, Bart., M.P., F.R.S., High Elms, Farnborough R.S.O.
- Lucas, Sir Thomas, Bart., 12a, Kensington Palace Gardens, W.
- Lynch, H. F., Esq., 33, Pont Street, S.W.
- Macan, R. W., Esq., University College, Oxford.
- MacLehose, James J., Esq., 61, St. Vincent Street, Glasgow.
- Macmillan, G. A., Esq., 19, Earl's Terrace, Kensington, W.
- Macmillan, Messrs., & Co., Ltd., St. Martin's Street, W.C.
- Macnaghten, Hugh, Esq., Eton College.
- Markby, A., Esq., Copse Hill, Wimbledon.
- Marindin, G. E., Esq., Broomfields, Farnham, Surrey.
- Mitchell, C. W., Esq., 195, Queen's Gate, S.W.
- Mocatta, F. D., Esq., 9, Connaught Place, Edgware Road, W.
- Mond, Ludwig, Esq., F.R.S., 20, Avenue Road, Regent's Park, N.W.
- Monk, Miss, 4, Cadogan Square, S.W.
- Monro, D. B., Esq., Provost of Oriel College, Oxford.
- Monson, His Excellency the Right Hon. Sir E., G.C.B., G.C.M.G., British Embassy, Paris.
- Montagu, Sir S., Bart., M.P., 12, Kensington Palace Gardens, W.
- Montefiore, C. G., Esq., 12, Portman Square, W.
- Morley, The Right Hon. The Earl of, 31, Prince's Gardens, S.W.
- Motley, Howard, Esq., 47, Grosvenor Street, W.
- Morley, The Right Hon. John, M.P., 57, Elm Park Gardens, S.W.
- Morshead, E. D. A., Esq., Grafton Villa, Winchester.
- Moss, J. C., Esq., Harrow.
- Mumm, A. L., Esq., 4, Hyde Park Street, W.
- Murray, Messrs. J. & H., 50, Albemarle Street, W.
- Murray, Prof. G. G. A., The University, Glasgow.
- Myers, Ernest, Esq., Brackenside, Chislehurst.
- Mylne, Mrs., 83, Gloucester Terrace, Hyde Park, W.
- Neil, R. A., Esq., Pembroke College, Cambridge.
- Newman, W. L., Esq., 1, Pittville Lawn, Cheltenham.
- Oswald, J. W. Gordon, Esq. (of Aigas), Beaulieu, Inverness-shire, N.B.
- Oules, W. W., Esq., R.A., 12, Bryanston Square, W.

- Paton, W. R., Esq., British Post Office, Smyrna.
 Pears, E., Esq., 2, Rue de la Banque, Constantinople.
 Pelham, Prof. H. F., President of Trinity College, Oxford.
 Pelham, The Hon. Mrs. Arthur, 16, Duke Street, Manchester Square.
 Penrose, F. C., Esq., F.R.S., D.C.L., Litt.D., Coleby-field, Wimbledon.
 Perry, W. C., Esq., 7a, Manchester Square, W.
 Pitt-Rivers, Lieutenant-General, Rushmore, Salisbury.
 Plumbe, Rowland, Esq., 13, Fitzroy Square, W.
 Pollock, Sir F., Bart., 48, Great Cumberland Place, W.
 Poynter, Sir E. J., P.R.A., 28, Albert Gate, S.W.
 Radford, Dr., Sidmouth.
 Ralli, Mrs. S., 32, Park Lane, W.
 Ralli, P., Esq., 17, Belgrave Square, W.
 Ralli, Stephen, Esq., 25, Finsbury Circus, E.C.
 Rathbone, Mrs., Woodgate, Sutton-Coldfield.
 Rawlinson, W. G., Esq., 134, Cheapside, E.C.
 Reid, J. S., Esq., Litt.D., Caius College, Cambridge.
 Rendall, G. H., Esq., Litt.D., Charterhouse, Godalming.
 Richards, H. P., Esq., Wadham College, Oxford.
 Richmond, The Bishop of, the Rectory, Stanhope, R.S.O. Co. Durham.
 Robb, Mrs., 46, Rutland Gate, S.W.
 Roberts, Prof. W. Rhys, University College, Bangor.
 Robertson, Charles, Esq., Redfern, Colinton Road, Edinburgh.
 Romanes, Mrs., 18, Cornwall Terrace, Regent's Park, N.W.
 Rosebery, The Right Hon. the Earl of, The Durdans, Epsom.
 Rothschild, The Right Hon. Lord, 148, Piccadilly, W.
 Rothschild, Baron F. de, 143, Piccadilly, W.
 Rothschild, Messrs. N. M. and Sons, New Court, E.C.
 Rothschild, The Hon. Walter, 148, Piccadilly, W.
 Rumbold, His Excellency Sir Horace, Bart., G.C.B., British Embassy, Vienna.
 Salisbury, The Most Hon. the Marquis of, K.G., Arlington Street, W.
 Sandys, J. E., Esq., Litt.D., St. John's College, Cambridge.
 Sandwith, T. B., Esq., Manor House, Hove, Brighton.
 Saumarez, The Right Hon. Lord de, Shrubland Park, Coddensham, Suffolk.
 Scott, C. P., Esq., The Firs, Fallowfield, Manchester.
 Seaman, Owen, Esq., Tower House, Putney, S.W.
 Searle, G. von U., Esq., 30, Edith Road, W. Kensington.
 Sharkey, J. A., Esq., Christ's College, Cambridge.
 Sidgwick, Prof. H., Litt.D., Newnham College, Cambridge.
 Smith, Arthur H., Esq., British Museum, W.C.
 Smith, Cecil H., Esq., LL.D., British Museum, W.C.
 Smith, Mrs. C. H., 18, Earl's Terrace, Kensington, W.
 Smith, J. G., Esq., 4, Wilton Street, Grosvenor Place, S.W.
 Smith, R. A. H. Bickford, Esq., 45, North Bailey, Darlington.
 Smith, Prof. T. Roger, 7, Gordon Street, Gordon Square, W.C.
 Southwell, The Right Rev. the Bishop of, Thurgarton Priory, Notts.
 Spiers, R. Phené, Esq., Carlton Chambers, 12, Regent Street, S.W.
 Spring-Rice, S. E., Esq., C.B., Treasury, Whitehall, S.W.
 Stannus, Hugh, Esq., 61, Larkhall Rise, Clapham, S.W.
 Stanton, C. H., Esq., Field Place, Stroud.
 Stapleton, Mrs. E., 46, Montagu Square, W.
 Steinkopff, E., Esq., 47, Berkeley Square, W.
 Stephens, Mrs. Sanders, Stedcombe Manor, Axmouth.
 Stevenson, Miss E. C., 13, Randolph Crescent, Edinburgh.
 Sullivan, John, Esq., Reform Club, Pall Mall, S.W.
 Swanwick, Miss A., 23, Cumberland Terrace, Regent's Park, N.W.
 Tadema, L. Alma, Esq., R.A., 17, Grove End Road, N.W.
 Tancock, The Rev. C. C., Rossall School, Fleetwood.
 Taylor, The Rev. Dr., Master of St. John's College, Cambridge.
 Taylor, J. E., Esq., 20, Kensington Palace Gardens, W.
 Teale, J. Pridgin, Esq., F.R.S., 38, Cookridge Street, Leeds.
 Thompson, Sir E. M., K.C.B., British Museum, W.C.
 Thompson, Sir Henry, 35, Wimpole Street, W.
 Thompson, H. Y., Esq., 26A, Bryanston Square, W.
 Thursfield, J. R., Esq., Fryth, Great Berkhamstead.
 Tozer, The Rev. H. F., 18, Norham Gardens, Oxford.
 Tuckett, F. F., Esq., Frenchay, Bristol.
 Vardy, The Rev. A. R., King Edward's School, Birmingham.
 Vaughan, H., Esq., 28, Cumberland Terrace, Regent's Park, N.W.
 Vaughan, E. L., Esq., Eton College.
 Verrall, A. W., Esq., Litt.D., Selwyn Gardens, Cambridge.

- Vickers, The Rev. W. V., Knowle Grange, Sidmouth.
- Waldstein, Prof. Charles, Litt.D., King's College, Cambridge.
- Wandsworth, The Right Hon. Lord, 10, Great Stanhope Street, W.
- Wantage, The Lady, 2, Carlton Gardens, S.W.
- Warren, T. H., Esq., President of Magdalen College, Oxford.
- Warr, Prof. G. C., King's College, Strand, W.C.
- Warre, The Rev. E., D.D., Eton College, Windsor.
- Waterhouse, Mrs. E., 13, Hyde Park Street, W.
- Watson, Mrs., 2, Clifton Gardens, W.
- Weber, Dr. H., 10, Grosvenor Street, W.
- Wedgwood, G., Esq., Idle Rocks, Stone, Staff.
- Welldon, Rev. J. E. C., Harrow.
- Wells, J., Esq., Wadham College, Oxford.
- West, H. H., Esq., c/o R. W. West, Esq., Casa Bianca, Alassio, N. Italy.
- Wernher, Julius, Esq., 38A, Porchester Terrace, W.
- Westlake, Mrs., 3, Chelsea Embankment, S.W.
- Whateley, A. P., Esq., 4, Southwick Crescent, W.
- Wickham, The Very Rev. E. C., The Deanery, Lincoln.
- Wilson, R. D., Esq., 38, Upper Brook Street, W.
- Wimborne, The Right Hon. Lord, 22, Arlington Street, S.W.
- Winkworth, Mrs., Holly Lodge, Campden Hill, W.
- Wood, The Rev. Dr., The School, Tonbridge.
- Woodhouse, W. J., Esq., 1, Garfield Terrace, Garth Road, Bangor.
- Wroth, Warwick, Esq., British Museum, W.C.
- Yates, Rev. S. A. Thompson, 43, Phillimore Gardens, W.
- Yorke, V. W., Esq., 2, Chesham Street, S.W.
- Yule, Miss A., Chateau Mallet, St. Etienne au Mont, Pas de Calais, France.

DIRECTORS OF THE SCHOOL.

1886—1897.

F. C. PENROSE, F.R.S., 1886—1887.

ERNEST A. GARDNER, M.A., 1887—1895.

CECIL H. SMITH, LL.D., 1895—1897.

LIST OF STUDENTS.

1886—1897.

- | | |
|----------------------|--|
| Ernest A. Gardner, | Formerly Fellow of Gonville and Caius College, Cambridge, and Craven University Student. Admitted 1886—87, Director of the School, 1887—1895. Yates Professor of Archæology at University College, London. |
| David G. Hogarth, | Fellow and formerly Tutor of Magdalen College, Oxford, and Craven University Fellow. Admitted 1886—87. Re-admitted (for work in Cyprus) 1887—88. |
| Rupert Clarke, | Exeter College, Oxford. Admitted 1886—87. |
| F. H. H. Guillemard, | Gonville and Caius College, Cambridge. First University Reader in Geography. Admitted (for work in Cyprus) 1887—88. |
| Montague R. James, | Fellow of King's College, Cambridge; Director of the Fitzwilliam Museum. Admitted (for work in Cyprus) 1887—88, with grant of £100 from the University. |
| R. Elsey Smith, | Appointed to Studentship by Royal Institute of British Architects. Architect to excavations at Paphos, in Cyprus, 1887—88. |
| Robert Weir Schultz, | Admitted as Travelling Student and Gold Medallist of the Royal Academy, 1887—88. Re-admitted 1888—89, 1889—90. Worked on Greek mouldings and on Byzantine architecture. Made the architectural report on the excavations at Megalopolis. |
| Sidney H. Barnsley, | Admitted as Student of the Royal Academy, 1887—88. Re-admitted 1889—90, 1890—91. Worked on Greek mouldings and Byzantine architecture. |
| J. A. R. Munro, | Fellow of Lincoln College, Oxford. Admitted (for work in Cyprus) 1888—89. Re-admitted (for same purpose) 1889—90. |
| H. Arnold Tubbs, | Pembroke College, Oxford; Craven University Fellow. Now Professor of Classics in the University of Auckland. Admitted (for work in Cyprus) 1888—89. Re-admitted (for same purpose) 1889—90. |

- James G. Frazer, Fellow of Trinity College, Cambridge. Admitted 1889—90, with grant of £100 from the University of Cambridge to collect material for commentary on Pausanias.
- William Loring, Examiner in the Education Department and late Fellow of King's College, Cambridge. Appointed to Cambridge Studentship given by the Managing Committee, 1889—90. Re-admitted as Craven University Student, 1890—91, 1891—92, and 1892—93. Assisted in excavations at Megalopolis, and worked at Peloponnesian topography.
- W. J. Woodhouse, Queen's College, Oxford. Appointed to Oxford Studentship given by the Managing Committee, 1889—90. Re-admitted as Craven University Fellow, 1891—92 and 1892—93. Assisted in excavations at Megalopolis, and worked at topography, especially that of *Ætolia*.
- G. C. Richards, Lecturer at Oriel College, Oxford; formerly Fellow of Hertford College; and late Professor of Greek at University College, Cardiff. Admitted as Craven University Fellow, 1889—90. Re-admitted 1890—91. Assisted in excavations at Megalopolis, and worked in Athenian Museums.
- O. H. Parry, Magdalen College, Oxford. Admitted 1889—90. Worked in Athenian Museums.
- J. R. Stainer, Magdalen College, Oxford. Admitted 1889—90. Worked in Athenian Museums.
- R. A. H. Bickford-Smith, Trinity College, Cambridge. Admitted 1889—90.
- A. G. Bather, Fellow of King's College, Cambridge, and Assistant Master at Winchester College. Admitted 1889—90. Re-admitted 1891—92, on appointment to the Cambridge Studentship given by the Managing Committee; 1892—93 as Prendergast Greek Student; and again, 1893—94, as Cambridge Student. Studied and arranged bronze fragments in the Acropolis Museum, and also assisted in excavations at Megalopolis, Kyparissia, and Abae.
- E. E. Sikes, Fellow and Lecturer of St. John's College, Cambridge. Appointed to Cambridge Studentship given by the Managing Committee out of the Newton Testimonial Fund, 1890—91. Worked in Athenian Museums.
- J. G. Milne, Corpus Christi College, Oxford. Examiner in the Education Department. Appointed to Oxford Studentship given by the Managing Committee out of the Newton Testimonial Fund, 1890—91. Assisted in excavations at Megalopolis.
- H. Stuart Jones, Fellow of Trinity College, Oxford. Admitted as Craven University Fellow, 1890—91. Re-admitted 1892—93. Worked, chiefly on Greek vases, in Athenian Museums.
- Miss Eugénie Sellers, Admitted 1890—91. Worked in Athenian Museums. Translated and edited (1895) Furtwängler's "*Meisterwerke der Griechischen Plastik*."
- F. B. Baker, Christ's College, Cambridge. Assistant Master at Malvern College. Admitted 1891—92, with grant from the Craven Fund at Cambridge. Studied coins in the Museum at Athens.
- C. C. Inge, Magdalen College, Oxford. Appointed 1891—92 to the Oxford Studentship given by the Managing Committee. Assisted in the excavations at Megalopolis.

- E. F. Benson, King's College, Cambridge. Admitted 1891—92, with grant of £100 from the Wort's Fund at Cambridge; 1892—93 on appointment to the Cambridge Studentship given by the Managing Committee; 1893—94 as Craven Student; and 1894—95 as Prendergast Student. Assisted in excavations at Megalopolis and Aegosthena, worked at the plan of the Asclepieion, and took part in the excavations of the Egypt Exploration Fund at Alexandria.
- J. G. Smith, Magdalen College, Oxford. Admitted 1891—92. Re-admitted 1895—96. Assisted in collection of topographical passages.
- V. W. Yorke, Fellow of King's College, Cambridge. Admitted 1892—93, re-admitted 1893—94. Worked at the Niké bastion, and assisted in excavations at Kyparissia and Abae.
- J. L. Myres, Student of Christ Church, and late Fellow of Magdalen College, Oxford. Admitted 1892—93. Re-admitted 1893—94, and 1894—95 as Craven Fellow. Worked in Athenian Museums, excavated tumuli near Kará, and travelled in Asia Minor, Cyprus, and Crete. Compiled a catalogue of the Cyprus Museum.
- R. J. G. Mayor, Fellow of King's College, Cambridge, and Examiner in the Education Department. Admitted 1892—93. Worked in Athenian Museums, and assisted in excavations at Aegosthena.
- R. Carr Bosanquet, Trinity College, Cambridge. Admitted 1892—93. Re-admitted as Craven University Student 1894—95, 1895—96, and 1896—97. Worked in Athenian Museums, and assisted in excavations at Aegosthena, Athens, and Melos.
- J. M. Cheetham, Christ Church, Oxford. Admitted on appointment to the Oxford Studentship, given by the Managing Committee, 1892—93, but after a month's residence was obliged, for private reasons, to resign the studentship and return to England.
- E. R. Bevan, New College, Oxford. Admitted 1893—94. Worked in Athenian Museums. Re-admitted 1894—95, and took part in the excavations of the Egypt Exploration Fund at Alexandria.
- A. F. Findlay, Sent out from Aberdeen by the United Presbyterian Church of Scotland. Admitted 1894—95. Worked at *N.T.* criticism and antiquities, and Modern Greek; attended the University; made a special study of the question of St. Paul and the Areopagus.
- T. Duncan, Sent out from Aberdeen by the Church of Scotland. Admitted 1894—95. Worked at Modern Greek and Egyptian antiquities. Afterwards joined Prof. Flinders Petrie in Egypt, and thence proceeded to Palestine.
- J. E. Brooks, St. Peter's College, Cambridge. Admitted 1894—95. Re-admitted as associate 1896—97. Worked at antiquities and Modern Greek.
- H. Awdry, New College, Oxford. Assistant Master at Wellington College. Admitted 1894—95. Studied antiquities with a view to school work; and made special studies of military topography.
- Duncan Mackenzie, Of the University of Edinburgh, where he formerly held a

- Travelling Studentship ; Graduate of the University of Vienna. Admitted 1895-96. Re-admitted 1896-97. Assisted in the excavations in Athens and Melos, and worked in Athenian Museums and at the collection of topographical passages.
- Archibald Paterson, Of the University of Edinburgh. Admitted 1895—96. Worked at Christian antiquities and attended the University.
- Charles R. R. Clark, Appointed (1895-96), and re-appointed 1896—97 by the Managing Committee to an Architectural Studentship, in order to take part in all excavations conducted by the School. Prepared plans and drawings of the excavations in Athens and Melos, and assisted in supervising the building of the Hostel.
- C. C. Edgar, Oriel College, Oxford. Admitted 1895—96, and re-admitted 1896—97 as Craven University Fellow. Worked at Greek sculpture, and assisted in the excavations at Athens and Melos. Assisted in the reorganization of the Library, and the preparation of the Library Catalogue, and in the collection of topographical passages.
- F. R. Earp, Fellow of King's College, Cambridge. Admitted 1896—97. Studied Greek Painting at Pompeii and Naples ; was prevented by ill-health from proceeding to Athens.
- F. A. C. Morrison, Jesus College, Cambridge. Admitted (as Prendergast Greek Student) 1896—97. Worked in Athenian Museums.
- H. H. West, Trinity College, Cambridge. Admitted 1896—97. Worked at collection of topographical passages, and assisted in excavations at Athens and Melos.
- Miss C. A. Hutton, Of Girton College, Cambridge. Admitted 1896—97. Worked (principally at terra-cottas) in Athenian Museums, and in the collection of topographical passages.
- Pieter Rodeck, Admitted 1896—97 as Travelling Student and Gold Medallist of the Royal Academy. Worked at Ionic and Byzantine Architecture, and assisted in the excavations at Athens and Melos, and in supervising the building of the Hostel.
- J. G. C. Anderson, Christ Church, Oxford. Admitted (as Craven University Fellow) 1896—97. Worked at epigraphy, assisted in the excavations in Athens, and travelled in Asia Minor.
- J. W. Crowfoot, Hulmean Exhibitioner of Brasenose College, Oxford. Admitted, on appointment to the Oxford Studentship given by the Managing Committee, 1896—97. Worked at Greek Portraiture, and assisted in the excavations in Athens and Melos.
- W. W. Reid, Of the Universities of Aberdeen and Edinburgh. Admitted, as holder of Blackie Travelling Scholarship, 1896—97. Worked at Modern Greek, and proceeded to Asia Minor and Cyprus. Assisted in the excavations at Athens.
-

ASSOCIATES OF THE SCHOOL.

APPOINTED 1895—1896.

Professor J. B. Bury, Trinity College, Dublin.
Rev. A. H. Cruickshank, The College, Winchester.
Arthur J. Evans, Keeper of the Ashmolean Museum, Oxford.

APPOINTED 1896—1897.

Ambrose Poynter, Worked at subject of Mosaic.
J. E. Brooks, A former Student of the School.
J. L. Myres, A former Student of the School.

RULES AND REGULATIONS

OF THE

BRITISH SCHOOL AT ATHENS.

OBJECTS OF THE SCHOOL.

I. The first aim of the School shall be to promote the study of Greek archæology in all its departments. Among these shall be (i) the study of Greek art and architecture in their remains of every period; (ii) the study of inscriptions; (iii) the exploration of ancient sites; (iv) the tracing of ancient roads and routes of traffic.

II. Besides being a School of Archæology, it shall be also, in the most comprehensive sense, a School of Classical Studies. Every period of the Greek language and literature, from the earliest age to the present day, shall be considered as coming within the province of the School.

III. The School shall also be a centre at which information can be obtained and books consulted by British travellers in Greece.

IV. For these purposes a Library shall be formed and maintained of archæological and other suitable books, including maps, plans, and photographs.

THE SUBSCRIBERS.

V. The following shall be considered as Subscribers to the School :—

- (1) Donors of £10 and upwards.
- (2) Annual Subscribers of £1 and upwards during the period of their subscription.
- (3) Corporate bodies subscribing £50 at one time or £5 annually.

VI. A corporate body subscribing not less than £50 a year, for a term of years, shall, during that term, have the right to nominate a member of the Managing Committee.

VII. A meeting of Subscribers shall be held in July of each year, at which each Subscriber shall have one vote. A subscribing corporate body may send a representative. At this meeting a report from the Managing Committee shall be presented, including a financial statement and selections from the reports of the Director and Students for the season. At this meeting shall also be annually elected or re-elected the Treasurer and the Secretary of the School, two Auditors, and three members of the Managing Committee, in place of those retiring, under Rule XIII. (3).

VIII. Special meetings of Subscribers may, if necessary, be summoned by the Managing Committee.

IX. Subscribers shall be entitled to receive a copy of any reports that may be published by the School, to use the Library, and to attend the public meetings of the School, whenever they may be in Athens.

THE TRUSTEES.

X. The property of the School shall be vested in three Trustees, who shall be appointed for life, except as hereinafter provided. Vacancies in the number of Trustees shall be filled up at the annual meeting of the Subscribers.

XI. In the event of a Trustee becoming unfit, or incapable of acting, he may be removed from his office by a majority of three-fourths of those present at a special meeting of Subscribers summoned by the Managing Committee for that purpose, and another Trustee shall by the same majority be appointed in his place.

XII. In the event of the death or resignation of a Trustee occurring between two annual meetings, the Managing Committee shall have the power of nominating another Trustee to act in his place until the next annual meeting.

THE MANAGING COMMITTEE.

XIII. The Managing Committee shall consist of the following :—

- (1) The Trustees of the School.
- (2) The Treasurer and Secretary of the School.
- (3) Nine Members elected by the Subscribers at the annual meetings. Of these, three shall retire in each year, at first by lot, afterwards by rotation. Members retiring are eligible for re-election.
- (4) The members nominated by corporate bodies under Article VI.

XIV. The Committee shall have control of all the affairs of the School, and shall decide any dispute that may arise between the Director and Students. They shall have power to deprive any Student of the use of the school-building.

XV. The Committee shall meet as a rule once in every two months; but the Secretary or Treasurer may, with the approval of two members of the Committee, summon a special meeting when necessary.

XVI. Due notice of every meeting shall be sent to each member of the Committee by a summons signed by the Secretary. Three members of the Committee shall be a quorum.

XVII. In case of an equality of votes, the Chairman shall have a second or casting vote.

XVIII. In the event of vacancies occurring among the officers or on the Committee between the annual elections, they may be provisionally filled up by the Committee until the next annual meeting.

STUDENTS AND ASSOCIATES.

XIX. The Students shall consist of the following:—

- (1) Holders of travelling fellowships, studentships, or scholarships at any University of the United Kingdom or of the British Colonies.
- (2) Travelling Students sent out by the Royal Academy, the Royal Institute of British Architects, or other similar bodies.
- (3) Other persons who shall satisfy the Managing Committee that they are duly qualified to be admitted to the privileges of the School.

XX. Students attached to the School will be expected to pursue some definite course of study or research in a department of Hellenic studies, and to write in each season a report upon their work. Such reports shall be submitted to the Director, shall by him be forwarded to the Managing Committee, and may be published by the Committee if and as they think proper.

XXI. Intending Students are required to apply to the Secretary. No person shall be enrolled as a student who does not intend to reside at least three months in Greek lands.

XXII. The Managing Committee may elect as Associates of the School any persons actively engaged in study or exploration in Greek lands; and may also elect as honorary members such persons as they may from time to time think desirable.

XXIII. Students, Associates, and honorary members, shall have a right to use the library of the School, and to attend all lectures given in connexion with the School, free of charge.

XXIV. Students shall be expected to reside in the Hostel provided for them, except with the sanction of the Managing Committee. Priority of claim to accommodation in the Hostel shall be determined by the Committee.

THE DIRECTOR.

XXV. The Director shall be appointed by the Managing Committee, on terms which shall be agreed upon at the time, for a period of not more than three years. He shall be eligible for re-election.

XXVI. He shall have possession of the school-building as a dwelling-house; but Students of the School shall have a right to the use of the library at all reasonable times.

XXVII. It shall be his duty (1) to guide and assist the studies of Students and Associates of the School, affording them all the aid in his power, and also to see that reports are duly furnished by Students, in accordance with Rule XX., and placed in the hands of the Secretary before the end of June; (2) to act as Editor of the School Annual.

XXVIII. (a) Public Meetings of the School shall be held in Athens during the season, at which the Director and Students of the School shall read papers on some subject of study or research, and make reports on the work undertaken by the School. (b) The Director shall deliver lectures to Students of the School. At least six of such meetings and lectures shall be held in the course of each session.

XXIX. He may at his discretion allow persons, not Students of the School, to use the library and attend his lectures.

XXX. He shall be resident at Athens from the beginning of November in each year to the end of the following June, but shall be at liberty to absent himself for short periods for purposes of exploration or research.

XXXI. At the end of each season he shall report to the Managing Committee—(i) on the studies pursued during the season by himself and by each Student; (ii) on the state of the School-premises and the repairs needed for them; (iii) on the state of the Library and the purchases of books, &c., which he may think desirable; and (iv) on any other matter affecting the interests of the School.

XXXII. In case of misconduct the Director may be removed from his office by the Managing Committee by a majority of three-fourths of those present at a meeting specially summoned for the purpose. Of such meeting at least a fortnight's notice shall be given.

RULES FOR THE MACMILLAN HOSTEL.

XXXIII. The Hostel shall be managed by the Students for the time being, subject to the control of the Director.

XXXIV. The Director shall have power to exclude a Student from the Hostel in case of misconduct; but such exclusion must be immediately reported to the Managing Committee.

XXXV. The Students shall, until further notice, pay a fixed charge of 15 drachmas (paper) a week for their rooms, this payment to include fire and lighting.

XXXVI. The Committee shall provide a butler (who can act as caretaker while the School is closed), the Students providing such further service as may be necessary.

XXXVII. The Director shall draw up further rules for the internal management of the Hostel; such rules to be subject to the approval of the Managing Committee.

RULES FOR THE LIBRARY.

XXXVIII. The Director shall have power to make rules for the management of the Library, its use by Students, and the like; such rules to be subject to the approval of the Managing Committee.

PUBLICATION.

XXXIX. No publication whatever, respecting the work of the School, shall be made without the previous approval of the Committee.

THE FINANCES.

XL. All money received on behalf of the School beyond what is required for current expenses shall be invested in the names and at the discretion of the Trustees.

XLI. The banking account of the School shall be placed in the names of the Treasurer and Secretary, who shall sign cheques jointly.

XLII. The first claim on the revenue of the School shall be the maintenance and repair of the School-building, and the payment of rates, taxes, and insurance.

XLIII. The second claim shall be the salary of the Director, as arranged between him and the Managing Committee.

XLIV. In case of there being a surplus, a sum shall be annually devoted to the maintenance of the library of the School and to the publication of a report; and a fund shall be formed from which grants may be made for travelling and excavation.

Revised, October, 1897.

MANAGING COMMITTEE, 1897—1898.

EDWIN FRESHFIELD, ESQ., LL.D.	} Trustees,
PROFESSOR JEBB, Litt.D., LL.D., M.P.	
PANDELI RALLI, ESQ.	
D. B. MONRO, ESQ., M.A., Provost of Oriel.	} Appointed by the Subscribers
PROFESSOR WILLIAM RIDGEWAY, M.A.	
SIDNEY COLVIN, ESQ., M.A.	
PROFESSOR ERNEST GARDNER, M.A.	
MISS JANE E. HARRISON, LL.D.	
GEORGE A. MACMILLAN, ESQ.	
J. LINTON MYRES, ESQ., M.A.	
PROFESSOR H. F. PELHAM, M.A., President of Trinity College, Oxford.	
F. C. PENROSE, ESQ., F.R.S.	
J. E. SANDYS, ESQ., Litt.D.	
CECIL HARCOURT SMITH, ESQ., LL.D.	}
PROFESSOR CHARLES WALDSTEIN, Litt.D.	

WALTER LEAF, ESQ., Litt.D., *Hon. Treasurer*, 6, Sussex Place, Regent's Park, N.W.

WILLIAM LORING, ESQ., M.A., *Hon. Secretary*, 2, Hare Court, Temple, E.C.

Bankers.

MESSRS. GLYN, MILLS & Co., Lombard Street.

Director 1897—1898.

DAVID GEORGE HOGARTH, ESQ., M.A., Fellow and late Tutor of Magdalen College, Oxford.

INDEX.

- AGONOTHETES, 195, 196, 197.
- Amphora, Panathenaic, 182 ff.; lowest limit of date, 187 f.; reference to, in classical writers, 188; on coins, *ibid.*; made of metal, 189; artists' signatures on, 192 ff.; unusual formulæ on, 194 f., 198; explanation of, 195, 197; date of change, 198; symbols on, 199.
- Anthas, 109; worship of, 110 ff.
- Anthedon, 110.
- Ανθεμον* of shield of Parthenos, 142.
- Antiparos, 47, 49.
- Apollôn, 120.
- Artemis, torso of, 123.
- Athena Parthenos, statuette of, at Patras, 121; description of, 124 f.; archaeological and artistic value of, 125 ff.; drapery, 125; aegis, 125, 127; Gorgoneion, 125, 129; its method of fastening, 130; shield, 131, 135, 138; comparison with Varvakeion copy, 131; decoration of shield, Pliny's statement, 131 ff.; commentators' views on, 132 ff.; evidence of coins, 133; of vases, 136; decisive evidence of the "Strangford" shield, 137 f.; reconstruction of design on exterior of shield, 141 f.; *ἀνθεμον*, 142; types, *ibid.*; Pliny, xxxvi. 18, 144 f.; base of statuette, 146 f.; date, 147 f.
- Athlothetae, 190, 195.
- BELMORE collection, 48, 65, 67.
- Birth, Macedonian customs relating to, 209 ff.
- Boat of terra-cotta, 22 ff.
- Bourlidia, Roman settlement at, 84.
- Bow, prae-Mycenaean use of, 69, 70.
- Bracelets, 50.
- Bracer, 68.
- Bronze statuettes, Mycenaean, 26 ff.; from Olympia, 150 ff.; of fourth century B.C., 153; Radowitz, 153; Roman, 154.
- Burial, methods of, 7, 36, 39 ff., 56.
- CHARITES, representations of, 172; difference between Sokratic type of, and contemporary nymph type, 173.
- Cimolite, 55 and note.
- Columns, poros, 21; Ionic, 104.
- Crucifixion on gem, 201; on other monuments, 202; earliest type of, its distinguishing features, 204; date of gem, 205.
- DEFIXIONES, 112.
- Demarch's field, excavations in, 31 ff.; plan of, 32; character of masonry, 33; and finds, 34.
- Dioscuri, representations of (*a*) with Helen; at Sparta, 161; in Asia Minor, 162 f.; in Central and Northern Greece, 163 f.; meaning of type, 166; general worship of, 166; by sailors, 167 f.; (*b*) with Helen and Aethra, 165; (*c*) without Helen, on Roman sarcophagi, 166; funereal character of, 167; in Magna Graecia, 162; adaptation of type (*a*), 167.
- Dorian settlements in Melos, 10, 83.
- EPIGENEUS, 114.
- Excavations, Greek law of, 2, 3, 4, note.
- FLINT, 72, 77.
- Foot, Roman linear, 181.
- GEM, Christian, 201 ff.
- Goats, wild, geographical distribution of, in eastern Europe, 70.
- Greek, ancient language, pronunciation of, 216; historical development of, *ibid.*; Prof. Jannaris' view, *ibid.*; evidence of scansion of Homeric poems, 218; explanation of its anomalies, 219.
- Gymnasium at Kynosarges, 89; history of, 89, 103; Ionic capital from, 90 ff.
- HAGIA Kyriaki, 71, 79 ff.
- Helen, worship of, 161, 166; type of cultus-statue, 162.
- Hermes Nomios, 153 f.; Empolaios, 154.
- Hyperes, 110.
- IDOLS, terra-cotta, 22; lead, 51; marble, 56, 21, 27.
- Inscriptions, *Attica*, from Plakka; (Roman) building of gymnasium by Boeotians, 106 ff.; from Kynosarges; sale of two slaves, 112 ff.; Christian, 114 ff.; *ditto*, palimpsest, 117; *ditto*, metrical, 118; *ditto*, sepulchral on cippi, 119 ff. *Miscellaneous*: on roof tile, 75; on Panathenaic vases, 193 ff.; Christian on a gem, 202.
- Ionic capital, from Kynosarges, 90 ff., 103; description of, 94 ff., 103; date of, 90, 103; comparison of, with others, 90 ff.; Penrose's method of drawing spirals in, 96; Athenian type of, before 480 B.C., 97; origin of, 105; Mnesiclean type of, *ibid.*; whence derived, 99, 105; Erechtheion type, 97, 101; Peloponnesian types, 97 ff., 103, 105; their origin; early Asiatic types from Cavalla, 100, 102; from Ephesus, 100 ff.; on Acropolis, 102.
- Ionic column from Kynosarges, height of shaft, 104 f.
- KASTRIANI, roof tile from, 75.
- Kephisia, Roman sarcophagus at, 163 f.
- Kernos, evolution of, 54, 57 ff.; prototype of, 54; two types of, 58; early use of, 59; Melian origin of, 60 ff.

- Khalandri, 61, and note.
 Kittos, signature of, 192; peculiarities of, 193.
 Komia, 72, 75.
 Kopria, 116.
 Kosmetes, functions of, 198; name of, on Panathenaic amphorae, *ibid.*
 Kynosarges, excavation of gymnasium of, 89; finds, *ibid.*; date of, *ibid.*; history of, 89, 103 ff.
 LEAD, vessel from Phylakopi, 12; idol from Antiparos, 50 ff; tablet from Kynosarges, 112.
 Λιθολόγος, 113.
 MACEDONIA, survival of classical customs in, 209 ff.
 Marble head (primitive) in the Ashmolean Museum, 29, 30; pavements, 22, 121 ff.
 Μαρτυράτικα, 213.
 Mat, use of, in making vases, 62, 63.
 Melos, excavations in, 1 ff.; ancient sites in, 71 ff.; geographical description of, 71, 72; town of, 88.
 Moirai, offerings to, in Macedonia, 211 ff.
 Monogram, Christian, 202; Constantinian, 115; cross, 115.
 Mosaic pavements; Roman at Patras, 121; description of, 122; date, 123; at Delos, 182, 191; date of, 183, 186, 192; subject, 182 ff., 191; pebble, at Olympia, 184; in Athens, *ibid.*; date of, 184 f.; references to, in classical authors, 185; cube mosaic, development of, 185; early signed specimens of, at Delos, 186.
 NATRONAGALMATOLITH, 43.
 Nereids, modern Greek idea of, 210 f.
 OBSIDIAN quarries, 72, 77 ff.; instruments, 8, 17, 43, 78, 85; ancient export trade in, 78; factory of, 17, 78.
 Οίκητηριόν, 115.
 PALAEACHORA, plain of, 73 ff.
 Palaeochori, cemetery at, 79; Roman settlement, *ibid.*
 Panathenaia, prizes at, 190 ff.; local, in Magnesia, etc., 196.
 Patras, 121; Psilalonia in, 122; antiquities at, 123; temple of Athena at, 148; history, 147.
 Pavements, marble, 22; schist, 39, 74; marble, in opus sectile, in Athens (*a*) Theatre of Dionysos, 176 ff.; colours and pattern of, 177; dimensions of slabs, 179; (*b*) Odeum of Herodes Atticus, design, and dimensions of slabs, 180; at Olympia, in Temple of Zeus, size, colour and design of, 179 f.; mosaic *ditto*, see under MOSAIC.
 Pelos, site of, 5, 35 f., 73; cist-tombs of, 36, 39; their contents, 42 ff.; prae-Mycenaean character of finds, 42; vases, shape and technique of, 43 ff., 74; relation of stone and earthenware vases, 46 ff.; obsidian objects at, 43; terra-cotta, 42; relation of finds to those in other islands, 46 ff.
 Petralonia, site of, 5.
 Phylakopi, excavations at, 4; site of, 7; primitive settlement at, 7 ff., 13; rock cemetery, 7; fortifications, 8, 11, 12; destroyed by fire, 13, 21; character of masonry, 14; wall chambers, *ibid.*; Mycenaean settlement of, 16 ff., 74; character and shapes of pottery found in, 20 f.; architectural remains, 21 f.; terra-cotta, 22; bronze, 26 ff.; general character of finds, 21 ff., 52 f., 56 f., 74.
 Pile dwellings, 37 ff.
 Porcellanite, 22.
 Poseidon Phylalmios, 110 f.
 Potter's oven, 83, 76.
 Provata, 80..
 RELIEFS, archaistic, 156 ff.; earliest date to which assignable, 157; Dionysos and Maenad on, (?) from Tralles, 157; Dionysos on, 158; Artemis, Ares, and Niké on, 159 f.; Dioscuri and Helen on, 169 ff.; from Tarhuna, 170 ff.; three dancing nymphs, 171 f.; date of, 172; variants of design, 173.
 Roman linear foot, 181; settlements in Melos, 34, 76, 79, 80, 82, 84, 85.
 Roof-tile (inscribed), 75.
 SAMARI, 86 ff.
 Σιδήτης, 120.
 Silver ornaments (primitive), from Antiparos, 50 f.
 Σιτηθίντες of Sparta, 161; objects of society, *ibid.*; *v. sub* Dioscuri.
 Skulls, shape of, in prae-Mycenaean race, 29.
 Slaves, 113.
 Σωφρονίς, 113.
 Sta Chalaka, 81.
 Sta Nychia, 77.
 Stone vases, 21, 37 f., 46 ff.; objects, 21; disks, 64 ff.
 Sulphur mines, 77.
 Συμβόλαι, 109.
 TERRA-COTTA idols, 22; boat, 22 ff.; weight, 38, 42 ff.
 Theudotos, 113.
 Troezen, 110.
 Trough, Stone, from Naxos, 64; in British Museum, 65; use of, 66 ff.
 Tria Pigadia, 77, 86.
 Trymalia, 64.
 Trypeté, 10, 72, 88.
 VASES, 20 ff., 38, 41 ff., 52 f., 57, 62 f., 75, 184, 187 ff., 192.
 WEIGHT, 38, 42 ff.
 Witchcraft, 209 ff.
 Wristguard, prae-Mycenaean in marble, 67 ff.; examples in Britain, 68.
 ZEUS Keraios, 109 ff.; Ithomatas, 150; Sotér of Aegion, 150; youthful type of, 151.

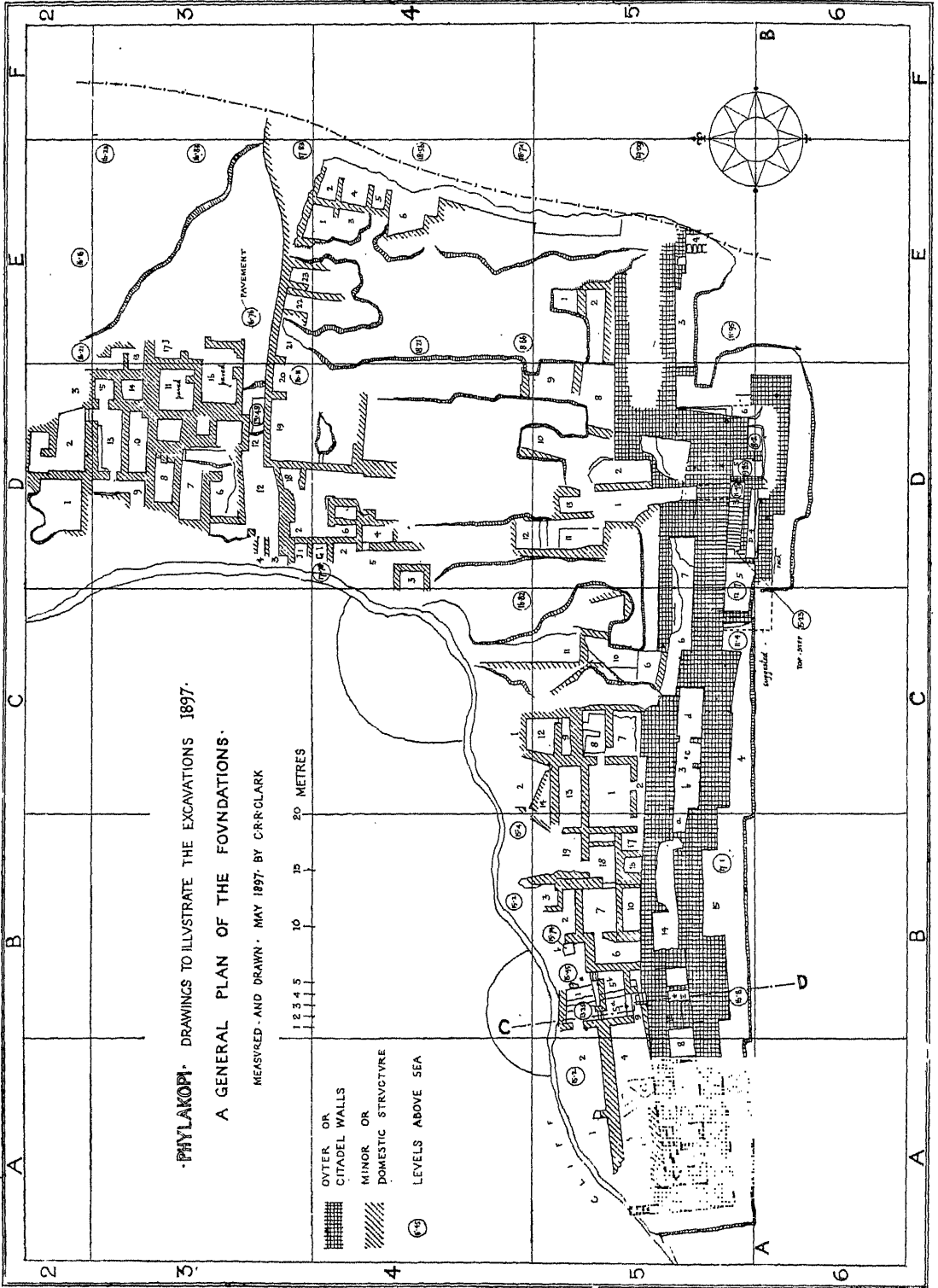

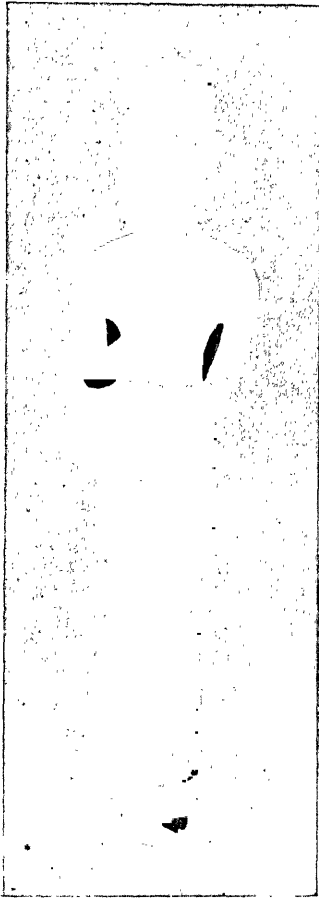

(a)



(b)

(a, b) BRONZE STATUETTE FROM PHYLAKOPI, MELOS.



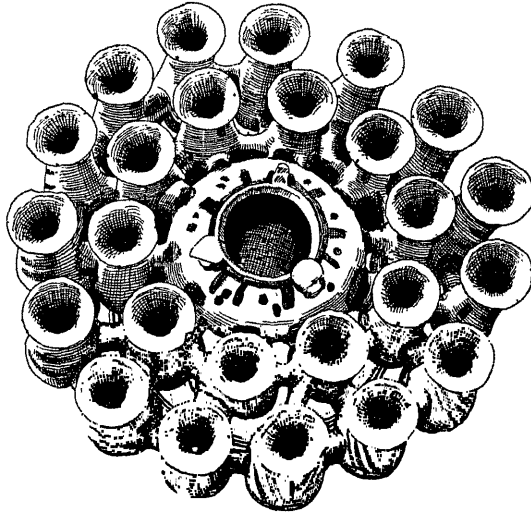

2

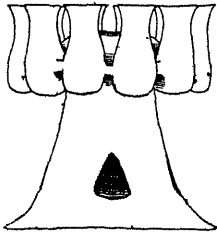

1

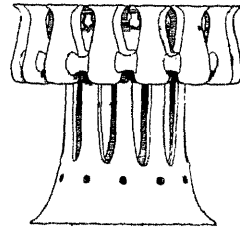

4

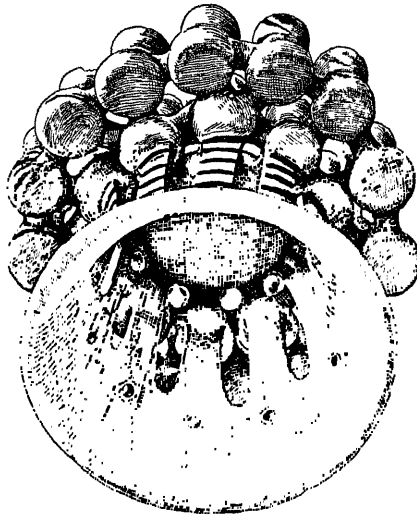

3

1. KERNOS IN THE SÈVRES MUSEUM.

2—4. KERNOS IN THE BRITISH MUSEUM (THREE VIEWS).



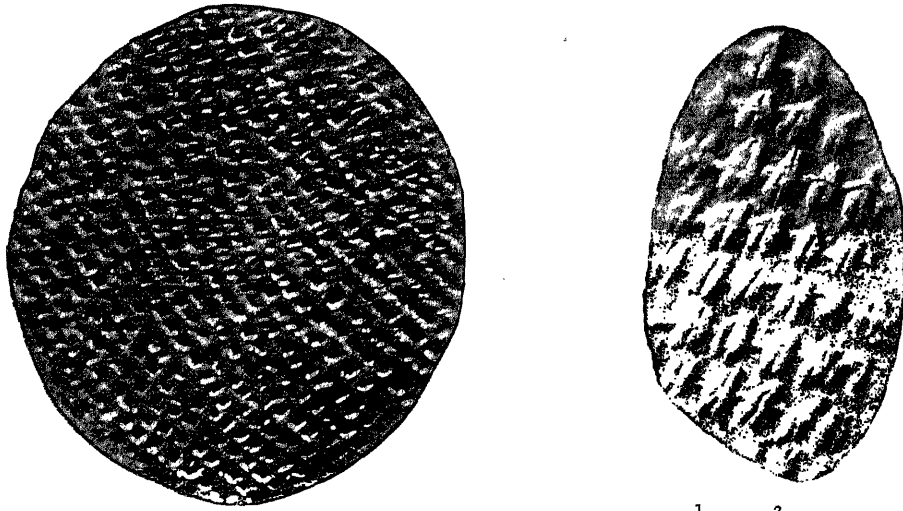

1.

2.

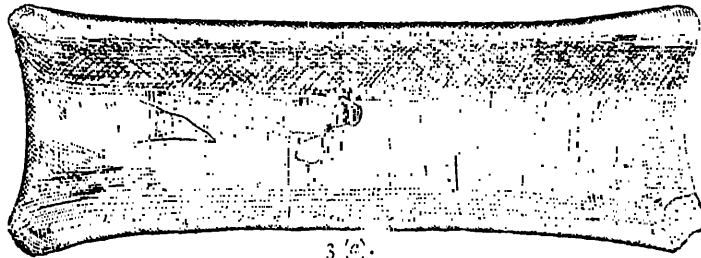

3 (a).

3 (b).

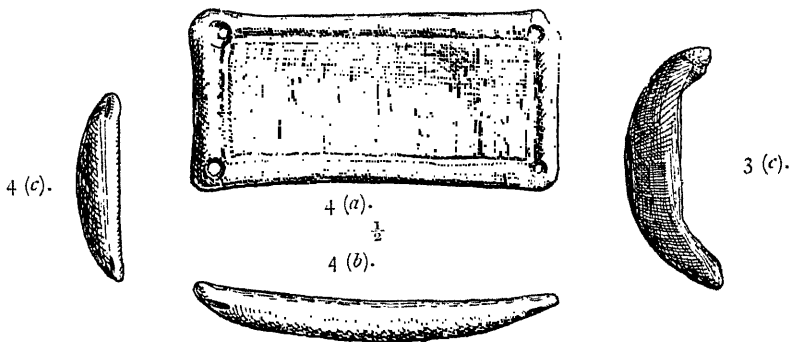
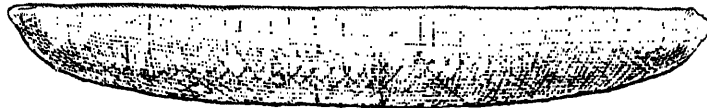

4 (a).

4 (b).

4 (c).

3 (c).

1. BASE OF VASE FROM TOMB IN SYRA, AND
2. FRAGMENT FROM PHYLAKOPI, SHOWING TEXTILE IMPRESSIONS.
3. MARBLE TROUGH FROM AMORGOS.
4. MARBLE PLATE FROM AMORGOS.





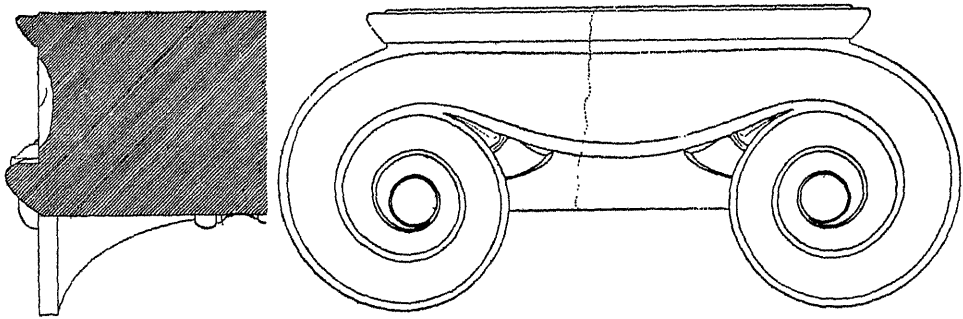
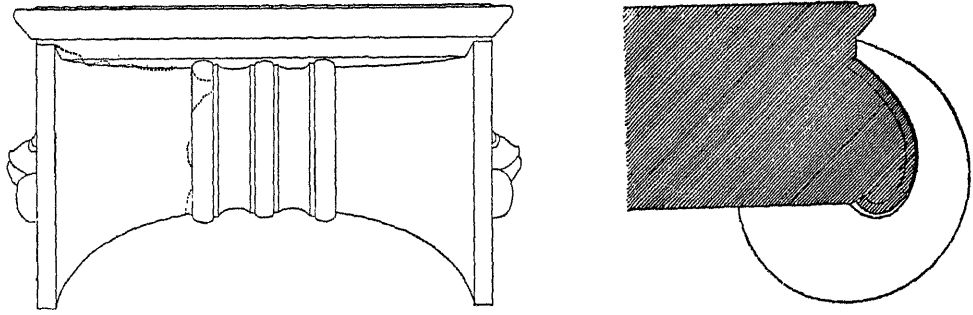

THE IONIC CAPITAL
of the GYMNASIUM of
KYNOSARGES, ATHENS

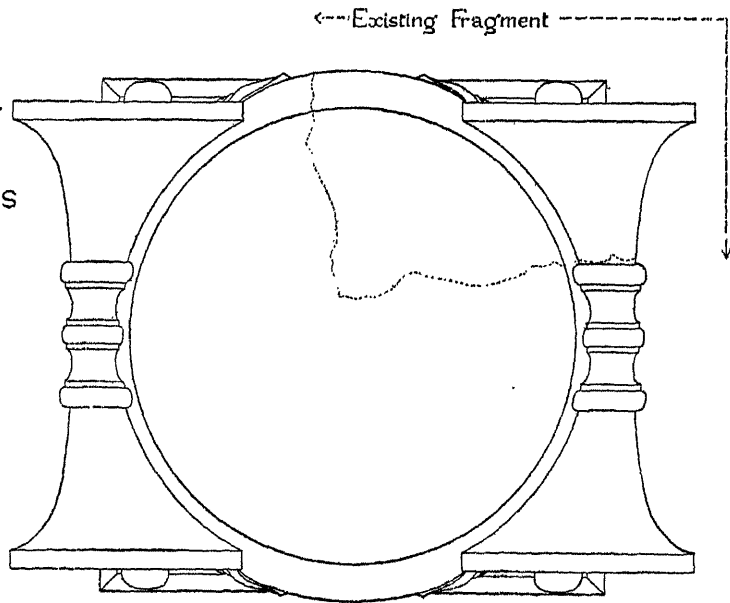

Reiss Rodick

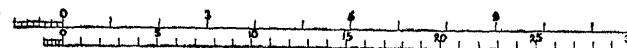
Scale of  Foot Centimetres

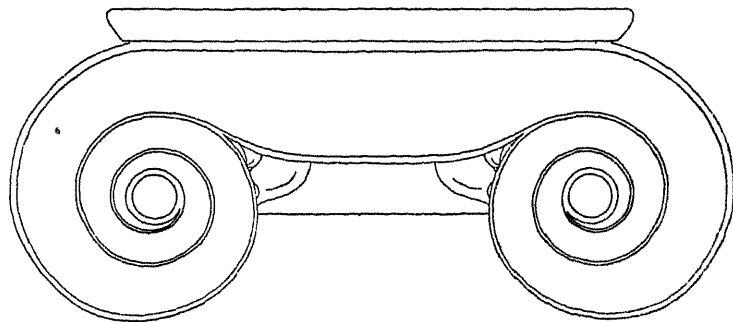
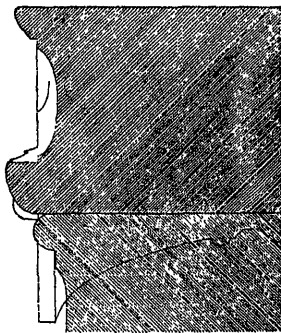
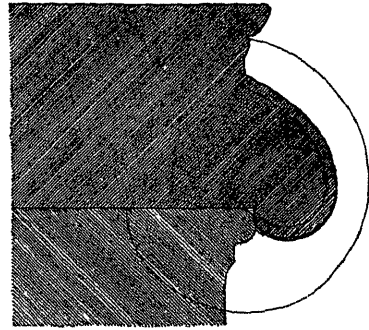
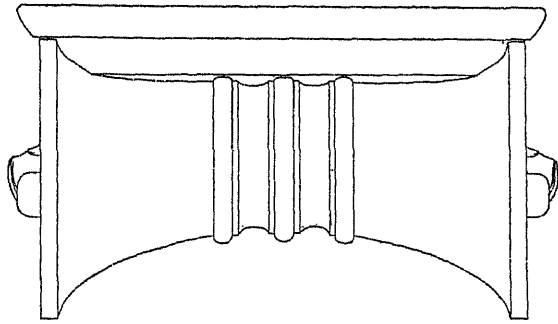

← Upper Diameter →

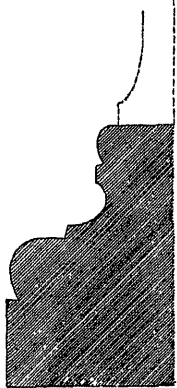

IONIC CAPITAL
now in the THEATRE of
DIONYSOS, ATHENS

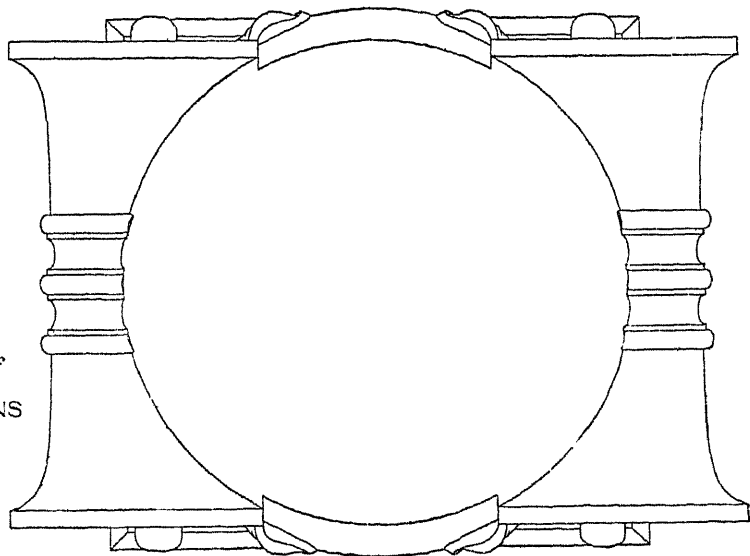

Peter Rodick

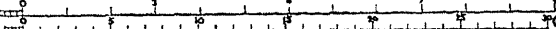
Scale of  Foot Centimetres



COMPARISON OF VOLUTES

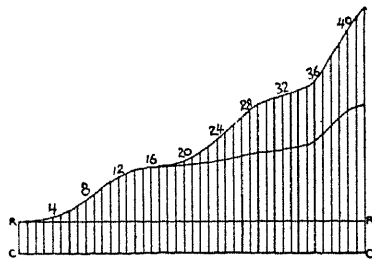
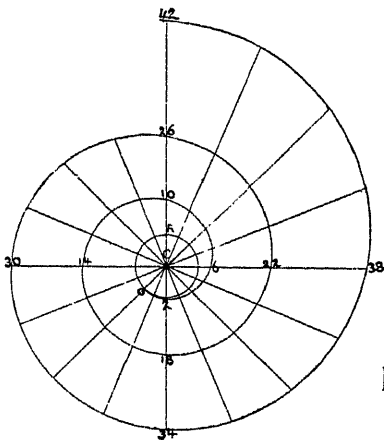

ERECHTHEION and PROPYLAEA

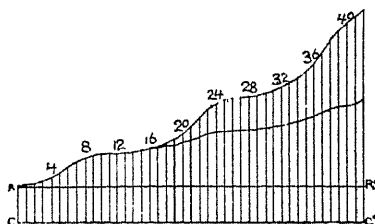
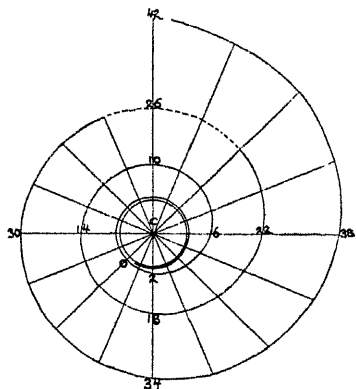

GYMNASIUM of KYNOSARGES

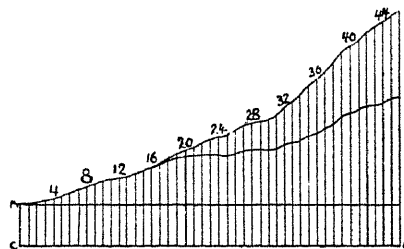
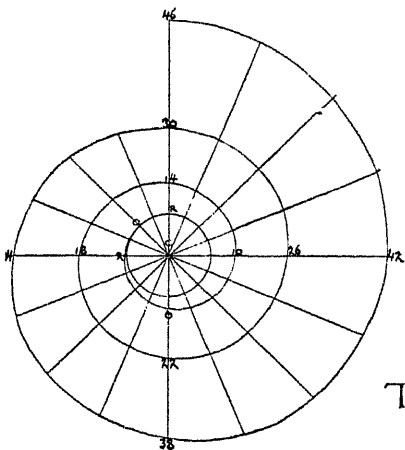

THEATRE of DIONYSOS

Peter Rother

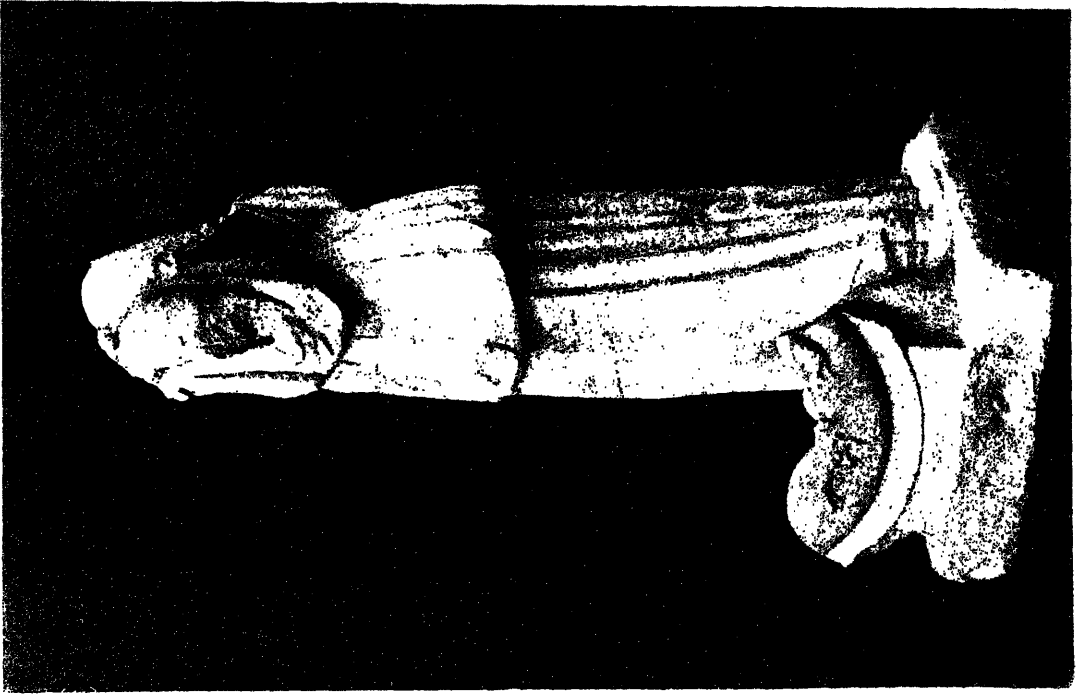

(b)

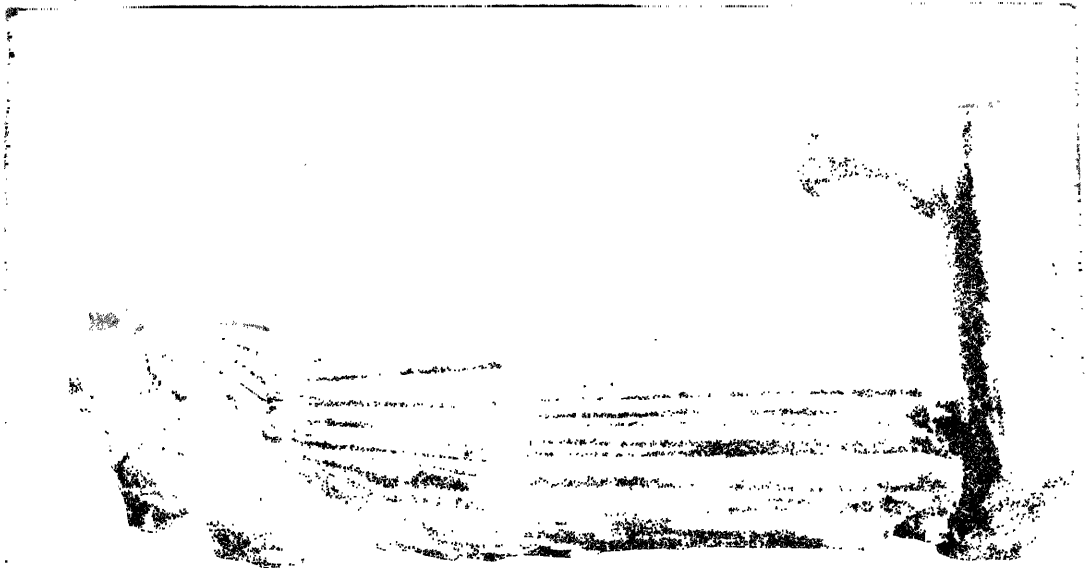

(a)

(a, b) STATUETTE OF ATHENA PARTHENOS, AT PATRAS.





3.

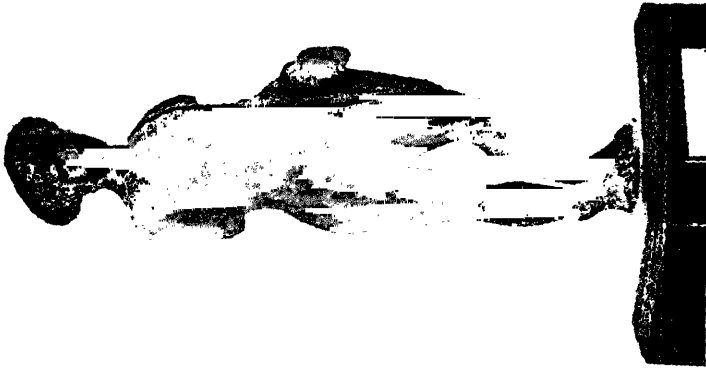

2.



1.

1—3. THREE BRONZE STATUETTES IN ATHENS.

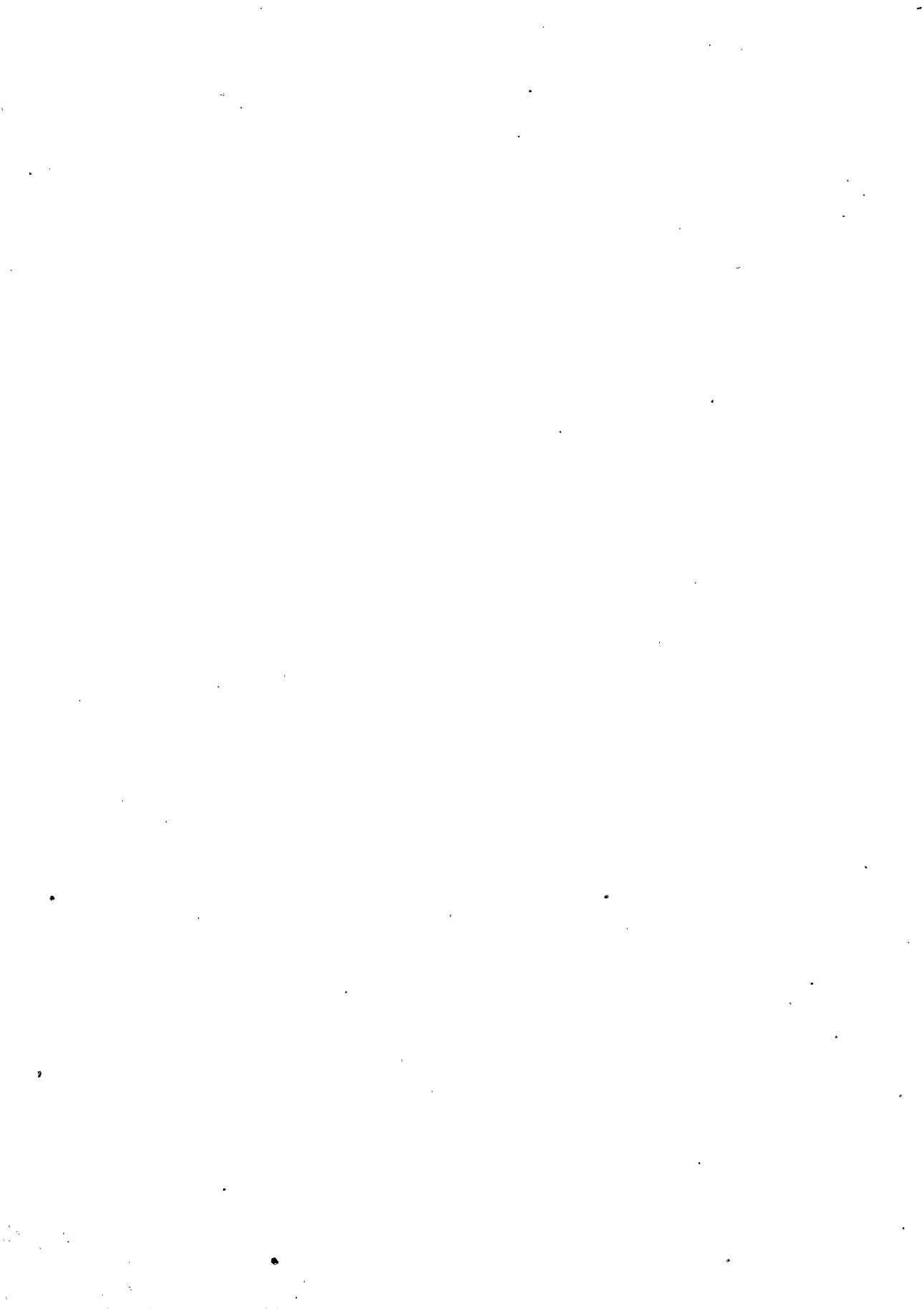



RELIEF AT AÛDIN (TRALLES).



(b)



(a)

(a) RELIEF FROM AÏDIN AT TCHINLI-KIOSK.

(b) RELIEF IN THE POSSESSION OF M. DUVAL AT MORILLON.





(b)



(a)

(a, b) TWO MARBLE RELIEFS AT TCHINLI-KIOSK.





RELIEF FROM THE AFRICAN TRIPOLIS.
(In the possession of Mr. H. Swainson Cooper.)

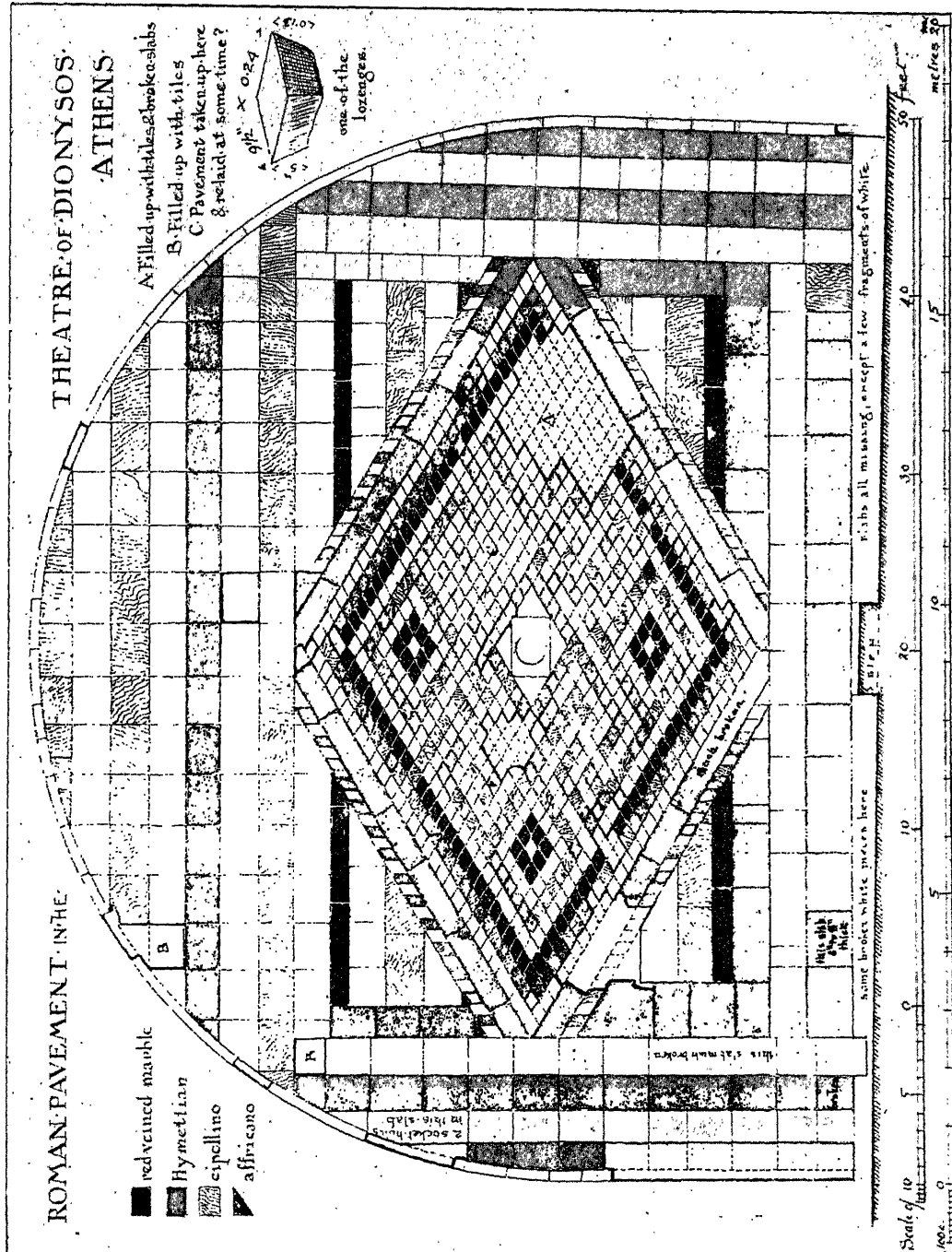

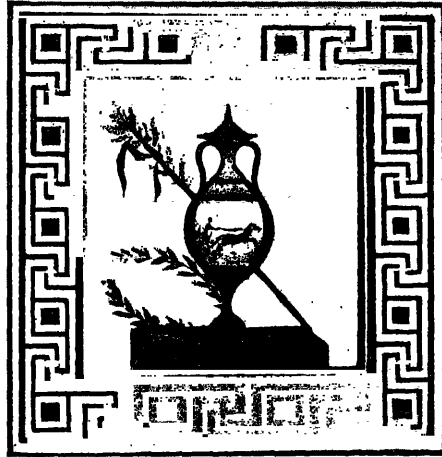

(a)

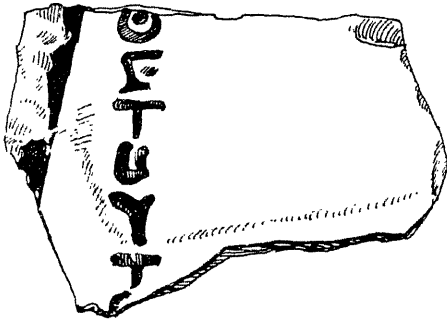

(b)

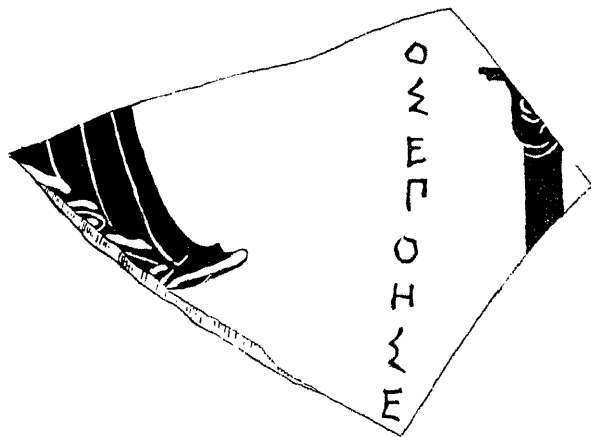

(c)

(a) MOSAIC AT DELOS; (b, c) FRAGMENTS OF PANATHENAIC AMPHORAE,

(b) FROM MELOS; (c) FROM ELEUSIS.

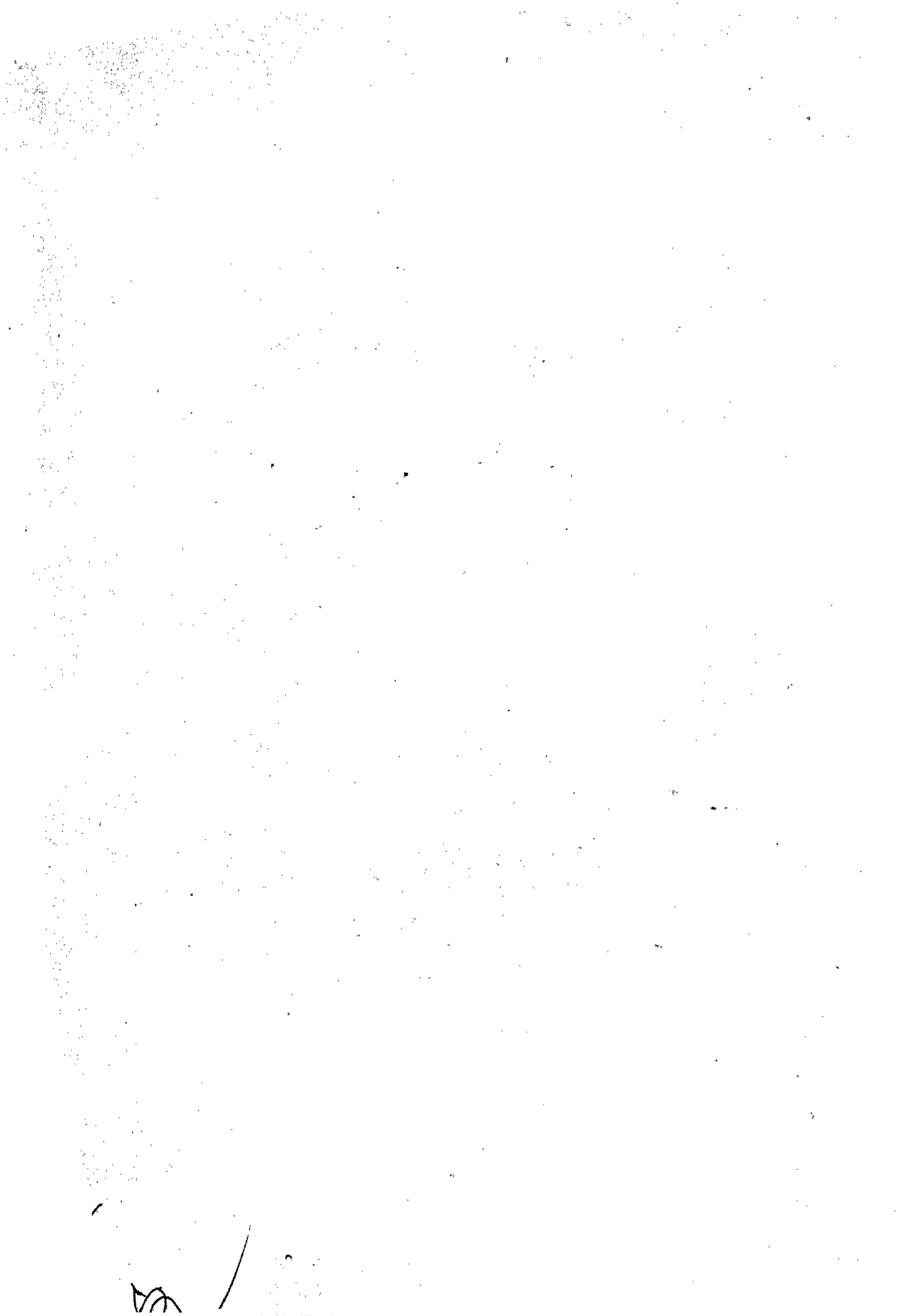

Central Archaeological Library,

NEW DELHI

913.38005-1 A.B.S.A

Call No. ~~A.5301~~ 31292

Author—

Title—*The Annual of the British School at Athens*

Vol. III

Borrower No.	Date of Issue	Date of Return
<i>Sh. B. M. Pandey</i>	<i>26/8/67</i>	<i>12-9-67</i>

"A book that is shut is but a block"

CENTRAL ARCHAEOLOGICAL LIBRARY
GOVT. OF INDIA
Department of Archaeology
NEW DELHI.

Please help us to keep the book
clean and moving.